

Course code: CH101R1
Course title: Chemistry
Pre-requisite(s): Intermediate level chemistry
Co- requisite(s):
Credits: 4 L: 3 T: 1 P: 0
Class schedule per week: 04
Class: B. Tech
Semester /Level: I
Branch: Chemistry
Name of Teacher:

Course Objectives

This course enables the students:

A.	To create concept of chemical bonding in coordination chemistry
B.	To understand the basics of stereochemistry, aromaticity and reaction mechanism of organic molecules
C.	To understand the reaction dynamics and to know different types of catalysis
D	To apprehend the basic principles and the application of vibrational, electronic and NMR spectroscopy
E	To develop knowledge on the physical state and electrochemistry of molecules

Course Outcomes

After the completion of this course, students will be:

1.	Able to explain the bonding in a coordination complex
2.	Able to explain the 3D structure, aromaticity and stereochemistry of organic molecules
3.	Able to predict the rate, molecularity and mechanism of a simple as well as catalytic reaction
4	Able to explain the UV-vis, IR and NMR spectra of unknown molecules
5.	Able to interpret the phase diagram of simple one and two component heterogeneous systems in equilibrium and the electrochemical behavior of the molecules

Syllabus

Module I: Bonding in Coordination Complex**(8 Lecture)**

Introduction to Chemical Bonding, Werner's Theory, Bonding in coordination complexes, Crystal Field Theory, Octahedral, Tetrahedral and Square planar complexes, CFSE, Jahn Teller theorem, Spectral, electronic and magnetic properties of coordination complexes.

Module II: Organic Structure and Reactivity**(8 Lectures)**

Aromaticity, Geometrical isomerism: *cis-trans*, E/Z, and syn-anti isomerism; Optical isomerism & Chirality; Wedge, Fischer, Newmann and Sawhorse projection formulae and interconversions; D/L, R/S nomenclature system; Conformational studies of n-butane.

Addition, Elimination, Substitution and Rearrangement reaction.

Module III: Kinetics and Catalysis:**(8 Lectures)**

Kinetics of Chain, Parallel/Competing/Side, Consecutive reactions; Fast reactions; Outline of Catalysis, Acid-base catalysis, Enzyme catalysis (Michaelis-Menten equation), Important catalysts in industrial processes: Hydrogenation using Wilkinsons catalyst, Phase transfer catalyst.

Module-IV: Spectroscopic Techniques**(8 Lectures)**

Absorption Spectroscopy, Lambert-Beers law, Principles and applications of UV-Visible spectroscopy, Principles and applications of Vibrational spectroscopy; Introduction of NMR spectroscopy.

Module V: Phase and Chemical Equilibrium**(8 Lectures)**

Phase rule: terms involved, Phase diagram of one component (Water) & two component (Pb/Ag) system & their applications; Gibbs Free energy, Van't Hoff equation and Chemical Equilibrium; Nernst Equation, Standard electrode potential, EMF measurement and its application, Batteries and Fuel Cells.

Text books:

1. Huheey, J. E., Inorganic Chemistry: Principles of Structure and Reactivity, 4th edition, Pearson.
2. Morrison, R. N. & Boyd, R. N. Organic Chemistry, Seventh Edition, Pearson
3. Atkins, P. W. & Paula, J. Physical Chemistry, 10th Ed., Oxford University Press, 2014.

Reference books:

1. Lee, J. D. Concise Inorganic Chemistry ELBS, 1991.
2. Mortimer, R. G. Physical Chemistry 3rd Ed., Elsevier (2009).
3. William Kemp, Organic Spectroscopy, 3rd Ed., 2008 Macmillan.

Course Delivery methods
Lecture by use of boards/LCD projectors/OHP projectors
Tutorials/Assignments
Seminars
Mini projects/Projects
Laboratory experiments/teaching aids
Industrial/guest lectures
Industrial visits/in-plant training
Self- learning such as use of NPTEL materials and internets
Simulation

Course Outcome (CO) Attainment Assessment tools & Evaluation procedure**Direct Assessment**

Assessment Tool	% Contribution during CO Assessment
Mid-Sem	25
Assignment	05
Two Quizzes	20
End Sem Examination Marks	50

Assessment Components	CO1	CO2	CO3	CO4	CO5
Mid-Sem	√	√	√		
Assignment	√	√			
Quiz –I	√				
Quiz II				√	
End Sem Examination Marks	√	√	√	√	√

Indirect Assessment –

1. Student Feedback on Faculty
2. Student Feedback on Course Outcome

Mapping between Objectives and Outcomes

Course Outcome #	Program Outcomes			
	PO1	PO2	PO3	PO4
CO1	M	H	L	L
CO2	H	H	M	L
CO3	H	H	H	M
CO4	H	M	H	L
CO5	H	H	H	M

Mapping Between COs and Course Delivery (CD) methods

CD	Course Delivery methods	Course Outcome	Course Delivery Method
CD1	Lecture by use of boards/LCD projectors/OHP projectors	CO1, 2, 3, 4	CD1
CD2	Tutorials/Assignments	CO1, 2, 3, 4	CD1,CD2
CD3	Seminars	CO 2, 3	CD3
CD4	Mini projects/Projects	CO3, 4	CD4
CD5	Laboratory experiments/teaching aids	CO 1, 2, 3	CD5

CD6	Self- learning such as use of NPTEL materials and internets	CO1, 2, 3, 4	CD6
CD7	Simulation	CO2, 4	CD7

Lecture wise Lesson planning Details.

Week No.	Lect. No.	Ch. No.	Topics to be covered	Text Book / References	COs mapped	Methodology used
1-3	L1-L8	1	Bonding in Coordination Complex	T1, R1	1	PPT Digi Class/Chock-Board
3-6	L9-L16	2	Organic Structure and Reactivity	T3, R2	1	-do-
6-8	L17-L24	3	Kinetics & Catalysis	T2	2	-do-
9-11	L25-L32	4	Spectroscopic Techniques	T2, R3	3	-do-
11-14	L33-L40	5	Phase and Chemical equilibrium	T3, R2	4	-do-



BIRLA INSTITUTE OF TECHNOLOGY MESRA
RANCHI, INDIA
CHOICE BASED CURRICULUM
Under Graduate Programme
Department of Chemistry

Subject: CH 101R1- Chemistry

Module I: Bonding in Coordination Complex (8 Lecture)

Introduction to Chemical Bonding, Werner's Theory, Bonding in coordination complexes, Crystal Field Theory, Octahedral, Tetrahedral and Square planar complexes, CFSE, Jahn Teller theorem, Spectral, electronic and magnetic properties of coordination complexes.

TYPES OF BONDS

Atoms may attain a stable electronic configuration in three different ways: by losing electrons, by gaining electrons, or by sharing electrons.

Elements may be divided into three types:

1. Electropositive elements, whose atoms give up one or more electrons readily.
2. electronegative elements. which will accept electrons.
3. Elements which have little tendency to lose or gain electrons.

Three different types of bond may be formed, depending on the electropositive or electronegative character of the atoms involved.

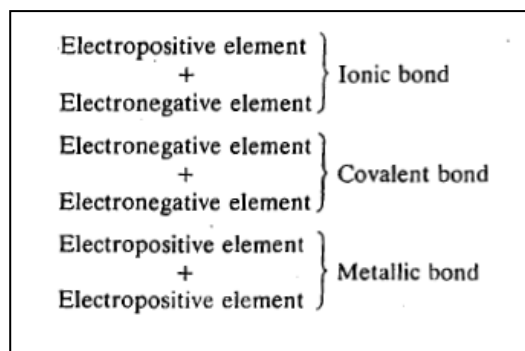

WERNER'S THEORY OF COORDINATION COMPOUNDS

The systematic study of coordination compounds was started by **Alfred Werner** whose pioneering work opened an entirely new field of investigation in inorganic chemistry. He prepared and characterized a large number of coordination compounds and studied their physical, chemical and isomeric behaviour by simple experimental techniques. On the basis of these studies, Werner, in 1898, propounded his theory of coordination compounds.

Table: Series of coloured compounds obtained by the interaction of aqueous CoCl_3 and NH_3

Compound	Colour	Name according to colour	} Isomers
$\text{CoCl}_3 \cdot 6\text{NH}_3$	Yellow	Luteo Complex	
$\text{CoCl}_3 \cdot 5\text{NH}_3$	Purple	Purpureo Complex	
$\text{CoCl}_3 \cdot 4\text{NH}_3$	Green	Praseo Complex	
$\text{CoCl}_3 \cdot 4\text{NH}_3$	Violet	Violeo Complex	

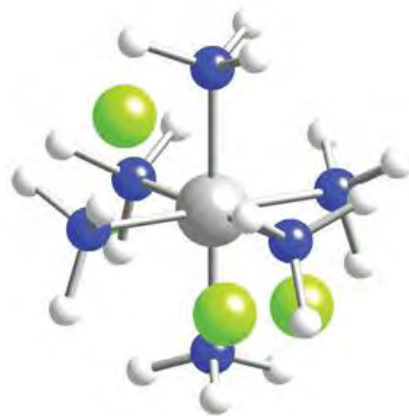

[Co(NH₃)₆]Cl₃

The main postulates of Werner's theory are:

- metals exert two types of linkages; (i) the **primary** or ionizable links which are satisfied by negative ions and equal the oxidation state of the metal, and (ii) the **secondary** or nonionizable links which can be satisfied by neutral or negative ions/groups. The secondary linkages equal the **coordination number** of central metal atom/ion. This number is fixed for a metal.
- the ions/groups bound by the secondary linkages have characteristic spatial arrangements corresponding to different co-ordination numbers. In the modern terminology, such spatial arrangements are called **coordination polyhedra**.

Ligands

The **ligands** are the ions or molecules bound to the central atom/ion in the coordination entity. This is better visualized as the combination of a Lewis acid (the central atom/ion) with a number of Lewis bases (ligands). The atom in the Lewis base that forms the bond to the Lewis acid (central atom/ion) is called **donor atom** (because it donates the pair of electrons required for bond formation). The central atom/ ion is the **acceptor atom/ion** (because it receives the electron pairs from the ligands). Some of the common ligands in coordination compounds are: Br⁻, Cl⁻, CN⁻, OH⁻, O²⁻, CO₃²⁻, NO₂⁻, C₂O₄²⁻, NH₃, CO, H₂O, NH₂CH₂CH₂NH₂ (1,2- ethanediamine). Ligands which can ligate through two different atoms present in it are called **ambidentate ligands**. Examples of such ligands are the NO₂⁻ and SCN⁻ ions. NO₂⁻ ion can coordinate through either the nitrogen or the oxygen atoms to a central metal atom/ion. Similarly, SCN⁻ ion can coordinate through the sulphur or nitrogen atom. Such possibilities give rise to **linkage isomerism** in coordination compounds.

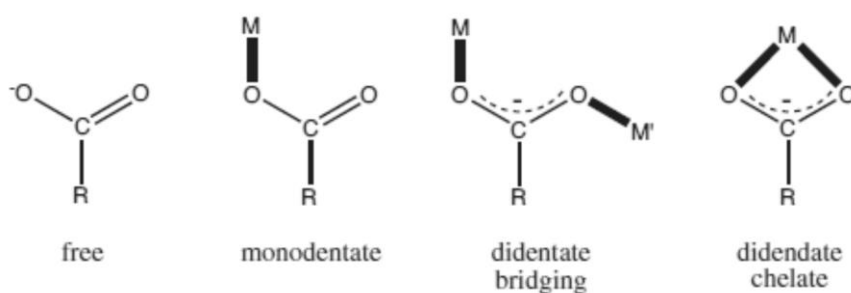

Figure: Metal ion binding options for a carboxylate group, featuring various monodentate and didentate coordination modes.

Types of ligands

Ligands can be classified as monodentate, bidentate, polydentate etc. ligands.

Monodentate ligand

This will coordinate to only site of a metal ion. In other words, it can donate only one pair of electrons to the metal ion.

Example: Cl⁻, Br⁻, SO₄²⁻, NH₂NH₃⁺, NH₃, H₂O

Bidentate ligand

This will occupy two sites of a metal ion. That is, it can attach itself to two positions of a metal ion.

Example: NH₂CH₂CH₂NH₂ etc

Polydentate ligands

These ligands occupy many sites of the same metal ion. Example: EDTA etc.

Table 1.1 Ligands, names, structures and denticity

Name	Formula	Denticity	Abbreviation
Ethylenediamine	NH ₂ CH ₂ CH ₂ NH ₂	2	en
1,10-Phenanthroline		2	phen
<i>o</i> -Phenylenebis(dimethylarsine)		2	diars
1,2-Bis(diphenylphosphino)ethane		2	diphos
acetylacetonate		2	acac

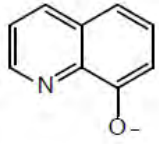
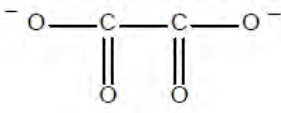
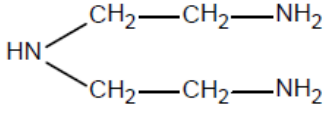
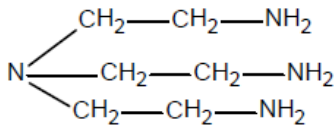
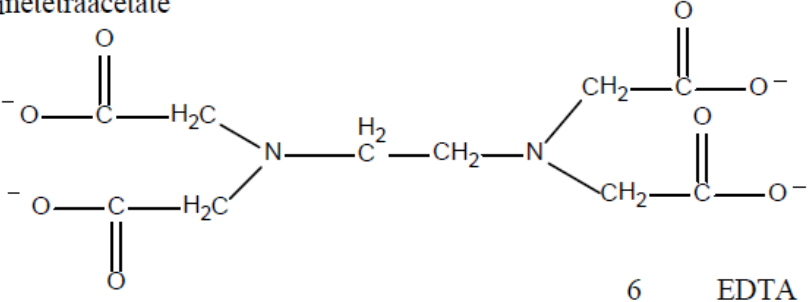
8-Quinolate		2	oxinate
oxalate		2	ox
diethylenetriamine		3	dien
triethylenetetramine		4	tren
ethylenediaminetetraacetate		6	EDTA

Isomerism in Coordination Compounds

Two or more different compounds having the same formula are called isomers. Two principal types of isomerism are known among coordination compounds. Each of which can be further subdivided.

1. Stereoisomerism.

- Geometrical isomerism
- Optical isomerism

2. Structural Isomerism.

- Coordination isomerism
- Ionisation isomerism
- Hydrate isomerism
- Linkage isomerism

Some terms & their definitions:

Enantiomer: Stereoisomers which are not superimposable on their mirror images are called enantiomers.

Diastereoisomers: Stereoisomers which do not possess mirror image relation are called diastereoisomers.

Asymmetric molecule: A molecule without any symmetry (except C_1) is classified as an asymmetric molecule.

Geometric Isomerism: Geometric Isomers differ in the spatial arrangement of atoms within the same structural framework. It is also called cis- trans- isomerism.

Geometric Isomerism for coordination no. 4

Molecular formula	In tetrahedral geometry	In square planer geometry
Ma_4	1 geometric form	1 geometric form
Ma_2b_2, Ma_2bc	1 geometric form	2 geometric form for each (cis & trans) (i-iv)
$Mabcd$	1 geometric form	Three geometric form (v-vii)

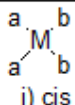
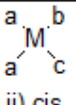
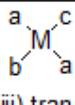
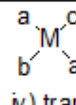
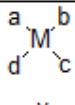
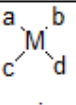
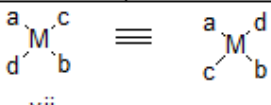
 <p>i) cis</p>	 <p>ii) cis</p>	 <p>iii) trans</p>	 <p>iv) trans</p>
 <p>v</p>	 <p>vi</p>	 <p>vii</p>	

6. Answer: Square planer complexes are generally optically inactive since the molecular plane acts as a plane of symmetry. But optical isomerism may also appear in square planar complexes having an asymmetric ligand.

Geometric Isomerism for coordination no. 6

Molecular formula	In octrahedral geometry
Ma_6, Ma_5b	1 geometric form
$Ma_4b_2, M(aa)_2b_2$ (aa bidentate ligand)	Two isomers (cis and trans isomer)
Ma_3b_3	Two isomers (facial isomer and meridional isomer)

$Ma_4b_2, M(aa)_2b_2$ (aa bidentate ligand)	Ma_3b_3
	e.g. $[Co(NH_3)_3(NO_2)_3]$ and $[Rh(py)_3Cl_3]$

Optical isomerism: A chiral complex is optically active if its structure cannot be superimposed on its mirror image. The condition necessary for a molecule to exhibit Optical isomerism is the absence a rotation reflection axis (S_n).

Easy judgement for optical activity implies the absence of plane or centre of symmetry.

Q. How can you make an optically active square planer complexes? Give example.

Answer: Square planer complexes are generally optically inactive since the molecular plane acts as a plane of symmetry. But optical isomerism may also appear in square planar complexes having an asymmetric ligand.

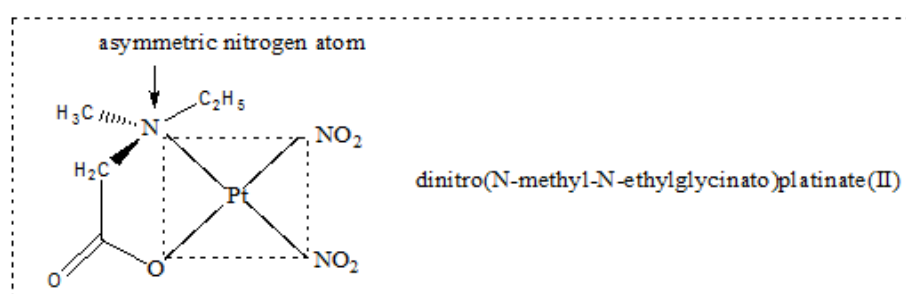

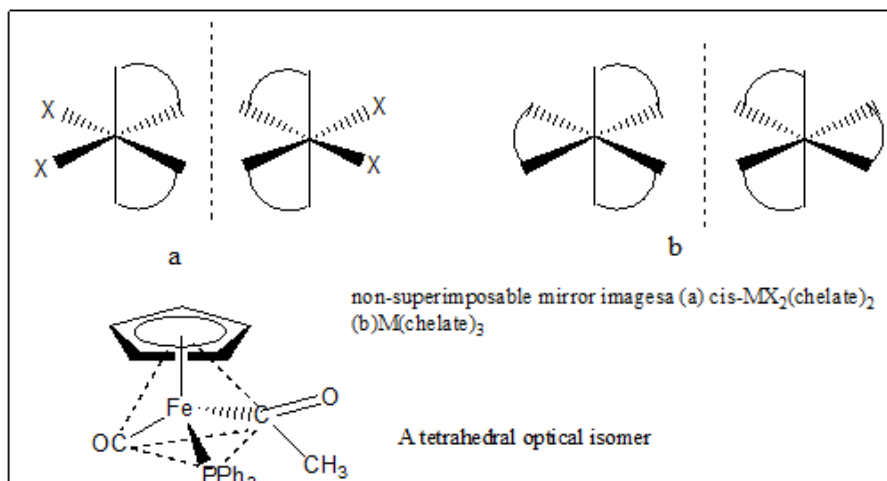

Structural Isomerism

Ionization Isomerism The ionization isomers [Co(NH₃)₅Br]SO₄ and [Co(NH₃)₅SO₄]Br dissolve in water to yield different ions and thus react differently to various reagents:

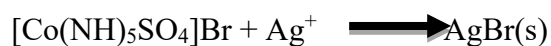
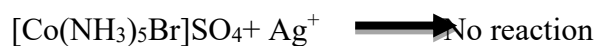
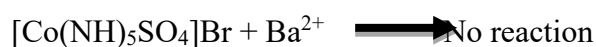
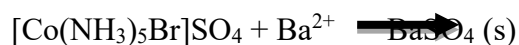

Solvate Isomerism This is a somewhat special case of the above interchange of ligands involving neutral solvate molecules. The best known example involves isomers of "chromic chloride hydrates," of which three are known: [Cr(H₂O)₆]Cl₃, [Cr(H₂O)₅Cl]Cl₂·H₂O, and [Cr(H₂O)₄Cl₂]Cl·2H₂O. These differ in their reactions:

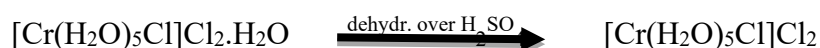

Coordination Isomerism Coordination compounds made up of cationic and anionic coordination entities show this type of isomerism due to the interchange of ligands between the cation and anion entities. Some of the examples are:

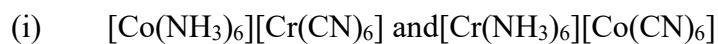

Such isomers are expected to have significant differences in their physical and chemical properties.

A special case of coordination isomerism has sometimes been given the name "polymerization isomerism" since the various isomers differ in formula weight from one another. However, the term is unfortunate since polymerization is normally used to refer to the reaction in which a monomeric unit builds a larger structure consisting of repeating units. The isomers in question are represented by compounds such as $[\text{Co}(\text{NH}_3)_4(\text{NO}_2)_2][\text{Co}(\text{NH}_3)_2(\text{NO}_2)_4]$, $[\text{Co}(\text{NH}_3)_6][\text{Co}(\text{NO}_2)_6]$, $[\text{Co}(\text{NH}_3)_5\text{NO}_2][\text{Co}(\text{NH}_3)_2(\text{NO}_2)_4]_2$, etc. These all have the empirical formula $\text{Co}(\text{NH}_3)_3(\text{NO}_2)_3$, but they have formula weights that are 2, 2, and 3, times this, respectively.

Linkage isomerism

Linkage isomerism occurs with ambidentate ligands. These ligands are capable of coordinating in more than one way. The best known cases involve the monodentate ligands $\text{SCN}^- / \text{NCS}^-$ and $\text{NO}_2^- / \text{ONO}^-$.

For example:

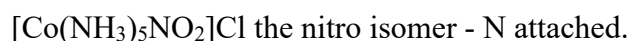
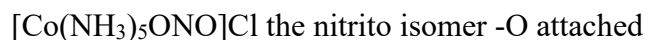

Other Types of Isomerism

Ligand Isomerism Since many ligands are organic compounds which have possibilities for isomerism, the resulting complexes can show isomerism from this source. Examples of isomeric ligands are 1,2-diaminopropane ("propylenediamine," pn) and 1,3-diaminopropane ("trimethylenediamine," tn) or ortho-, meta-, and para-toluidine ($\text{CH}_3\text{C}_6\text{H}_4\text{NH}_2$).

Bonding Theories

Various theoretical approaches to the electronic structure of coordination complexes have been developed. We will discuss some of these bonding models.

Valence Bond Theory

From the valence bond point of view, formation of a complex involves reaction between Lewis bases (ligands) and a Lewis acid (metal or metal ion) with the formation of coordinate covalent

Some Hybridization schemes (δ -only) for complex compounds in common geometry			
Coordination number	Geometry	Hybridization	Examples
2	Linear	sp (s, p_z)	$[\text{Ag}(\text{NH}_3)_2]^+$
3	Trigonal planer	sp^2 (s, p_x, p_y)	$[\text{Ag}(\text{PR}_3)_3]$
4	Tetrahedral	sp^3 (s, p_x, p_y, p_z) d^3s ($d_{xy}, d_{yz}, d_{xz}, s$)	$[\text{Be}(\text{H}_2\text{O})_4]^{2+}$ MnO_4^-
	Square planer	dsp^2 (d_{z^2}, s, p_x, p_y)	$[\text{Ni}(\text{CN})_4]^{2-}$
5	Trigonal bipyramid	dsp^3 ($d_{z^2}, s, p_x, p_y, p_z$)	$[\text{CuCl}_5]^{3-}$
	Square pyramid	dsp^3 ($d_{x^2-y^2}, s, p_x, p_y, p_z$)	$[\text{VO}(\text{acac})_2]$
6	Octahedral	d^2sp^3 ($d_{z^2}, d_{x^2-y^2}, s, p_x, p_y, p_z$)	$[\text{Co}(\text{NH}_3)_6]^{3+}$
	Trigonal prism	$sp^3 d^2$ d^2sp^3 ($d_{yz}, d_{xz}, s, p_x, p_y, p_z$)	$[\text{CoF}_6]^{3-}$ $[\text{Mo}(\text{S}_2\text{C}_2\text{Ph}_2)_3]$

(or dative bonds between them, The model utilizes hybridization of metal s , p , and d valence orbitals to account for the observed structures and magnetic properties of complexes, For example, complexes of Pd(II) and Pt(II) are usually four-coordinate. square planar, and diamagnetic. and this arrangement is often found for Ni(II) complexes as well. Inas much as the free ion in the ground state in each case is paramagnetic (d^8), the bonding picture has to include pairing of electrons as well as ligand-metal-ligand bond angles of 90° . Pauling suggested this occurs via hybridization of one $(n-1)d$, the ns and two np orbitals to form four equivalent dsp^2 hybrids directed toward the corners of a square. These orbitals then participate in covalent σ bonds with the ligand, the bonding electron pairs being furnished by the ligands. The eight electrons that were distributed among the five d orbitals in the free ion are assigned as pairs to the four unhybridized metal d orbitals.

With some ligands, such as Cl^- , Ni(II) forms four-coordinate complexes that are paramagnetic and tetrahedral. For these cases, VB theory assumes the d orbital occupation of the complex to be the same as that of the free ion, which eliminates the possibility that valence-level d orbitals can accept electron pairs from the ligands. Hybrid orbitals of either

the sp^3 or sd^3 type (the latter involving n-level d orbitals) or a combination of the two provide the proper symmetry for the σ bonds as well as allowing for the magnetic properties.

The valence bond picture for six-coordinate octahedral complexes involves d^2sp^3 hybridization of the metal. The specific d orbitals that meet the symmetry requirements for the metal-ligand σ bonds are the d_z^2 and $d_{x^2-y^2}$. As with the four-coordinate d^8 complexes discussed above: the presence of unpaired electrons in some octahedral compounds renders the valence level $(n-1)d$ orbitals unavailable for bonding. This is true, for instance, for paramagnetic $[\text{CoF}_6]^{3-}$. In these cases, the VB model invokes participation of n -level d orbitals in the hybridization.

Examples

In the diamagnetic octahedral complex, $[\text{Co}(\text{NH}_3)_6]^{3+}$, the cobalt ion is in +3 oxidation state and has the electronic configuration $3d^6$. The hybridisation scheme is as shown in diagram. Six pairs of electrons, one from each NH_3 molecule, occupy the six hybrid orbitals. Thus, the complex has octahedral geometry and is diamagnetic because of the absence of unpaired electron. In the formation of this complex, since the inner d orbital ($3d$) is used in hybridisation, the complex, $[\text{Co}(\text{NH}_3)_6]^{3+}$ is called an **inner orbital** or **low spin** or **spinpaired complex**.

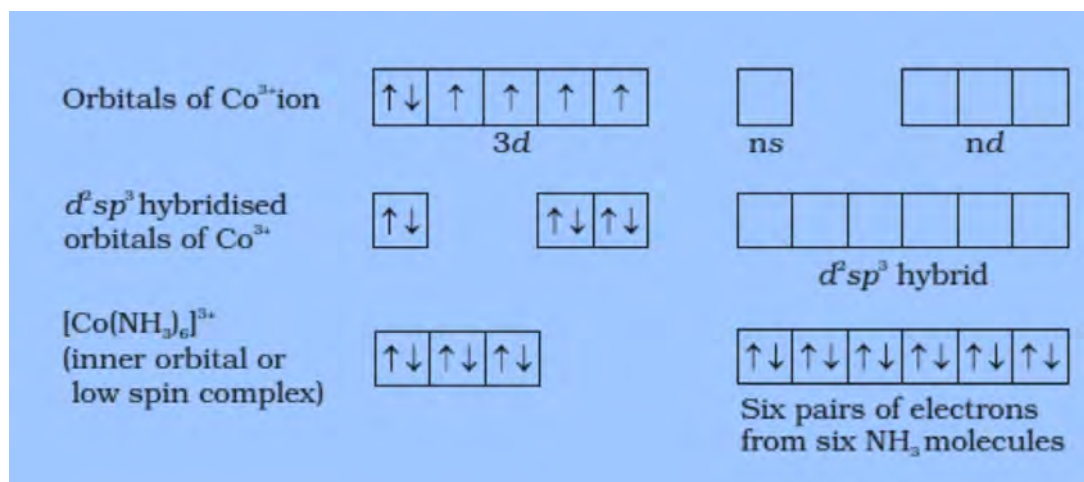

The paramagnetic octahedral complex, $[\text{CoF}_6]^{3-}$ uses outer orbital ($4d$) in hybridisation (sp^3d^2). It is thus called **outer orbital** or **high spin** or **spin free complex**. Thus:

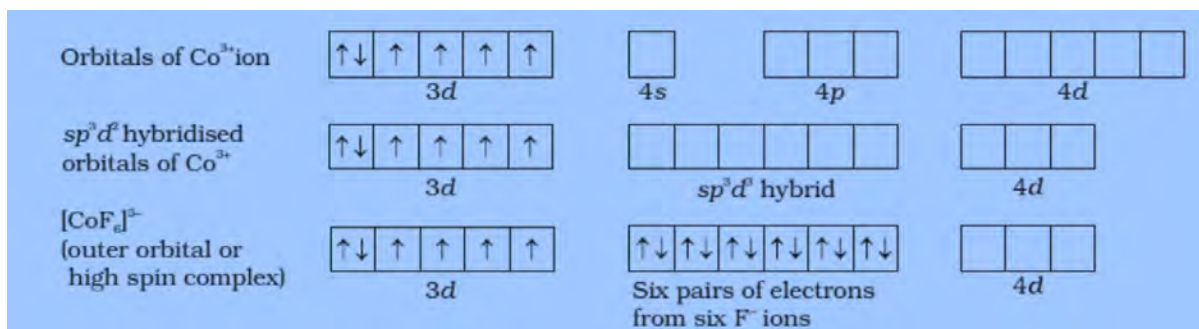

In tetrahedral complexes one s and three p orbitals are hybridised to form four equivalent orbitals oriented tetrahedrally. This is illustrated below for $[\text{NiCl}_4]^{2-}$. Here nickel is in +2 oxidation state and the ion has the electronic configuration $3d^8$. The hybridisation scheme is as shown in diagram. Each Cl^- ion donates a pair of electrons. The compound is paramagnetic since it contains two unpaired electrons. Similarly, $[\text{Ni}(\text{CO})_4]$ has tetrahedral geometry but is diamagnetic since nickel is in zero oxidation state and contains no unpaired electron.

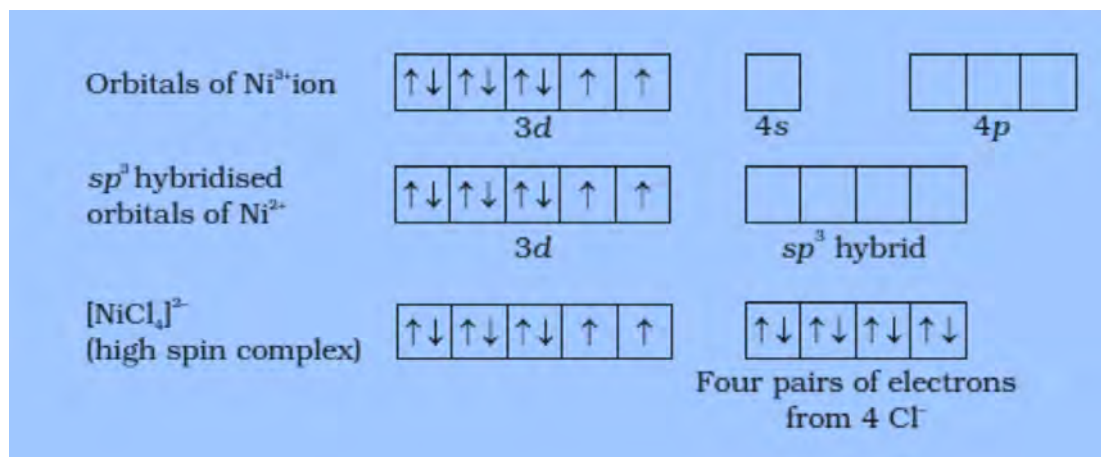

In the square planar complexes, the hybridisation involved is dsp^2 . An example is $[\text{Ni}(\text{CN})_4]^{2-}$. Here nickel is in +2 oxidation state and has the electronic configuration $3d^8$. The hybridisation scheme is as shown in diagram:

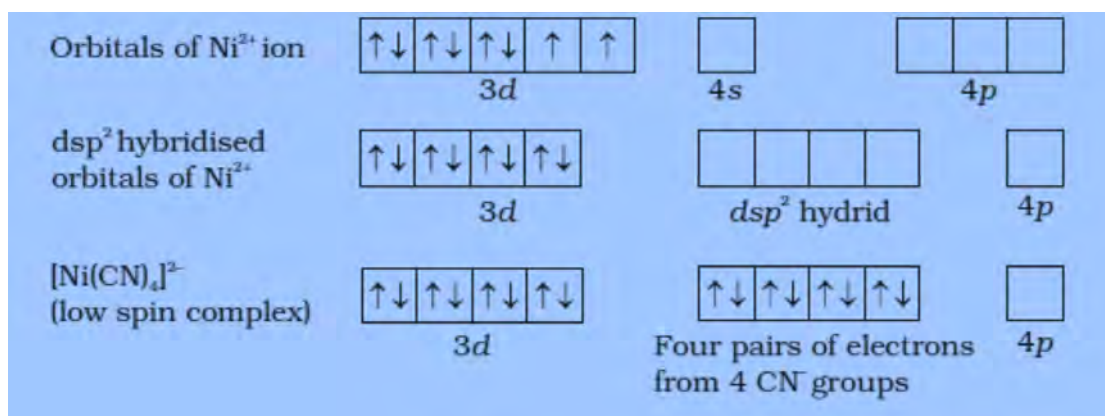

Each of the hybridised orbitals receives a pair of electrons from a cyanide ion. The compound is diamagnetic as evident from the absence of unpaired electron. It is important to note that the hybrid orbitals do not actually exist. In fact, hybridisation is a mathematical manipulation of wave equation for the atomic orbitals involved.

Limitation of the VBT:

1. Fail to explain the colour & characteristics of absorption spectra of complex compounds.
2. Orbital contribution and temperature dependency on magnetic moment of coordination complex are not properly explained by VBT.

3. It is not helpful to predict the mystery of formation of outer or inner orbital coordination complex.
4. VBT fails to predict any distortion in the shapes of the coordination complexes from regular geometry.

Crystal Field Theory

Crystal field theory was originally developed to describe the electronic structure of metal ions in crystals, where they are surrounded by anions that create an electrostatic field with symmetry dependent on the crystal structure. The energies of the d orbitals of the metal ions are split by the electrostatic field, and approximate values for these energies can be calculated. No attempt was made to deal with covalent bonding, because covalency was assumed nonexistent in these crystals. Crystal field theory was developed in the 1930s. Shortly afterward, it was recognized that the same arrangement of electron-pair donor species around a metal ion existed in coordination complexes as well as in crystals, and a more complete molecular orbital theory was developed. However, neither was widely used until the 1950s, when interest in coordination chemistry increased.

When the d orbitals of a metal ion are placed in an octahedral field of ligand electron pairs, any electrons in these orbitals are repelled by the field. As a result, the d_z^2 and $d_{x^2-y^2}$ orbitals, which have e_g symmetry, are directed at the surrounding ligands and are raised in energy. The d_{xy} , d_{xz} and d_{yz} orbitals (t_{2g} symmetry), directed between the ligands, are relatively unaffected by the field. The resulting energy difference is identified as Δ_o (octahedral; older references use $10 Dq$ instead of Δ_o). This approach provides an elementary means of identifying the d-orbital splitting found in coordination complexes.

The average energy of the five d orbitals is above that of the free ion orbitals, because the electrostatic field of the ligands raises their energy. The t_{2g} orbitals are $0.4\Delta_o$ below and the e_g orbitals are $0.6\Delta_o$ above this average energy, as shown in Figure 2. The three t_{2g} orbitals then have a total energy of $-0.4\Delta_o \times 3 = -1.2\Delta_o$ and the two e_g orbitals have a total energy of $+0.6\Delta_o \times 2 = +1.2\Delta_o$ compared with the average. The energy difference between the actual distribution of electrons and that for the hypothetical configuration with all electrons in the uniform (or spherical) field level is called the **crystal field stabilization energy (CFSE)**. The CFSE quantifies the energy difference between the electronic configurations due to (1) the d orbitals experiencing an octahedral ligand field that discriminates among the d orbitals, and (2) the d orbitals experiencing a spherical field that would increase their energies uniformly.

This model does not rationalize the electronic stabilization that is the driving force for metal ligand bond formation. As we have seen in all our discussions of molecular orbitals, any interaction between orbitals leads to formation of both higher and lower energy molecular orbitals, and bonds form if the electrons are stabilized in the resulting occupied molecular orbitals relative to their original atomic orbitals. On the basis of Figure 2, the electronic energy of the free ion configuration can at best be unchanged in energy upon the free ion interacting with an octahedral ligand field; the stabilization resulting from the metal ion interacting with the ligands is absent. Because this approach does not include the lower (bonding) molecular orbitals, it fails to provide a complete picture of the electronic structure.

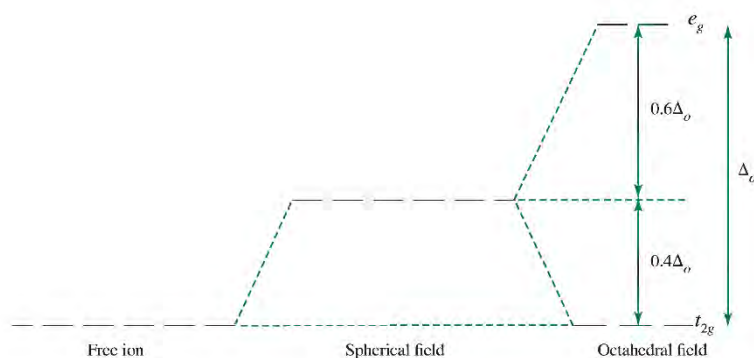
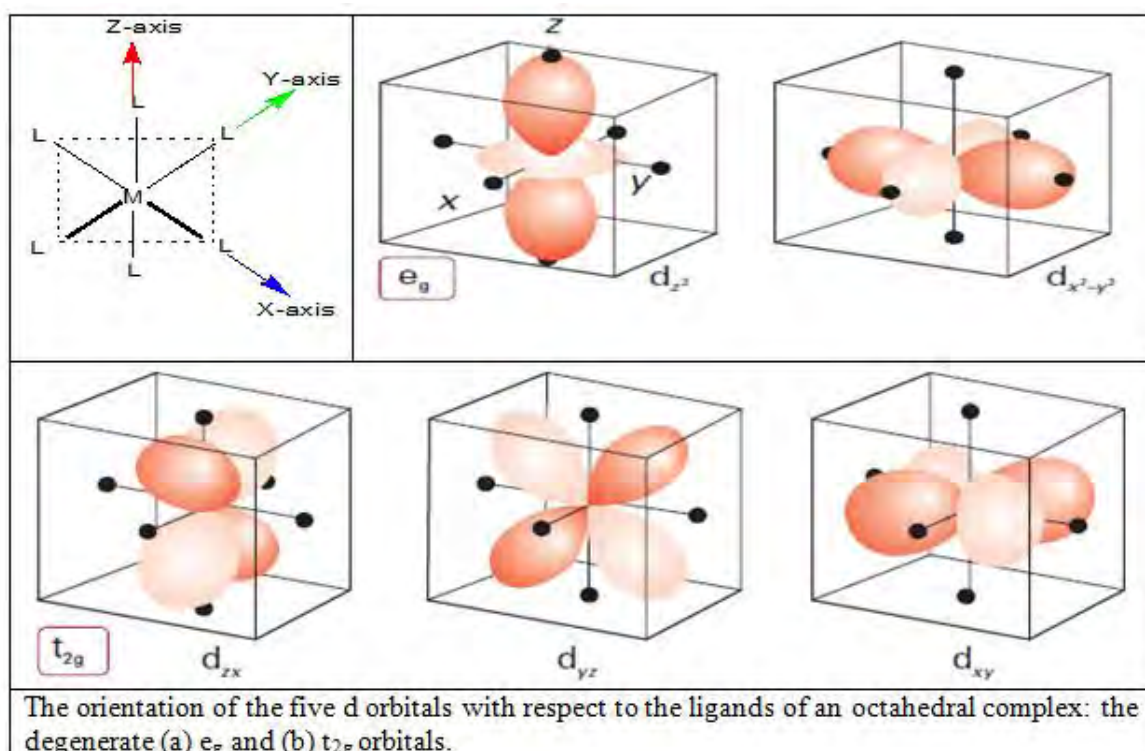
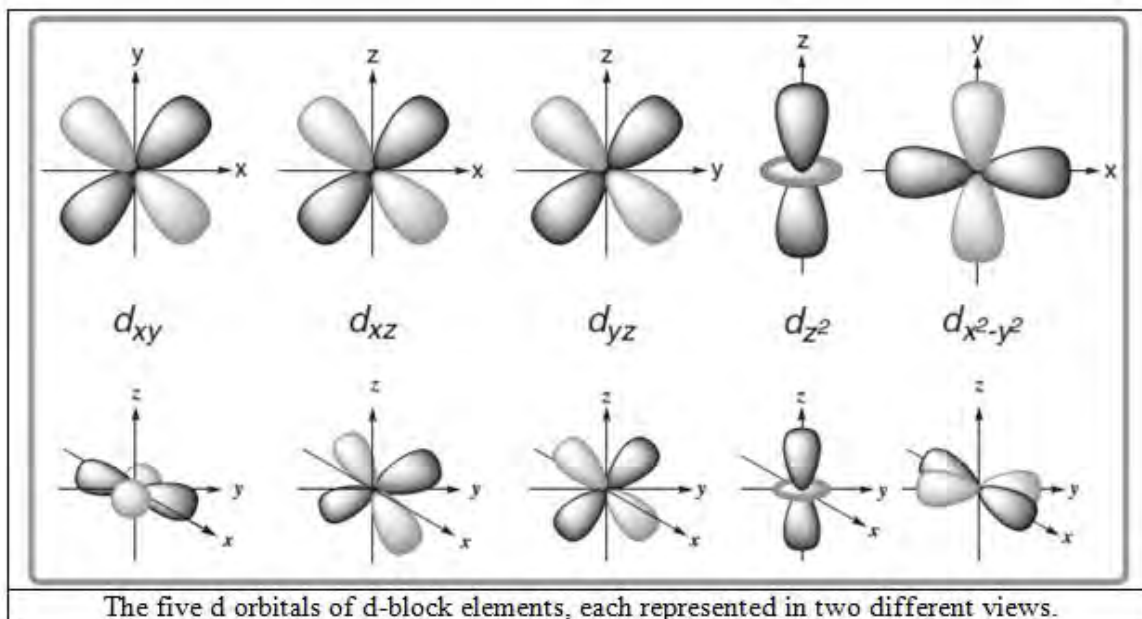

Figure 2: Crystal Field Splitting

Octahedral complexes:





In an octahedral field those d orbital whose lobes are directed along the axis will experience greater interaction from the point charges placed in those directions. These are the $d_{x^2-y^2}$ and d_{z^2} orbitals- the electron of these orbital will experience stronger repulsion from the point charges in the environment i.e. these orbitals will be destabilized & their energy will be raised to some extent.

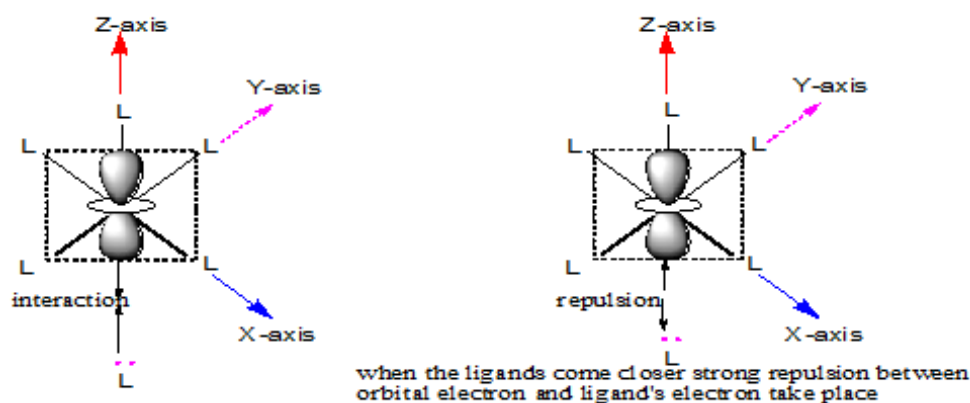

But the remaining three orbital d_{xy} , d_{xz} and d_{yz} have their lobes between the axes (45°) and will be less effected by the point charges in the environment i.e. these orbitals will be subject less electronic repulsion and to maintain the barycentre or center of gravity, energy of these orbitals will be lowered some extent. **The splitting pattern of d orbitals in octahedral field:**

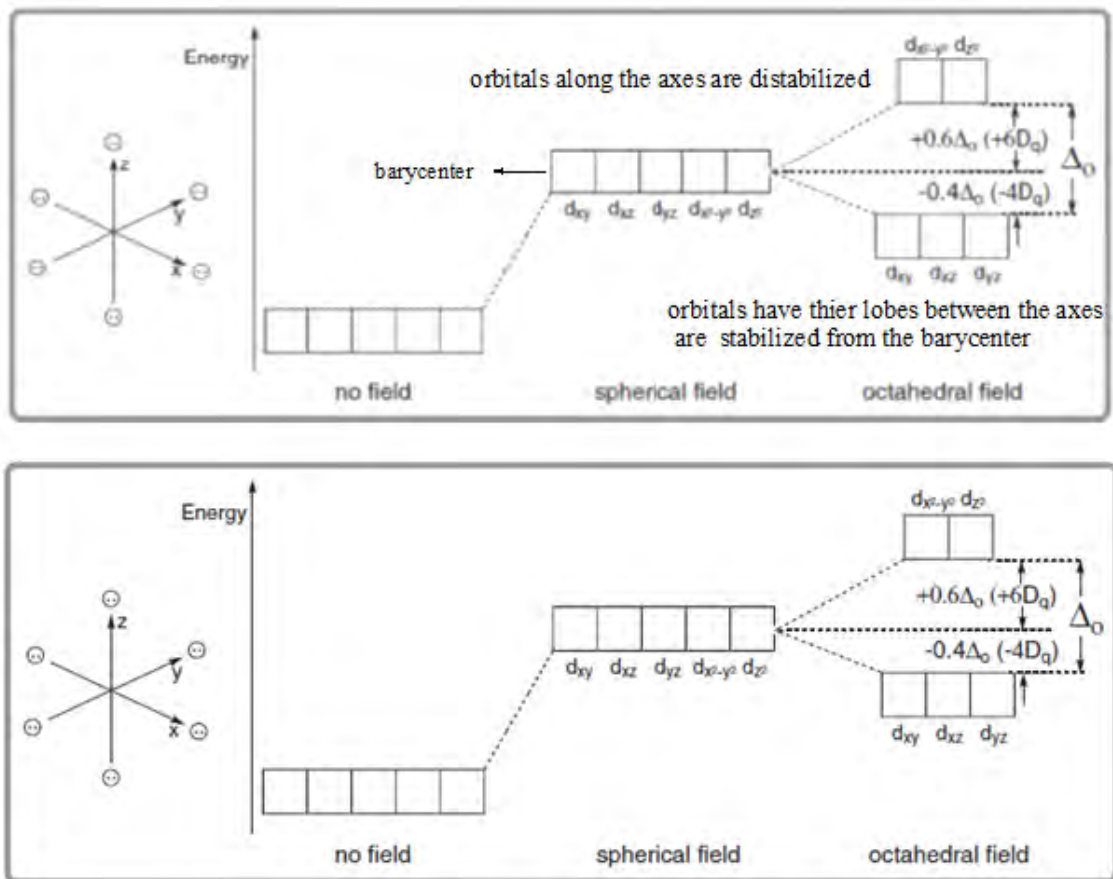

The separation between the t_{2g} and e_g levels is conventionally represented by Δ_o or $10 Dq$.

Tetrahedral Complexes

In tetrahedral coordination entity formation, the d orbital splitting (Fig. 3) is inverted and smaller as compared to the octahedral field splitting. For the same metal, the same ligands and metal-ligand distances, it can be shown that $\Delta_t = -(4/9)\Delta_o$. Consequently, the orbital splitting energies are not sufficiently large for forcing pairing and, therefore, low spin configurations are rarely observed.

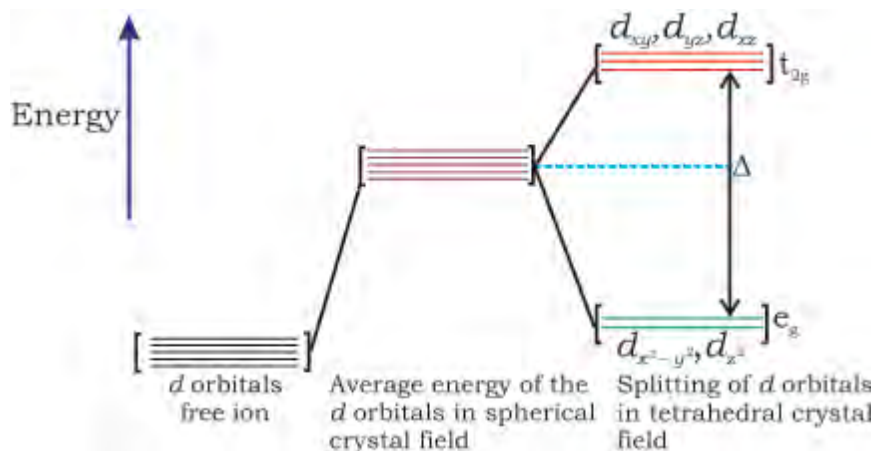

Figure 3. d orbital splitting in a tetrahedral crystal field.

Square Planar Complexes

If two trans ligands in an octahedral ML_6 complex (for example those along the z axis) are moved either towards or away from the metal ion, the resulting complex is said to be tetragonally distorted. Ordinarily such distortions are not favored since they result in a net loss of bonding energy. In certain situations, however, such a distortion is favored because of a Jahn-Teller effect (explained later). A complex of general formula ***trans-MA₂B₄*** also will have tetragonal (D_{4h}) symmetry. For now, we will merely consider the limiting case of tetragonal elongation, a square planar ML_4 complex, for the purpose of deriving its d orbital splitting pattern. Figure 4 illustrates the effect of z -axis stretching on the e_g and t_{2g} orbitals in an octahedral complex, Orbitals having a Z component (the d_{xz} , d_{yz} and d_z^2) will experience a decrease in electrostatic repulsions from the ligands and will therefore be stabilized, At the same time, the "non- z " orbitals will be raised in energy, with the barycenter remaining constant. The overall result is that the e_g level is split into two levels. an upper b_{1g} ($d_{x^2-y^2}$) and a lower a_{1g} (d_z^2) and the t_{2g} set is split into a b_{2g} (d_{xy}) and a doubly degenerate e_g (d_{xz} , d_{yz}). The energy spacing between the b_{2g} and b_{1g} levels is defined as Δ . As in the octahedral case, this splitting is equal to $10Dq$.

The square planar geometry is favored by metal ions having a d^8 configuration in the presence of a strong field, This combination gives low spin complexes with the eight d electrons occupying the low-energy d_{xz} , d_{yz} , d_z^2 and d_{xy} orbitals, while the high-energy $d_{x^2-y^2}$ orbital remains unoccupied. The stronger the surrounding field, the higher the $d_{x^2-y^2}$ orbital will be raised. As long as this level is unoccupied, however, the overall effect on the complex will be stabilization because the lower, occupied orbitals will drop in energy by a corresponding amount. Typical low spin square planar complexes are $[Ni(CN_4)]^{2-}$, $[PdCl_4]^{2-}$, $[Pt(NH_3)_4]^{2+}$, $[PtCl_4]^{2-}$, and $[AuCl_4]^-$, all d^8 species.

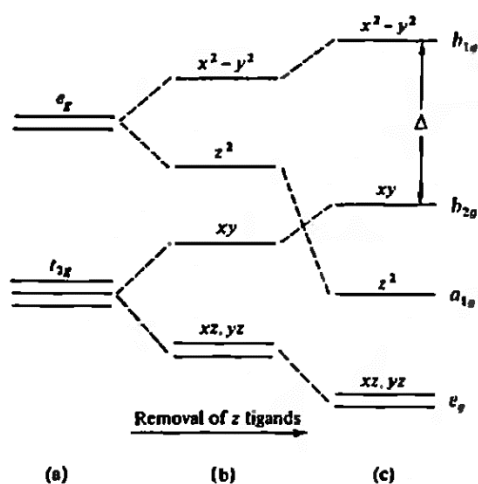
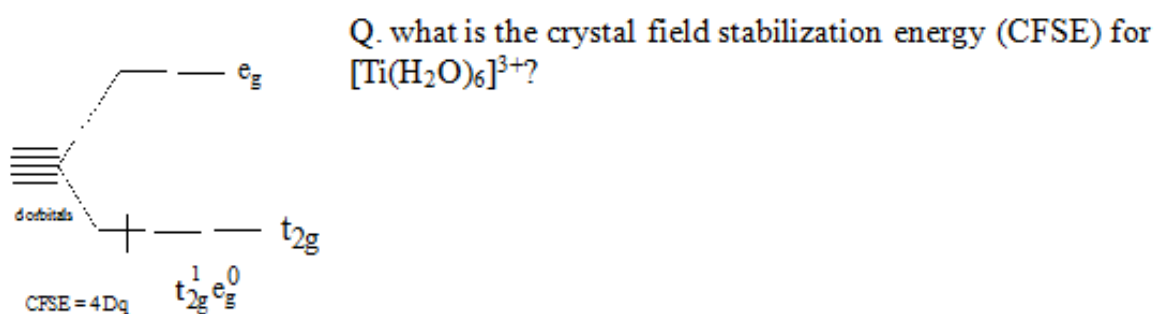

Figure 4. An octahedral complex (a) undergoing z axis elongation such that it becomes tetragonally distorted (b) and finally reaches the square planar limit (c).

Crystal field stabilization energy:

The crystal field stabilization energy (CFSE) is the stability that results from placing a transition metal ion in the crystal field generated by a set of ligands. It arises due to the fact that when the d -orbitals are split in a ligand field (as described above), some of them become lower in energy than before with respect to a spherical field known as the bary-center in which all five d -orbitals are degenerate. For example, in an octahedral case, the t_{2g} set becomes lower in energy than the orbitals in the bary-center. As a result of this, if there are any electrons occupying these orbitals, the metal ion is more stable in the ligand field relative to the bary-center by an amount known as the CFSE. Conversely, the e_g orbitals (in the octahedral case) are higher in energy than in the bary-center, so putting electrons in these reduces the amount of CFSE.



The only one d electron of Ti^{3+} will occupy the lowest available orbital & it is stabilized by the energy $4 Dq$.

Q. what will be the electron arrangement for d^4 and more than d^4 conformation?

Answer: This splitting is affected by the following factors:

- the nature of the metal ion.
- the metal's oxidation state. A higher oxidation state leads to a larger splitting.
- the arrangement of the ligands around the metal ion.
- the nature of the ligands surrounding the metal ion. The stronger the effect of the ligands then the greater the difference between the high and low energy d groups.

There are two possibilities for these type of cases: e.g. for d^4 case

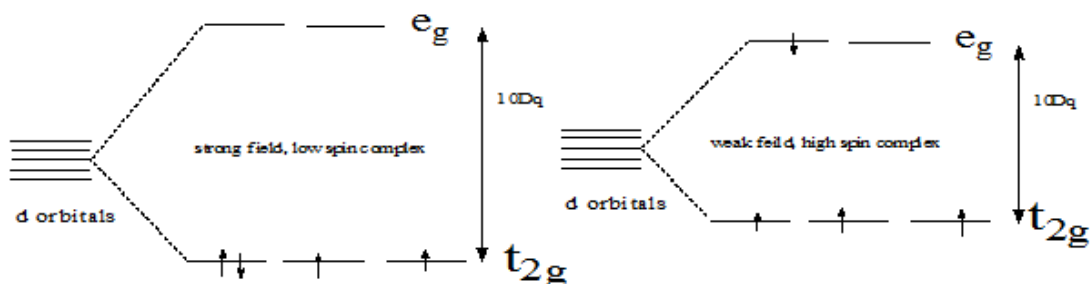

The electron arrangement and CFSE for octahedral complexes				
Configuration	Strong field (low spin)	CFSE	Weak field (high spin)	CFSE
d ¹	t _{2g} ¹ e _g ⁰	4 Dq	t _{2g} ¹ e _g ⁰	4 Dq
d ²	t _{2g} ² e _g ⁰	8 Dq	t _{2g} ² e _g ⁰	8 Dq
d ³	t _{2g} ³ e _g ⁰	12 Dq	t _{2g} ³ e _g ⁰	12 Dq
d ⁴	t _{2g} ⁴ e _g ⁰	16 Dq - p	t _{2g} ³ e _g ¹	6 Dq
d ⁵	t _{2g} ⁵ e _g ⁰	20 Dq - 2p	t _{2g} ³ e _g ²	0 Dq
d ⁶	t _{2g} ⁶ e _g ⁰	24 Dq - 2p	t _{2g} ⁴ e _g ²	4 Dq
d ⁷	t _{2g} ⁶ e _g ¹	18 Dq - p	t _{2g} ⁵ e _g ²	8 Dq
d ⁸	t _{2g} ⁶ e _g ²	12 Dq	t _{2g} ⁶ e _g ²	12 Dq
d ⁹	t _{2g} ⁶ e _g ³	6 Dq	t _{2g} ⁶ e _g ³	6 Dq
d ¹⁰	t _{2g} ⁶ e _g ⁴	0	t _{2g} ⁶ e _g ⁴	0

P = pairing energy
Note that Dq for strong field is higher compare to Dq for weak field.

Crystal field theory and molecular orbital theory were combined into **ligand field theory** by Griffith and Orgel.

Effect of ligands on d orbital splitting (spectrochemical series):

The ligands are sequencing according to their splitting ability, strong field ligand split the d orbitals more (*i. e.* the separation between t_{2g} and e_g is large) compare to weak field ligand and form low-spin complex where as weak field ligand form high spin complex.

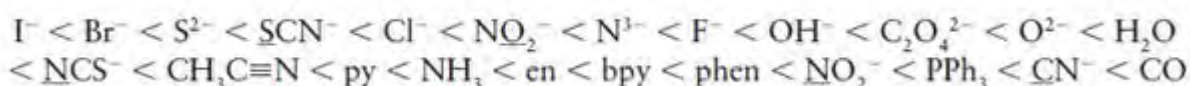

Spinel

The d-block higher oxides Fe₃O₄, Co₃O₄, and Mn₃O₄, and many related mixed-metal compounds, such as ZnFe₂O₄, have very useful magnetic properties. They all adopt the structural type of the mineral spinel, MgAl₂O₄, and have the general formula AB₂O₄. Most oxide spinels are formed with a combination of A²⁺ and B³⁺ cations (that is, as A²⁺ B₂³⁺O₄ in Mg²⁺[Al³⁺]₂O₄), although there are a number of spinels that can be formulated with A⁴⁺ and B²⁺ cations (as A⁴⁺B₂²⁺O₄ as in Ge⁴⁺[Co²⁺]₂O₄). The spinel structure consists of an fcc array of O²⁻ ions in which the A ions reside in one-eighth of the tetrahedral holes and the B ions inhabit half the octahedral holes (**Fig. 5**); this structure is commonly denoted A[B₂]O₄, where

the atom type in the square bracket represents that occupying the octahedral sites. In the inverse spinel structure, the cation distribution is $B[AB]O_4$, with the more abundant B-type cation distributed over both coordination geometries. Lattice enthalpy calculations based on a simple ionic model indicate that, for A^{2+} and B^{3+} , the normal spinel structure, $A[B_2]O_4$, should be the more stable. The observation that many d-metal spinels do not conform to this expectation has been traced to the effect of crystal-field stabilization energies on the site preferences of the ions.

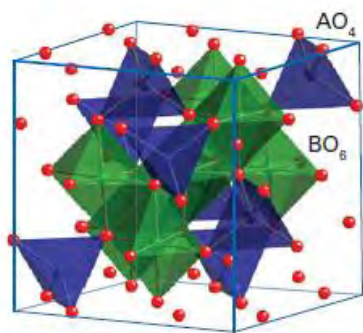

Figure 5. A segment of the spinel(AB_2O_4) unit cell showing the tetrahedral environment of A ions and the octahedral environments of B ions.

The **occupation factor**, λ , of a spinel is the fraction of B atoms in the tetrahedral sites: $\lambda = 0$ for a normal spinel and $\lambda = \frac{1}{2}$ for an inverse spinel, $B[AB]O_4$; intermediate λ values indicate a level of disorder in the distribution, where B-type cations occupy that portion of the tetrahedral sites. The distribution of cations in (A^{2+} , B^{3+}) spinels (**Table 3**) illustrates that for d^0 A and B ions the normal structure is preferred as predicted by electrostatic considerations. **Table 3** shows that, when A^{2+} is a d^6 , d^7 , d^8 , or d^9 ion and B^{3+} is Fe^{3+} , the inverse structure is generally favoured. This preference can be traced to the lack of crystal-field stabilization of the high-spin d^5 Fe^{3+} ion in either the octahedral or the tetrahedral site and the ligand-field stabilization of the other d^n ions in the octahedral site. For other combinations of d-metal ions on the A and B sites the relative ligand-field stabilization energies of the different arrangements of the two ions on the octahedral and tetrahedral sites need to be calculated. It is also important to note that simple ligand-field stabilization appears to work over this limited range of cations.

More detailed analysis is necessary when cations of different radii are present or any ions that are present do not adopt the high-spin configuration typical of most metals in spinels (for instance, Co^{3+} in Co_3O_4 , which is low-spin d^6). Moreover, because λ is often found to depend on the temperature, care has to be taken in the synthesis of a spinel with a specific distribution of cations because slow cooling or quenching of a sample from a high reaction temperature can produce quite different cation distributions.

Table 3. Occupation factor, λ , in some spinels.

	A	Mg ²⁺	Mn ²⁺	Fe ²⁺	Co ²⁺	Ni ²⁺	Cu ²⁺	Zn ²⁺
B		d ⁰	d ⁵	d ⁶	d ⁷	d ⁸	d ⁹	d ¹⁰
Al ³⁺	d ⁰	0	0	0	0	0.38	0	
Cr ³⁺	d ³	0	0	0	0	0	0	0
Mn ³⁺	d ⁴	0						0
Fe ³⁺	d ⁵	0.45	0.1	0.5	0.5	0.5	0.5	0
Co ³⁺	d ⁶					0		0

* $\lambda = 0$ corresponds to a normal spinel; $\lambda = 0.5$ corresponds to an inverse spinel.

The inverse spinels of formula AFe_2O_4 are sometimes classified as **ferrites** (the same term also applies in different circumstances to other iron oxides). The compound $CoAl_2O_4$ is among the normal spinels in **Table 3** with $\lambda = 0$ and thus has the Co^{2+} ions at the tetrahedral sites. The colour of $CoAl_2O_4$ (an intense blue) is that expected of tetrahedral Co^{2+} . This property, coupled with the ease of synthesis and stability of the spinel structure, has led to cobalt aluminate being used as a pigment ('cobalt blue'). Other mixed d-metal spinels that exhibit strong colours, for example $CoCr_2O_4$ (green), $CuCr_2O_4$ (black), and $(Zn,Fe)Fe_2O_4$ (orange/brown), are also used as pigments, with applications that include colouring various construction materials, such as concrete.

EXAMPLE Predicting the structures of spinel compounds

Q Is $MnCr_2O_4$ likely to have a normal or inverse spinel structure?

Answer We need to consider whether there is a ligand-field stabilization. Because Cr^{3+} (d^3) has a large ligand-field stabilization energy ($1.2\Delta_o$) in the octahedral site (but a much smaller one in a tetrahedral field) whereas the high spin d^5 Mn^{2+} ion does not have any LFSE, a normal spinel structure is expected. **Table 3** shows that this prediction is verified experimentally.

The Jahn-Teller Effect

The Jahn-Teller theorem states that degenerate orbitals (those with identical energies) cannot be unequally occupied. To avoid these unfavorable electronic configurations, molecules distort (lowering their symmetry) to render these orbitals no longer degenerate. For example,

an octahedral Cu(II) complex, containing a d^9 ion, would have three electrons in the two e_g levels, as in the center of Figure 6, but an octahedral structure is not observed. Instead, the shape of the complex changes slightly, resulting in changes in the energies of the orbitals that would be degenerate within an octahedral ligand environment. The resulting distortion is usually elongation along one axis, but compression along one axis is also possible. In ideally octahedral complexes that experience Jahn-Teller distortion, the (formally) e^* orbitals change more in energy relative to the (formally) t_{2g} orbitals. More significant Jahn-Teller distortions occur when e^* orbitals would be unequally occupied within an octahedral geometry. Much more modest distortions, sometimes difficult to observe experimentally, occur to prevent unequal occupation of t_{2g} orbitals within an octahedral geometry. The general effects of elongation and compression on d-orbital energies are shown in Figure 7, and the expected degrees of Jahn-Teller distortion for different electronic configurations and spin states are summarized in the following table:

Number of Electrons	1	2	3	4	5	6	7	8	9	10
High-spin Jahn-Teller	w	w		s		w	w		s	
Low-spin Jahn-Teller	w	w		w	w		s		s	

w = weak Jahn-Teller effect expected (t_{2g} orbitals unevenly occupied); s = strong Jahn-Teller effect expected (e_g orbitals unevenly occupied); No entry = no Jahn-Teller effect expected.

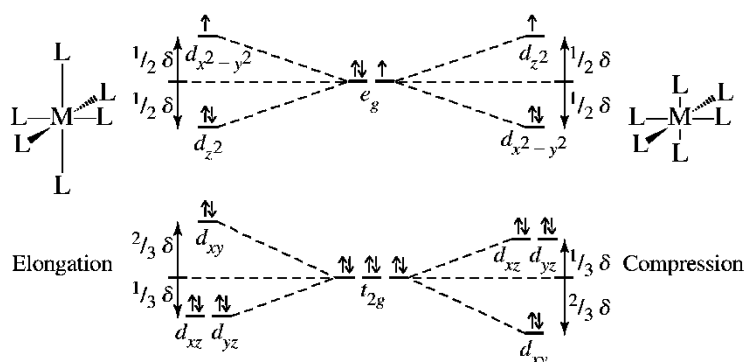
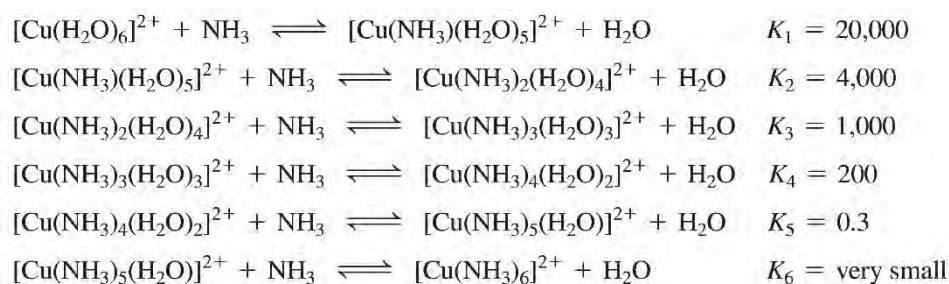

Figure 7. Jahn-Teller Effect on a d^9 Complex. Elongation along the z axis is coupled with a slight decrease in bond length for the other four bonding directions. Similar changes in energy result when the axial ligands have shorter bond distances. The resulting splits are larger for the e_g orbitals than for the t_{2g} orbitals. The energy differences are exaggerated in this figure.

Significant Jahn-Teller effects are observed in complexes of high-spin Cr(II) (d^4), high-spin Mn(III) (d^4), Cu(II) (d^9), Ni(III) (d^7), and low-spin Co(II) (d^7). Low-spin Cr(II) complexes feature tetragonal distortion. Cu(II) complexes generally exhibit significant Jahn-Teller

effects; the distortion is most often elongation of two bonds. Elongation, which results in weakening of some metal- ligand bonds, also affects equilibrium constants for complex formation. For example, *trans*-Cu(NH₃)₄(H₂O)₂]²⁺ is readily formed in aqueous solution as a distorted octahedron with two water molecules at greater distances than the ammonia ligands; liquid ammonia is the required solvent for [Cu(NH₃)₆]²⁺ formation. The formation constants for these reactions show the difficulty of putting the fifth and sixth ammonias on the metal:



Which factor is the cause and which the result is uncertain, but the bottom line is that octahedral Cu(II) complexes are difficult to synthesize with some ligand sets because the bonds to two trans ligands in the resulting complexes are weaker (longer) than the other bonds to the ligands. In fact, many Cu(II) complexes have square-planar or nearly square-planar geometries, with tetrahedral shapes also possible. [CuCl₄]²⁻ exhibits cation-dependent structures ranging from tetrahedral through square planar to distorted octahedral.

Magnetic properties:

A brief knowledge is required for understanding the electronic spectroscopy of transition metal complexes. Additional and complementary information can be provided by magnetic measurement because for the partially filled d or orbitals of transition metal, a range of magnetic properties can be expected, depending on the oxidation state, electronic configuration and coordination number of the central metal.

Classification of substance according to magnetic properties:

Diamagnetism: When any substance is placed in an external magnetic field, there is an induced circulation of electrons producing a net magnetic moment aligned in opposition to the applied field. This is the diamagnetic effect and it arises from paired electrons within a sample, since all compounds contain some paired electrons, diamagnetism is a universal property of matter. If a substance has only paired electrons, this effect will dominate, the material will be classified as diamagnetic, and it will be slightly repelled by a magnetic field.

Paramagnetism: It is produced by unpaired electrons in a sample. The spins and orbital motions of these electrons give rise to permanent molecular magnetic moments that tend to align themselves with an applied field, Because it is much larger than the diamagnetic effect, the paramagnetic effect cancels any repulsions between an applied field and paired electrons in a sample, Thus even substances having only one unpaired electron per molecule will show a net attraction into a magnetic field. The paramagnetic effect is observed only in the presence of an external field.

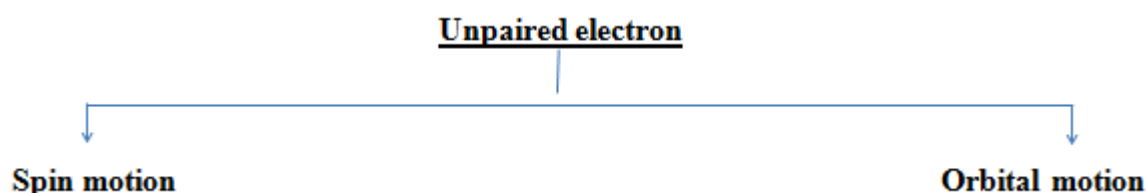

There are three possible modes of coupling between those components: spin-spin, orbital-orbital and spin-orbital. For some complexes, particularly those of the lanthanides, we must consider all three types of coupling. The theoretical paramagnetic moment for such a complex is given by

$$\mu = g[J(J + 1)]^{1/2}$$

Where J is the total angular momentum quantum number and g is the L and splitting factor for the electron, defined as

$$g = 1 + \frac{J(J+1) + S(S+1) - L(L+1)}{2J(J+1)}$$

The value of J depends on the total orbital angular momentum quantum number L and the total spin angular momentum quantum number S .

Magnetic properties of some compound of lanthanides metals at room temperature (300 K).

Central metal	Number of 'f' electrons	Ground state	compound	$\mu(\text{expt})\text{BM}$	$\mu(\text{calc})\text{BM}$
Ce^{3+}	1	$^2\text{F}_{5/2}$	$\text{Ce}_2\text{Mg}_3(\text{NO}_3)_6 \cdot 24\text{H}_2\text{O}$	2.28	2.54
Gd^{3+}	7	$^8\text{S}_{3/2}$	$\text{Gd}_2(\text{SO}_4)_3 \cdot 8\text{H}_2\text{O}$	7.91	7.94
Yb^{3+}	13	$^2\text{F}_{7/2}$	$\text{Yb}_2(\text{SO}_4)_3 \cdot 8\text{H}_2\text{O}$	4.86	4.50

$\mu(\text{calculated}) \text{ B.M.}$ is calculated by $\mu = g[J(J + 1)]^{1/2}$ formula

For complexes in which spin-orbit coupling is non-existent or negligible but spin and orbital contributions are both significant, the predicted expression for μ is

$$\mu = [4S(S + 1) + L(L + 1)]^{1/2}$$

When the orbital contribution is minimal and could be ignored. Hence, $L = 0$ and in this condition, the previous equation reduces to

$$\mu = [4S(S + 1)]^{1/2} = 2[S(S + 1)]^{1/2} \text{ BM}$$

This is known as the spin-only formula for magnetic moment. By recognizing that S will be related to the number of unpaired electrons (n) by $S = n/2$, the expression may be further simplified to

$$\mu = [n(n + 2)]^{1/2} \text{ BM}$$

Co³⁺ octahedral complex with strong field ligands

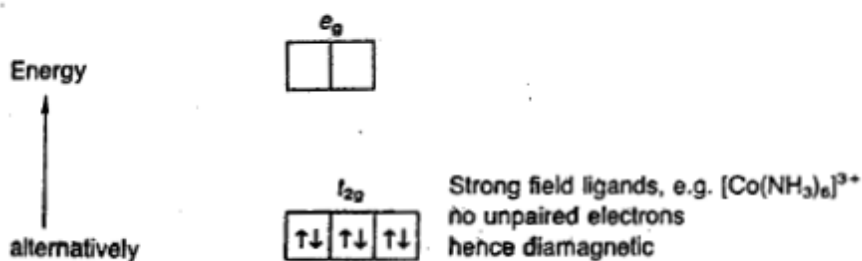

Co³⁺ octahedral complex with weak field ligands

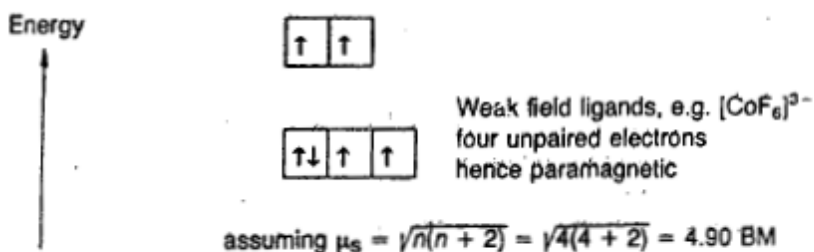

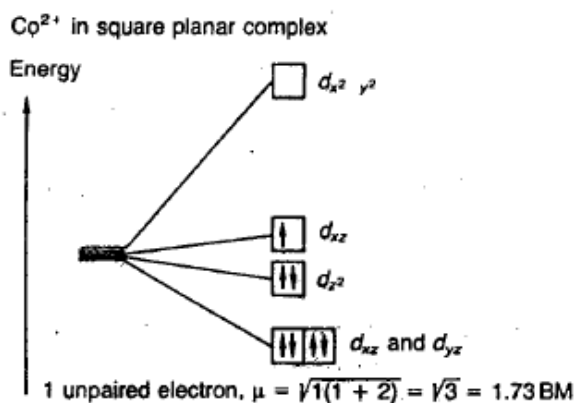
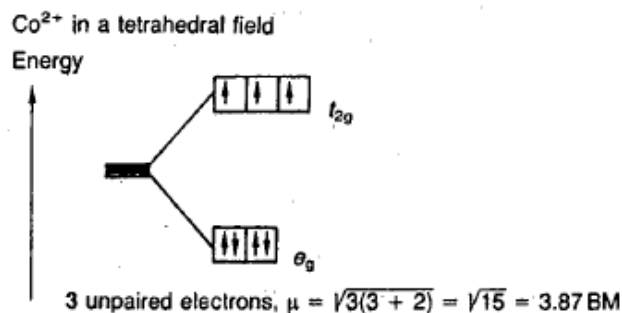

Special case of Copper acetate monohydrate, Cu(CH₃COO)₂·2H₂O

Copper (II) acetate monohydrate exists as a dimer and its structure is shown in fig. 6. The magnetic moment of the compound is only 1.43 BM which is less than the normal value of 1.75 – 2.2 BM for one unpaired electron. This suggests some weak coupling of spins of unpaired electrons on the two copper atoms in the dimeric structure. In its structure, the acetate groups act as bidentate bridging groups between the two copper atoms. Therefore, each copper atom is surrounded by four oxygen atoms in a square planar arrangement. The fifth position around each Cu atom is occupied by the oxygen atom from a water molecule. The other copper atom occupies the sixth of the octahedral positions.

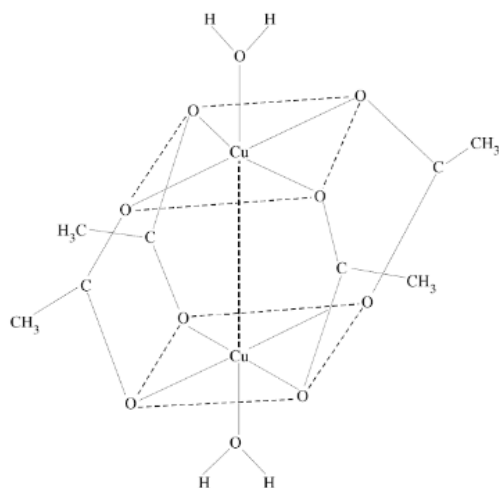

Figure 6. Structure of dimeric Cu (II) acetate monohydrate.

Electronic Spectra of Transition Metal Complexes

For example: If red is absorbed, the complex appears green.



Colour of light absorbed	Approx. λ ranges / nm	Colour of light transmitted
Red	700-620	Green
Orange	620-580	Blue
Yellow	580-560	Violet
Green	560-490	Red
Blue	490-430	Orange
Violet	430-380	Yellow

The variety of colors among transition metal complexes has long fascinated the observer. For example, aqueous solutions of octahedral $[\text{Co}(\text{H}_2\text{O})_6]^{2+}$ are pink but those of tetrahedral $[\text{CoCl}_4]^{2-}$ are blue. The green color of aqueous $[\text{Ni}(\text{H}_2\text{O})_6]^{2+}$ turns blue when ammonia is added to the solution to give $[\text{Ni}(\text{NH}_3)_6]^{2+}$. The reduction of violet $[\text{Cr}(\text{H}_2\text{O})_6]^{3+}$ gives bright blue $[\text{Cr}(\text{H}_2\text{O})_6]^{2+}$. As with all colors, these arise from electronic transitions between levels whose spacings correspond to the wavelengths available in visible light. (Of course, when a photon of visible light is absorbed, it is its complementary color that we actually see.) In complexes, these transitions are frequently referred to as *d-d* transitions because they involve the molecular orbitals that are mainly metal *d* in character (the e_g and t_{2g} or e and t_2 orbitals in octahedral and tetrahedral complexes, respectively). Obviously, the colors produced are intimately related to the magnitude of the spacing between these levels. Since this spacing depends on factors such as the geometry of the complex, the nature of the ligands present, and the oxidation state of the central metal atom, electronic spectra of complexes can provide valuable information related to bonding and structure.

The variation in the color of the Cr(III) complexes can be explained following similar argument.

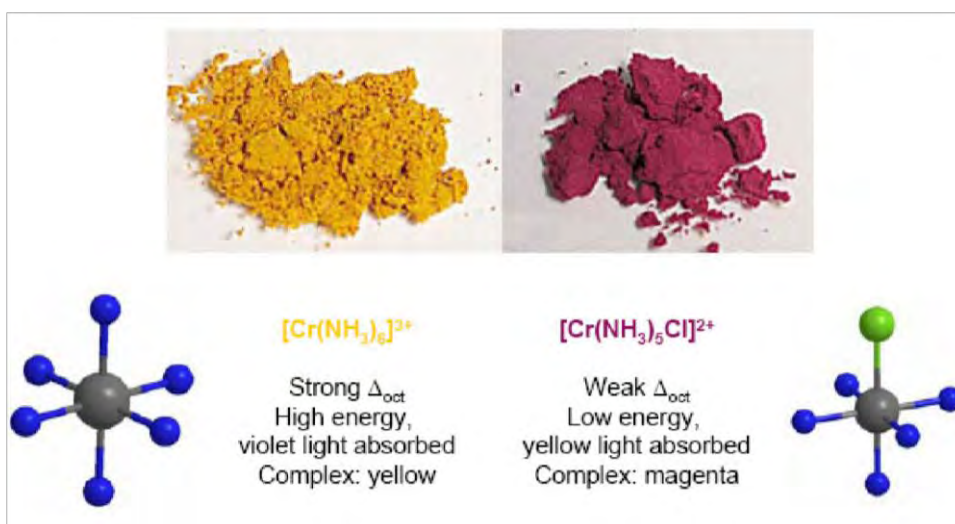
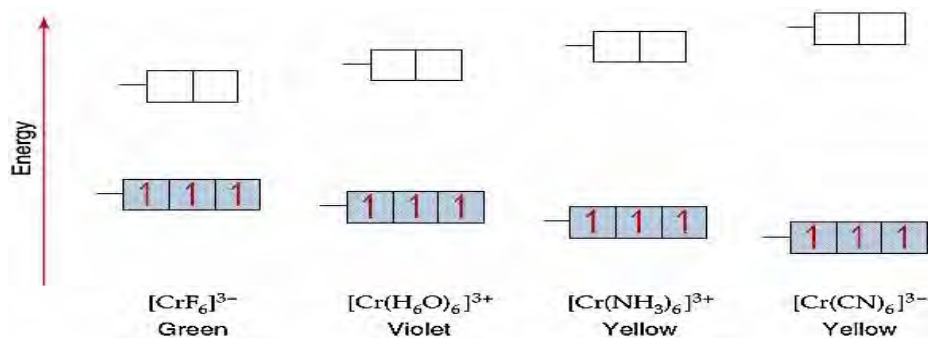

We observe the appearance of a shoulder in the case of $[\text{Ti}(\text{H}_2\text{O})_6]^{3+}$. Perfectly octahedral $[\text{Ti}(\text{H}_2\text{O})_6]^{3+}$ should give only one d-d Transition. However, distortion occurs to eliminate the degeneracy of the system. If a complex distorts from regular octahedral geometry, the t_{2g} and e_g levels are split, the consequence of which is the appearance of a shoulder as shown in the figure right.

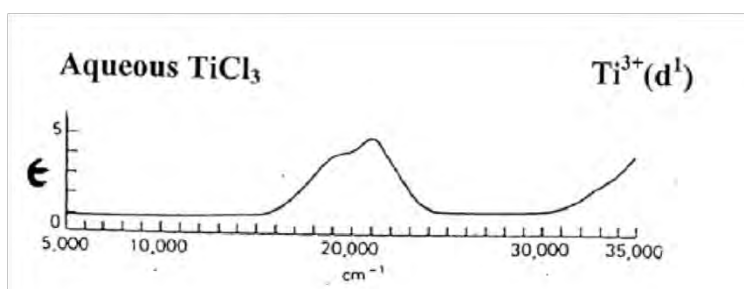

Complexes that contain metal ions of d^{10} electron configuration are usually colorless. Examples are $[\text{Cu}(\text{PPh}_3)_4]^+$ and $[\text{Zn}(\text{H}_2\text{O})_6]^{2+}$. One would expect a metal complex with no d-electron to be colorless as well. However, a few of such complexes are strongly colored, for example, MnO_4^- or $[\text{Cr}_2\text{O}_7]^{2-}$. The origin of the color in these complexes is not the d-d transitions, rather due to ‘charge transfer’ that we will briefly discuss later.

Multi-electron systems exhibit multiple transitions and the assignment of absorption bands is not straightforward. The complexity arises due to interelectron repulsions that we will not discuss in this course but will take a simpler approach to understand the color of coordination complexes.

Selection rules for electronic transitions

The Beer-Lambert Law

$$A = \log_{10}(I_0/I) = \epsilon cl$$

where ϵ is the molar extinction coefficient (in $\text{L cm}^{-1} \text{mole}^{-1}$), c is concentration in mole L^{-1} and l is the path length in cm. A is known as ‘Absorbance’ and it is dimensionless.

To explain the absorption spectra of coordination complexes, it is necessary to know the selection rules that govern electronic transitions. Any transition in violation of selection rule is said to be ‘forbidden’, but we will see how some rules are ‘more forbidden than others’. We shall not pursue the theoretical basis of the rules but merely outline simple tests for their application.

The Laporte Rule. In a molecule or ion possessing a centre of symmetry, transitions are not allowed between orbitals of the same parity, for example d to d . In other words, there must be change in parity ($\Delta l = \pm 1$), i.e. the orbital quantum number should differ by 1. The forbidden transitions are $s \rightarrow s$, $d \rightarrow d$, $p \rightarrow f$. etc. The geometries affected by this rule include octahedral and square-planar complexes. The rule is not applicable to tetrahedral complexes as it does not contain a center of symmetry.

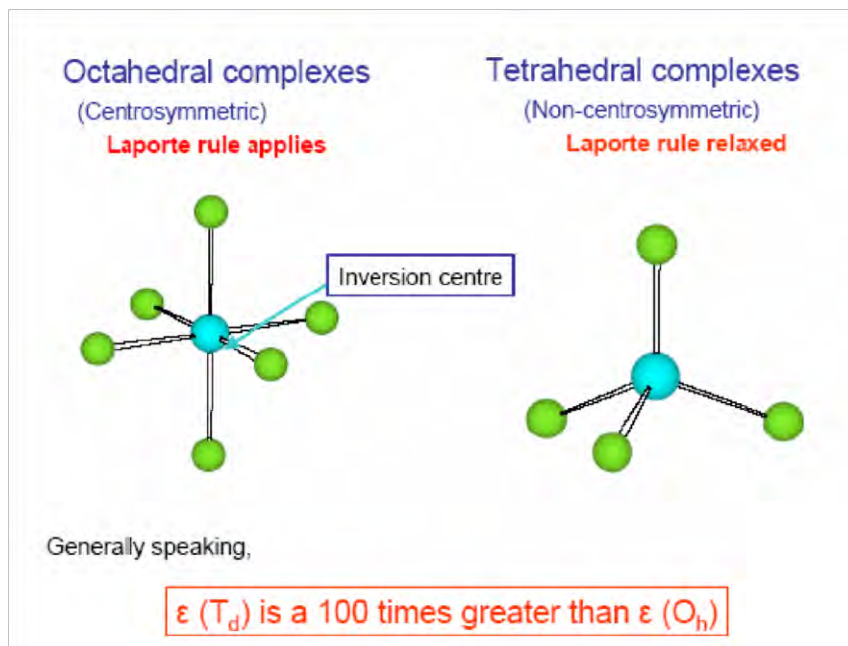

The key element here is that there are mechanisms by which selection rules can be relaxed so that transitions can occur, even if only at low intensities. Unsymmetrical vibrations of an octahedral complex can transiently destroy its center of symmetry and allow transitions that would otherwise be Laporte forbidden. In cases where the rule applies, the colors of the complexes are usually relatively pale. As examples, consider $[\text{Cu}(\text{H}_2\text{O})_6]^{2+}$ which is a rather pale blue color vs $[\text{Cu}(\text{NH}_3)_4]^{2+}$ which is an intense dark blue.

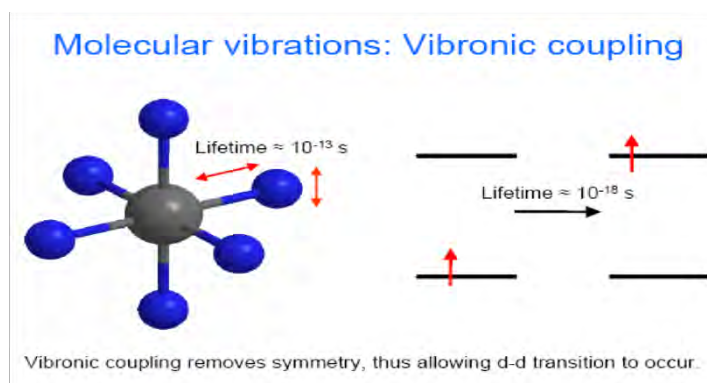

Spin Allowed - Spin Forbidden Any transition for which $\Delta S \neq 0$ is *strongly* forbidden; that is, in order to be allowed, a transition must involve no change in spin state. Consider the case of the high spin d^5 complex $[\text{Mn}(\text{H}_2\text{O})_6]^{2+}$. Electronic transition is not only Laporte forbidden but also spin forbidden. Absorptions that are doubly forbidden transitions are extremely weak. It is understandable, then, that dilute solutions of Mn(II) are colorless.

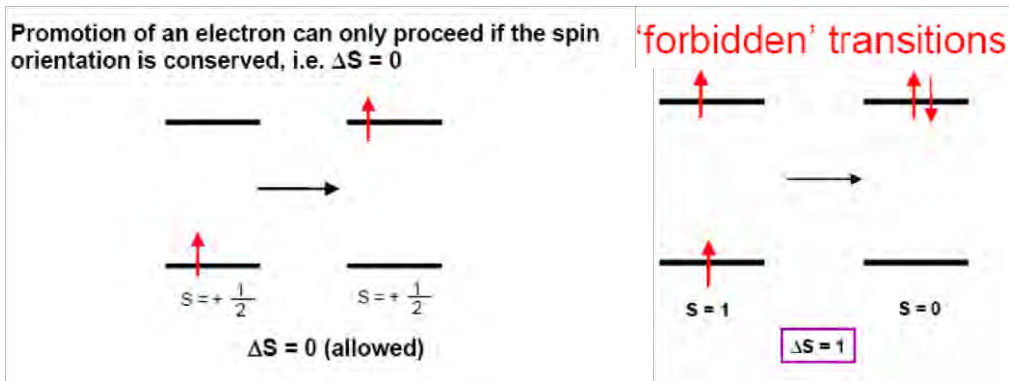

Charge-Transfer (CT) Bands. Similar to d-d transitions, charge-transfer (CT) transitions also involve the metal d-orbitals. CT bands are observed if the energies of empty and filled ligand- and metal-centered orbitals are similar. The direction of the electron transfer is determined by the relative energy levels of these orbitals: i) Ligand-to-Metal charge transfer (LMCT) like in MnO_4^- , CrO_4^{2-} etc. For MnO_4^- , the d-electron count on Mn(VII) is d^0 . The origin of the color in this species is not due to d-d transition, rather, charge transfer from O^{2-} to Mn(VII), described as LMCT band. ii) Metal-to Ligand charge transfer (MLCT) like in $[\text{Fe}(\text{bpy})_3]^{2+}$. In this complex the charge transfer occurs from Fe(II) to the empty π^* orbitals of bpy ligand.

CH 101R1

Module II: Organic Structure and Reactivity

Aromaticity, Geometrical isomerism: cis–trans, E/Z, and syn-anti isomerism; Optical isomerism & Chirality; Wedge, Fischer, Newmann and Sawhorse projection formulae and interconversions; D/L, R/S nomenclature system; Conformational studies of n-butane.

Addition, Elimination, Substitution and Rearrangement reaction.

CONJUGATED MOLECULES

Resonance Effect

If two double bonds in a molecule are separated by a single bond, they are said to be in conjugation and the molecule having such bonds are called conjugated molecules e.g., 1, 3-butadiene.

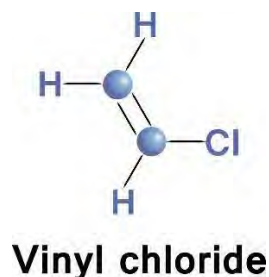
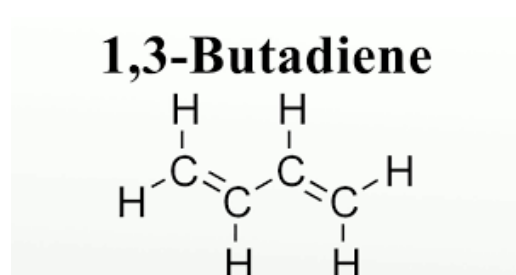

Another example of conjugation is given by benzene which is a hexagonal ring of carbon atoms with three double bonds in alternate positions. Alternatively, a double bond or a triple bond may also be in conjugation with a lone electron pair e.g., in vinyl chloride. Conjugated molecules do not exhibit the character of pure double bond or triple bond, for example, benzene is expected to be highly reactive since it has three double bonds in the ring but is actually quite stable. In order to explain the difference in the expected and the actual behaviour of the conjugated molecules, Robinson and Ingold stated that such compounds exist in two or more forms none of which can explain all the properties of the molecule under investigation. They called this concept as mesomerism or mesomeric effect. Heisenberg studied the same mathematically.

and named it as resonance or resonance effect. According to the concept, If a compound having a certain molecular formula can be represented by different structural formulae which differ only in the arrangement of the electron pairs and not of the atoms, such like structures are called resonating or contributing or canonical structures and the phenomenon is known as resonance. The compound cannot be represented completely by any of the resonating or contributing structures but by a mixture of all of them which is called resonance hybrid (cannot be actually represented). Resonance is indicated by the sign \longleftrightarrow .

It may be noted that the various resonating or contributing structures do not actually exist i. e., they are all hypothetical structures. They have been given simply to explain certain properties of the compounds which cannot be otherwise explained

Examples of Resonance

A common analogy of a resonance hybrid is that of a mule which is a hybrid of horse and donkey.

1. **Monocarboxylic acid.** The acidic character of monocarboxylic acid is explained with the help of resonance. The following contributing structures for the monocarboxylic acid are possible which differ in the position of the electron pairs.

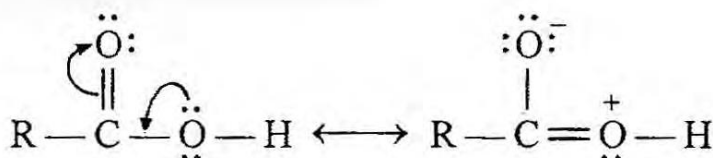

As a result of resonance, the oxygen atom of the O — H group acquires a positive charge i. e., it draws the electrons pair towards itself resulting in the release of protons.

2. **Benzene.** Benzene is a hybrid of two equivalent contributing structures (I and II) which differ in the position of the pi -electron pairs representing double bonds. These were suggested by Kekule.



Three more contributing structures (III, IV and V) have been proposed by Dewar. Being less symmetrical they have small contribution towards the hybrid.

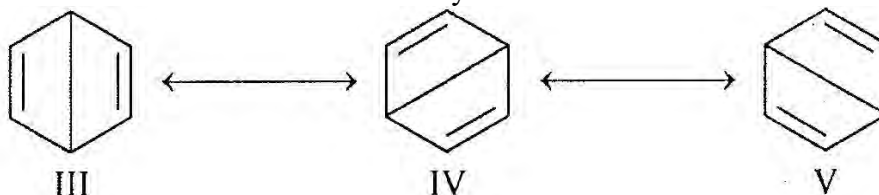

Benzene exists mainly in the form of Kekule structures (I and II). Benzene is, in fact, quite stable and its stability is explained with the help of resonance. As the pi-electron charge is distributed over greater area i. e., it gets delocalised.

3. **1, 3 - Butadiene.** The diene can be regarded as the hybrid of the following contributing structures:

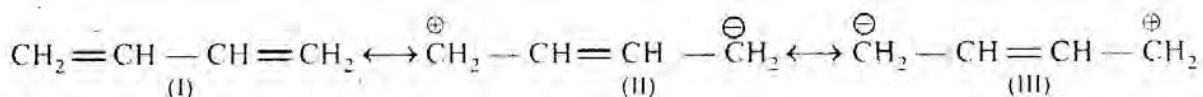

The charged structures II and III make lesser contribution towards the hybrid. However, they do explain the 1, 4-addition in the conjugated dienes.

4. Carbon dioxide. The structural formula of carbon dioxide (CO₂) molecule is O = C = O.

The standard C = O bond length is 122 pm but the bond length which is obtained for the molecule from spectroscopic studies is 115 pm. The difference in the bond length values can be explained by considering the following structures for carbon dioxide which are known as the resonating structures or contributing structures or canonical structures.

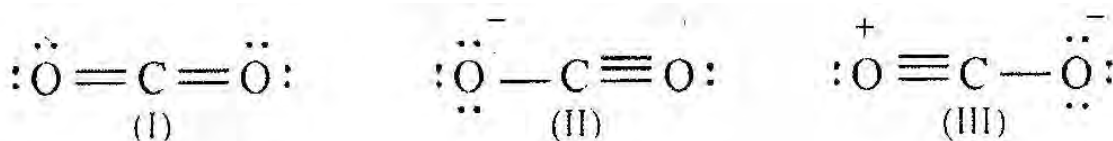

The carbon-oxygen bond length is the mean of all the bond length values. Carbon dioxide cannot be represented by any of the contributing structures but by an average of all. Carbon dioxide is said to be a resonance hybrid of these structures.

Conditions of resonance:

Wheland has suggested the following conditions for resonance:

- (i) The resonance or the contributing structures must differ only in the position of the electron pairs and not of the atomic nuclei.
- (ii) The resonating structures must have the same number of paired and unpaired electrons.
- (m) The energies of the various resonating structures must be either same or nearly the same.
- (iv) All the contributing or resonating structures do not contribute equally towards the hybrid. The equivalent structures have greater contribution. The contribution of any resonating structure towards the hybrid depends upon the following factors:

- (a) Structures with more covalent bonds are more stable than the structures with less covalent bonds.
- (b) The charged contributing structure is less stable as compared to the structure without any charge.
- (c) Structure with negative charge on more electronegative atom is more stable structure with negative charge on less electronegative atom.

Effects of resonance

Some effects of the resonance are explained as under:

1. **Stability.** As a result of resonance, the energy of the hybrid decreases and its stability therefore increases. Greater the number of contributing structures; greater will be the stability of the hybrid. The stability also depends upon the equivalence of the contributing structures. Moreover, the charged structures have less contribution than the uncharged structures. **Resonance energy:** The relative stabilities of two different resonance hybrids may be compared in terms of resonance energy. It may be defined as the difference in the energy content of the hybrid and its most stable contributing structure.

2. **Bond length.** The resonance causes a change in bond length values. For example, the standard C — C bond length is 154 pm and C = C bond length is 134 pm. But the value as

determined for benzene is 139 pm, which does not coincide with any of the two values and is intermediate between the two values.

Huckel's molecular orbital theory of conjugated systems

The German chemist Erich Hückel was the first to recognize that an aromatic compound must have an odd number of pairs of pi electrons. In 1931, he described this requirement by what has come to be known as **Hückel's rule**, or the **(4n + 2) rule**. According to this rule, monocyclic planar systems of trigonally hybridised atoms which contain (4n + 2) pi electrons possess considerable stability and hence, aromatic character where 'n' may vary from 0, 1, 2, 3, 4...etc. Thus, cyclic compounds having 2, 6, 10, 14, 18 or 22 pi electrons are expected to show aromatic character. But 'n' does not denote the number of rings in the cyclic compound.

Aromatic character of some cyclic systems:

(1) Monocyclic systems. All the monocyclic compounds shown below have a number of pi electrons in the ring according to the Huckel's rule. i.e., all of them have six pi-electrons in the ring. They are, therefore, aromatic.

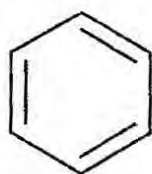

Benzene

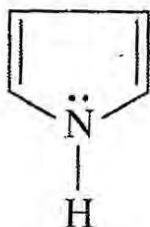

Pyrrole

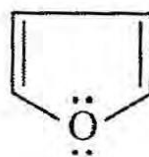

Furan

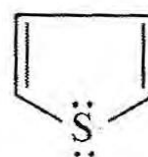

Thiophene

In the heterocyclic compounds pyrrole, furan and thiophene, four pi electrons are contributed by the two double bonds in the ring while two electrons are contributed by the hetero atom. It may be noted that cyclooctatetraene does not show any aromatic character although the ring has four, double bonds in the alternate positions. This is because it does not follow Huckel's rule.

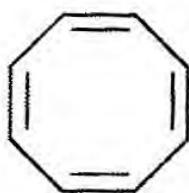

cyclooctatetraene

The number of pi-electrons (8) is not according to Huckel's rule.

(ii) Fused ring systems. The polynuclear hydrocarbons such as naphthalene, anthracene and phenanthrene are aromatic in nature according to Huckel's rule (6 and 14 pi electrons).

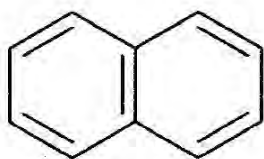

Naphthalene
(10 π -Electrons)

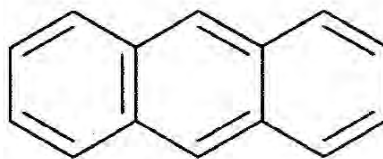

Anthracene
(14 π -Electrons)

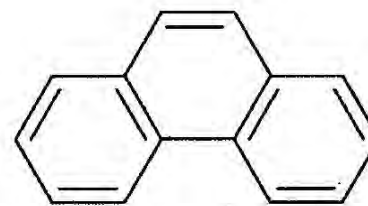

Phenanthrene
(14 π -Electrons)

(iii) Aromatic ions system. It may be noted that not only the molecules but even some cyclic ions exhibit aromatic character. A few such ions are listed:

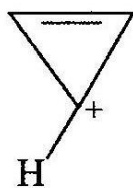

Cyclopropene
cation
(2 π -Electrons)

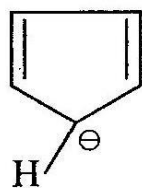

Cyclopentadiene
anion
(6 π -Electrons)

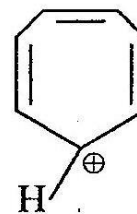

Cycloheptatriene
cation
(6 π -Electrons)

ISOMERISM

One of the striking features of organic compounds is that they exhibit isomerism. Compounds having the same molecular formula and molecular mass but having different characteristics are called isomers. This phenomenon is called isomerism. The relative position of different atoms or groups in these isomers is different and that causes the difference in properties. Isomerism may be classified into two types:

1. Structural isomerism. In this type of isomerism, the molecules differ in the structural arrangement of the atoms or groups.
2. Stereoisomerism. Here the isomers possess the same structural arrangement but differ with respect to the arrangement of atoms or groups in space.

1. STRUCTURAL ISOMERISM

If two or more compounds differ in the relative arrangement of atoms in the molecule, they are said to be structural isomers and this phenomenon is known as structural isomerism. There are different kinds of structural isomerisms as under:

- (i) Chain isomerism or Nuclear isomerism.
- (ii) Position isomerism.
- (iii) Functional isomerism.
- (iv) Metamerism.
- (v) Tautomerism

Each one of these is discussed as under.

- (i) Chain Isomerism or Nuclear Isomerism

If different compounds of the same class of organic compounds, having the same molecular formula, differ in the structure of carbon chain, they are called chain isomers. Examples of this type of isomerism are:

(a) n-Butane and Isobutane (Mol Formula = C_4H_{10})



(b) n-Pentane, isopentane and neo pentane (Mol Formula: C_5H_{12})

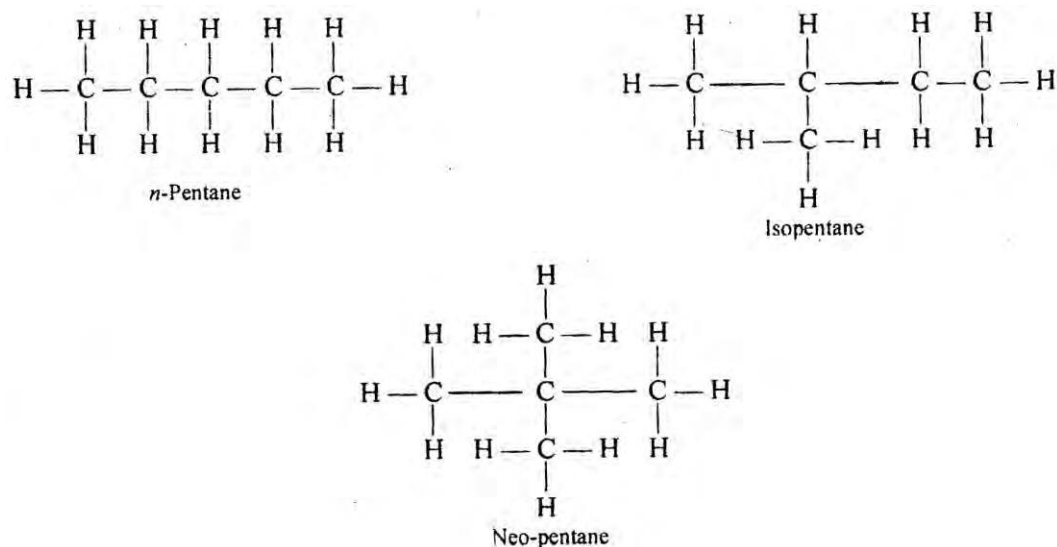

(ii) Position Isomerism

If different compounds, belonging to some homologous series, with same molecular formula have same carbon skeleton but differ in the position of substituent or functional group; these are known as position isomers. Examples of this type of isomers are:

(a) 1-Propanol and 2-propanol (Mol. Formula = C_3H_8O)

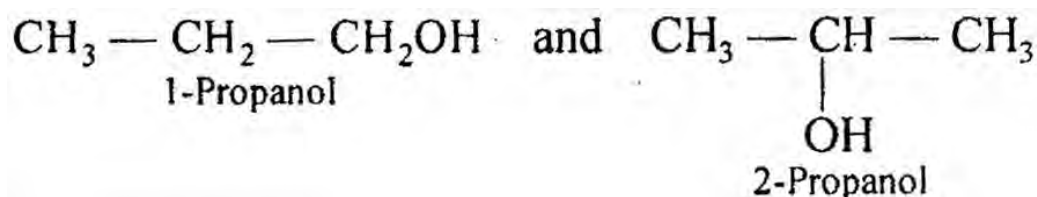

(b) 1-Butene and 2-Butene (Mol. Formula = C₄H₈)

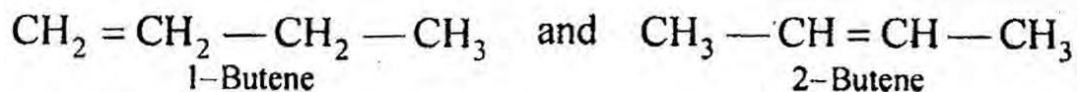

(iii) Functional isomerism

Different compounds, with same molecular formula but different functional groups are known as functional isomers. For example:

(a) Ethyl alcohol and Di methyl ether (Mol. Formula = C₂H₆O)

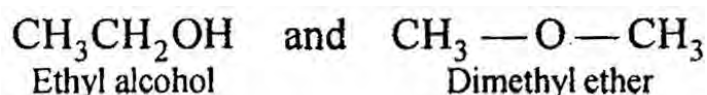

(b) Propanaldehyde and acetone (Mol. Formula = C₃H₆O)

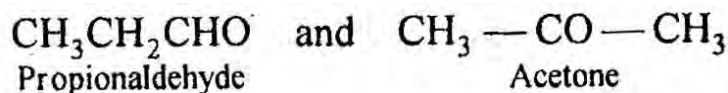

(iv) Metamerism:

This is a special kind of structural isomerism in which different compounds, with same molecular formula, belong to same homologous series but differ in "the distribution of alkyl groups around a central atom.

Examples are:

(a) Diethyl ether and methyl propyl ether (Mol. Formula = C₄H₁₀O)

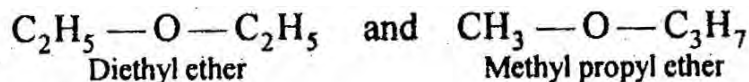

(b) Diethyl ketone and methyl propyl ketone (Mol. Formula = C₅H₁₀O)

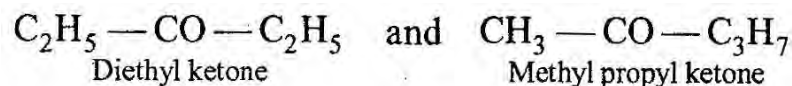

(v) Tautomerism :

Compounds whose structures differ in the arrangement of atoms but which exist simultaneously in dynamic equilibrium with each other are called tautomers. This phenomenon is called tautomerism. In most of the cases tautomerism is due to shifting of a hydrogen atom from one carbon (or oxygen or nitrogen) to another with the rearrangement of single or double bonds. For example,

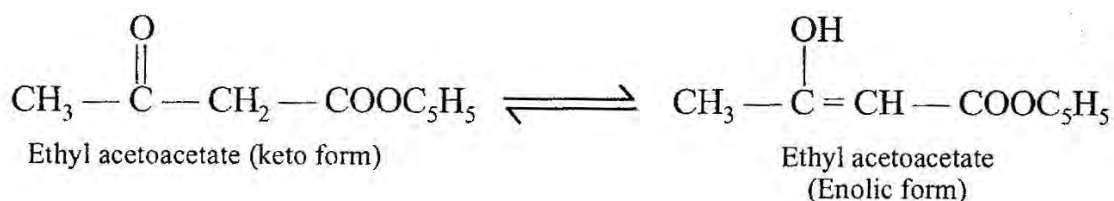

2. STEREOISOMERISM

Compounds having different three-dimensional relative arrangement of atoms in space are called stereoisomers. This phenomenon is called stereoisomerism. These compounds are said to have different configurations. Stereoisomerism is of the following different kinds:

- (i) Geometrical isomerism.
- (ii) Optical isomerism
- (iii) Conformational isomerism

(i) Geometrical isomerism

Two carbon atoms joined by a single bond (sigma bond) are capable of free rotation around each other, but this rotation is hindered in case of compounds containing carbon-carbon double bond. According to molecular orbital theory, carbon atoms involved in double bond formation are sp^2 hybridised so that each carbon atom has three planar Sp^2 hybridised orbitals and fourth p orbital having its lobes at right angles to the plane of sp^2 orbitals. The formation of pi bond involves the overlapping of p orbitals. With the formation of a pi bond between C — C along with the sigma bond, which is already existing, there remains no possibility of rotation along C — C axis. Neither of the two doubly bonded carbon atoms can be rotated about double bond without destroying the pi bond, which requires large amount of energy. Thus, at ordinary temperature, the rotation about a carbon - carbon double bond is restricted or hindered and gives rise to a kind of stereoisomerism known as 'Geometrical isomerism'.

Geometrical Isomerism, also known as cis-trans isomerism takes place in compounds containing carbon-carbon double bond in which each of the two doubly bonded carbon atoms is attached to two different atoms or groups. All the compound with general formula of the type $C_{AB} = C_{DE}$ or $C_{AB} = C_{AB}$ show geometric isomerism. If either of the two carbon atoms carries two identical/groups as in $C_{AB} = C_{AA}$ or $C_{AB} = C_{DD}$, the isomerism does not exist. This isomerism is due to difference in the relative spatial arrangement of the atoms or groups about the doubly bonded carbon atoms.

Conditions to be fulfilled by a compound to exhibit geometrical isomerism

For a compound to show geometrical isomerism the following conditions are necessary:

- (i) The molecule must contain a carbon-carbon double bond about which there is no free rotation.
- (ii) Each of the double bonded carbon atoms must be attached to two different atoms or groups.

In case of compounds with formula of the type $C_{AB} = C_{AB}$; if two similar groups are on the same side of double bond, the isomer is known a **cis-** and if two similar groups are on the opposite sides of the double bond the isomer is known as **trans** such as:

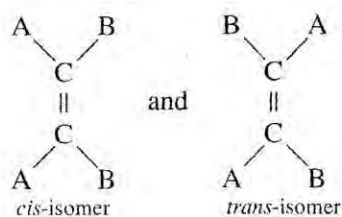

For example,-

2-butene exists in two isomeric forms.

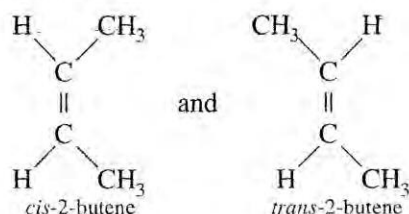

Similarly butene-dioic acid exists in two isomeric forms; *cis*- form is called maleic acid and *trans*- form is called fumaric acid

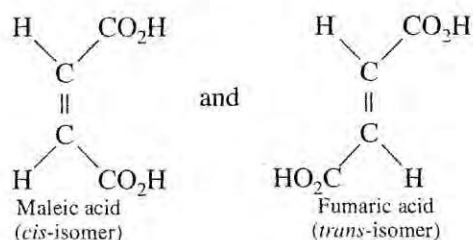

Determination of configuration of a geometrical isomer

Different methods available for determination of configuration of a geometrical isomers are described below;

(i) From Dipole moments. Generally *cis*-isomer has greater dipole moment as compared to *trans*-isomer. In case of *cis*- the similar groups being on the same side, the electronic effects are additive; while in case of *trans*-isomer, the similar groups being on opposite side, the electronic effects cancel each other.

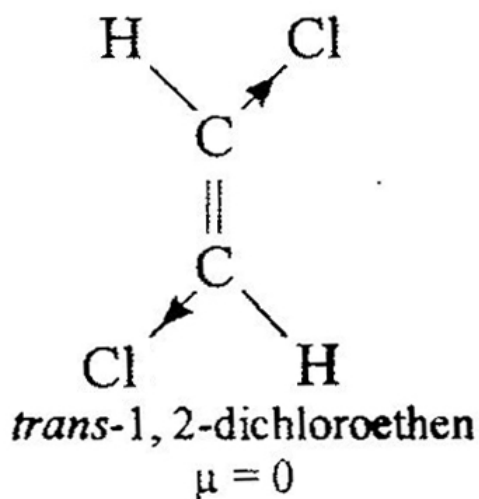
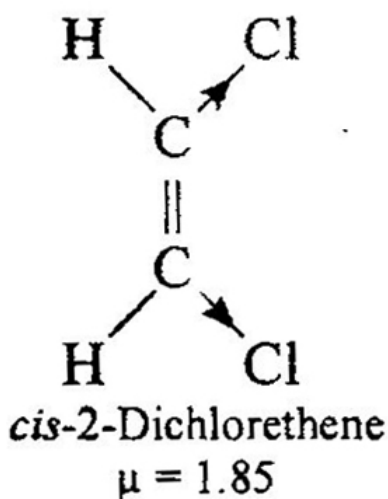
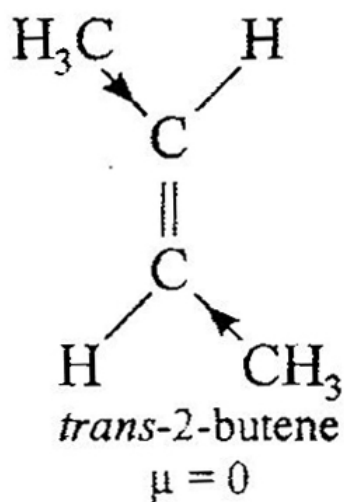
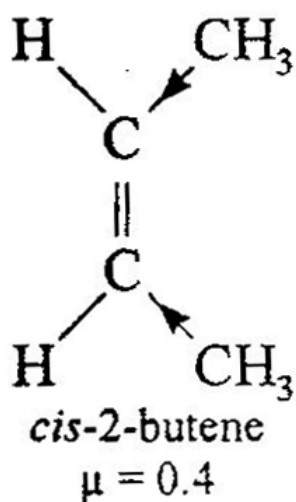

- (ii) From boiling point. Generally speaking, a *cis* isomer has a higher boiling point compared to the *trans* isomer. This is because of higher dipole moment and higher polarity in the molecule which acts as the binding force and is responsible for higher b.p. of the *cis* isomer. Boiling point of *cis*-2-butene is 277 K while the *trans*-2-butene boils at 274 K.

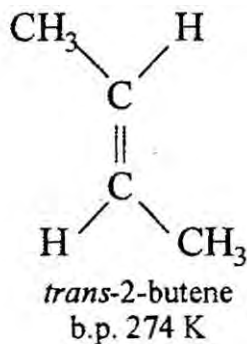
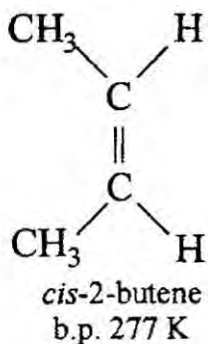

- (iii) From melting point. The isomers show a reverse trend here. The 'U' shape of the *cis* isomer doesn't pack well compared to the straighter *trans* isomer. The poorer packing of the *cis* isomer means that the intermolecular forces are not as effective as they should be

and so less energy is required to melt the cis isomers. Thus, maleic acid melts at 403 K whereas fumaric acid melts at 575 K.

- (iv) From the formation of cyclic compounds. Two geometric isomers (cis and trans) can be distinguished through reactions that lead to formation of ring. Cis-isomer undergoes ring closure more readily than the trans-isomer. For example maleic acid readily loses water when heated to about 423 K, to give an anhydride; while fumaric acid does not give anhydride at this temperature. Rather it must be heated to 573 K to get the same anhydride. Further, hydrolysis of anhydride yields only maleic acid.

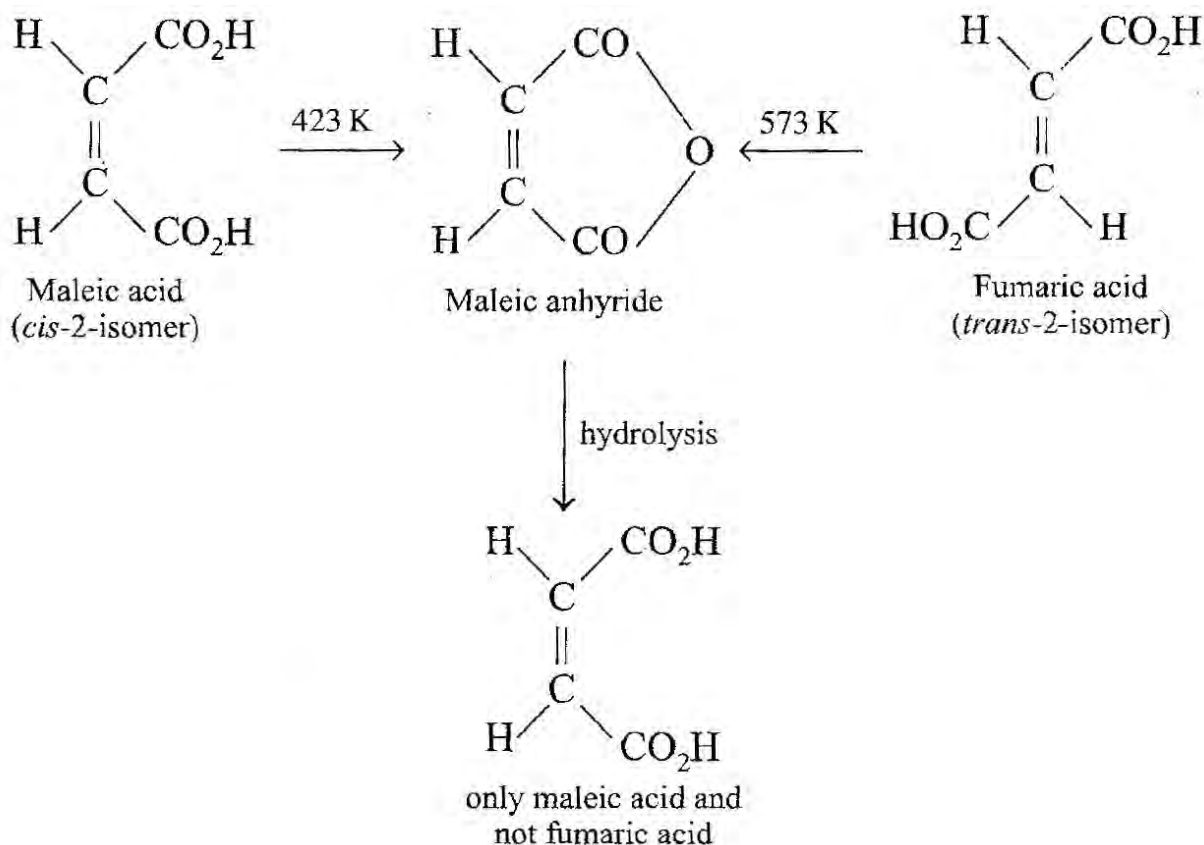

- (v) From the formation of the type of optical isomer. Maleic acid and fumaric acid, both on treatment with KMnO₄ or OSO₄ yield optically inactive variety of tartaric acid. Maleic acid yields meso tartaric acid, while fumaric acid yields racemic (\pm or dl) tartaric acid.

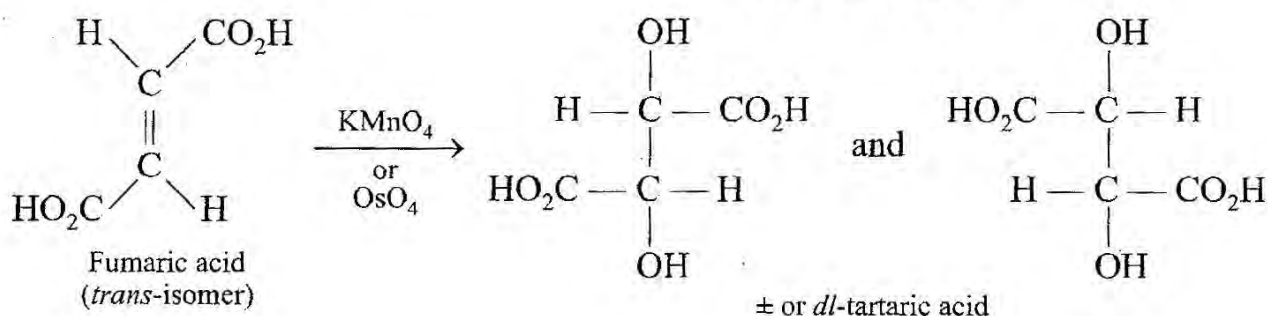
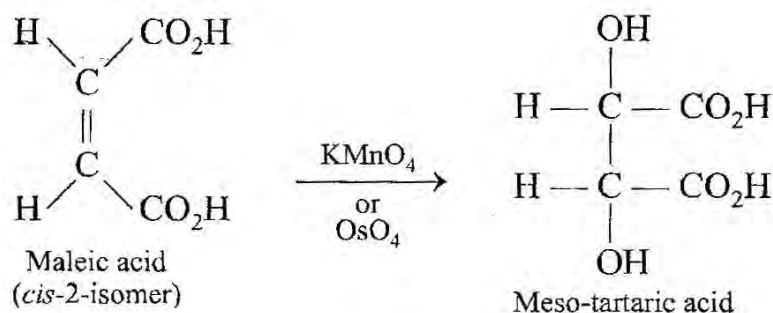

- (vi) From the method of preparation. Method of preparation of a compound sometimes leads to its configuration. The isomer obtained by the rupture of a ring must be the *cis*-isomer, e.g., maleic acid can be prepared by the oxidation of benzene or quinone, so it must be a *cis*-isomer.

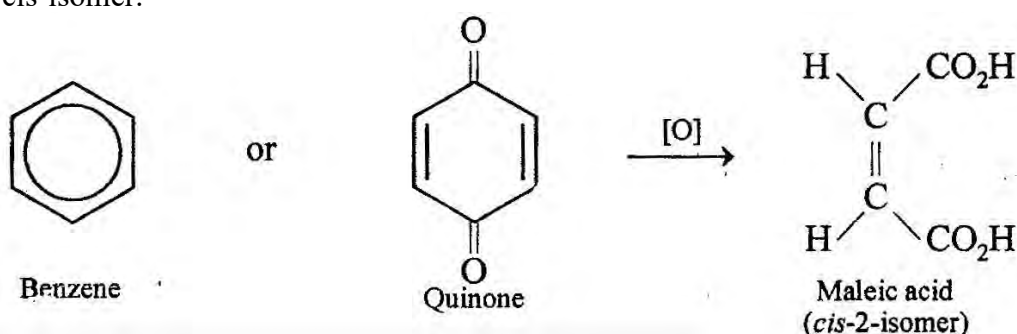

E and Z designations of geometrical isomers

The *cis* and *trans*- designations can be used only for the compounds in which two doubly bonded carbon atoms are having similar atoms or groups e. g., of the type $\text{C}_{\text{AB}} = \text{C}_{\text{AB}}$. But, when the two doubly bonded carbon atoms are having different atoms or groups attached to them e.g., of the type $\text{C}_{\text{AB}} = \text{C}_{\text{DE}}$; it is not possible to assign them *cis* or *trans* configurations. To overcome this difficulty, a more general system for designating the configuration of geometric isomers has been adopted. This system developed by Cahn, Ingold and Prelog originally for the absolute configuration of optical isomers, is known as E and Z system and is based on priority of attached groups. The atoms or groups attached to each carbon of the double bond, are assigned first and second priority. If the atoms or groups having higher priority attached to two carbons are on the same side of double bond the configuration is designated as Z (derived from German word Zusammen meaning together)

and if the atoms or groups of higher priority are on the opposite side of the double bond, the configuration is designated as E (derived from German word -entgegen meaning across or opposite). Priorities of atoms or groups are determined in the same way as for R & S configurations of optical isomers. At. weights or atomic numbers of atoms directly linked with ethylenic carbon atoms are taken into consideration.

Let us consider an example in which two doubly bonded atoms are attached to four different halogens such as $C_{BrF} = C_{ClI}$. Since Br is having higher priority over F and I is having priority over Cl (due to their higher atomic numbers). The isomer in which Br and I are on the same side of double bond will be called Z and the isomer in which Br and I are on the opposite sides of double bond will be called E.

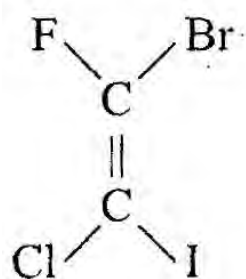

Z-isomer

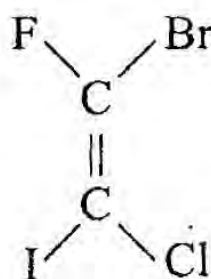

E-isomer

In the same way cis and trans isomers of 2-butene can be called Z and E-2-butenes respectively.

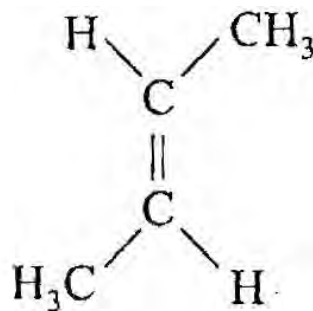
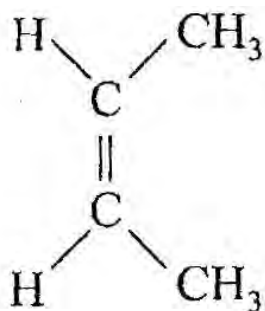

Similarly maleic acid can be specified as Z-isomer and fumaric acid as E-isomer.

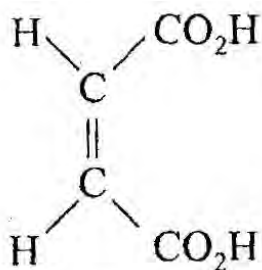

Maleic acid
(Z-isomer)

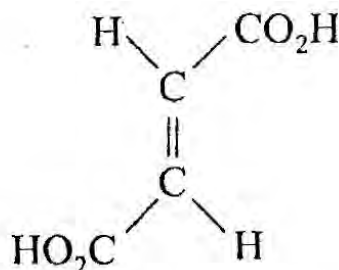

Fumaric acid
(E-isomer)

In determining the configuration, we have to select the group of higher priority on one carbon. Similarly we select the group of higher priority on the other carbon atom. If these two groups are on the same side of double bond, the configuration is Z, otherwise it is E.

Syn anti Isomerism

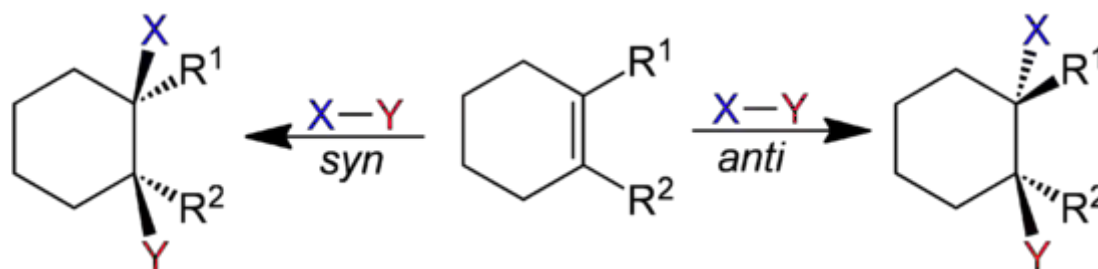

Syn addition is the addition of two substituents to the same side (or *face*) of a double bond or triple bond, resulting in a decrease in bond order but an increase in number of substituents. Generally, the substrate will be an alkene or alkyne. An example of syn addition would be the oxidation of an alkene to a diol via a suitable oxidizing agent such as Osmium tetroxide OsO₄ or Potassium permanganate KMnO₄.

Anti addition is in direct contrast to syn addition. In anti addition, two substituents are added to opposite sides (or faces) of a double bond or triple bond, once again resulting in a decrease in bond order and increase in number of substituents. The classical example of this is bromination (any halogenation) of alkenes.

Depending on the substrate double bond, addition can have different effects on the molecule. After addition to a straight-chain alkene such as C₂H₄, the resulting alkane will rapidly and freely rotate around its single sigma bond under normal conditions (i.e. room temperature). Thus whether substituents are added to the same side (syn) or opposite sides (anti) of a double bond can usually be ignored due to free rotation. However, if chirality or the specific absolute orientation of the substituents needs to be taken into account, knowing the type of addition is significant. Unlike straight-chain alkenes, cycloalkene syn addition allows stable addition of substituents to the same side of the ring, where they remain together. The cyclic locked ring structure prevents free rotation.

(ii) Optical isomerism or enantiomerism

Before taking up optical isomerism, let us understand the terms: plane polarised light, optical activity and specific rotation.

Plane polarised light:

Ordinary light has vibrations taking place at right angles to the direction of propagation of light spread in all the possible planes. If we pass ordinary light through nicol prism, vibrations in all planes except one are cut off. Thus light coming out of nicol prism has vibrations only in one plane. Such a light is called plane polarised light.

Optical activity

Behaviour of certain substances is strange. When a plane polarised light is passed through the solution of such substances, the light coming out of the solution is found to be in a different plane. The plane of polarised light is rotated. Such substances, which rotate the plane of plane polarised light when placed in its path are known as optically active substances and the phenomenon is known as optical activity. The angle of rotation (α) of plane polarised light is known as Optical rotation. The substances which rotate the plane of polarised light to the

clockwise or right direction are known as dextrorotatory or having positive (+) rotation and those which rotate the plane polarised light to the anticlockwise or left direction are known as laevorotatory or having negative (-) rotation. Substances which do not rotate the plane of polarised light are said to be optically inactive. The instrument used for measuring optical rotation is called polarimeter. It consists of a light source, two nicol prisms and in between a tube to hold the solution of organic substance. The schematic representation of a polarimeter is given below:

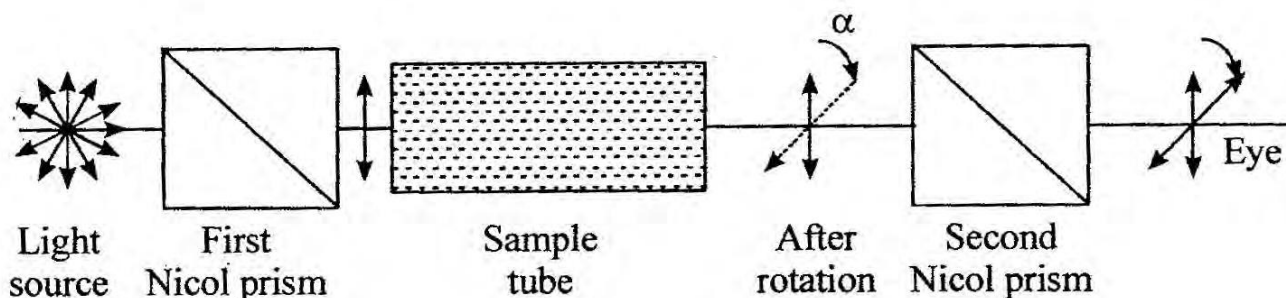

Specific rotation. The angle of rotation of plane-polarised light or optical rotation (α) of an organic substance depends not only on the kind of molecules but also varies considerably with the number of molecules that light encounters in its path which in turn depends on the concentration of the solution used and the length of polarimeter tube containing it. Besides this, it depends on temperature, wavelength of light and nature of solvent used.

The optical activity of a substance is expressed in terms of *specific rotation*, $[\alpha]_{\lambda}^t$ which is a constant quantity, characteristic of a particular substance,

$$[\alpha]_{\lambda}^t = \frac{\alpha}{l \times c}$$

where, α = observed rotation in degrees

λ = length of polarimeter tube in decimeter

c = concentration of substance in gm per ml of solution

t and λ signify the temperature and wavelength of light used.

When $l = 1$ and $c = 1$, $[\alpha]_{\lambda}^t = \alpha$

Specific rotation is thus defined as the optical rotation produced by a compound when plane polarised light passes through one decimeter length of the solution having concentration one gram per millilitre. Usually the monochromatic light used is D line of sodium ($\lambda = 589$ nm). Thus specific rotation of cane sugar can be expressed as

$$[\alpha]_{\text{D}}^{20^{\circ}\text{C}} = +66.5^{\circ} \text{ (water)}$$

In this expression D stands for D line of sodium, 20°C is temperature of measurement, + sign shows the dextrorotation and water is the solvent used.

Louis Pasteur, while studying the crystallography of salts of tartaric acid made a peculiar observation. He observed that optically inactive sodium ammonium tartarate existed as a mixture of two different types of crystals which were mirror images of each other. With the help of 'a' hand lens and a pair of forceps, he carefully separated the mixture into two different types of crystals. These crystals were mirror images of each other and were called enantiomorphs and the phenomenon as enantiomorphism. Although the original mixture was optically inactive;

each type of crystals when dissolved in water, were found to be optically active. Moreover the specific rotations of the two solutions were exactly equal but of opposite sign i.e. one solution rotated the plane polarised light to the right or clockwise while the other to the left or anticlockwise and to the same extent. Two types of crystals or solutions were identical in all other physical and chemical properties. Isomers which are non superimposable mirror images of each other are called enantiomers.

According to La Bell and Van't Hoff the four valencies of a carbon atom are directed towards the four corners of a regular tetrahedron at the centre of which lies the carbon atom. Consider a compound of formula C_{LMNO} having four different groups L, M, N and O - attached to a carbon atom. This compound can be represented by two models which look like mirror images of each other.

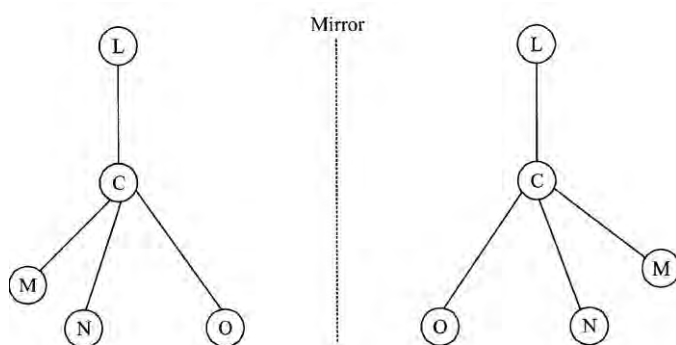

It is important to note here that these two molecules cannot be superimposed on each other i.e. they will not coincide in all their parts. We may turn them in as many ways as we like but we find that though two groups of each may coincide, the other two do not. Hence these must represent two isomers of formula C_{LMNO} . Lactic acid $CH_3CHOHCOOH$ and sec-Butyl chloride $C_2H_5CHClCH_3$ exist as two optically active isomers which are enantiomers i.e. mirror images of each other.

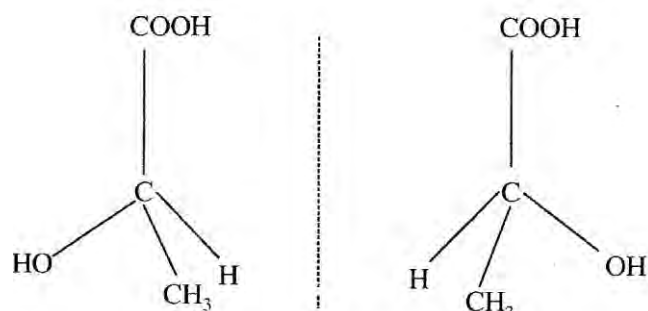

Enantiomers of Lactic Acid

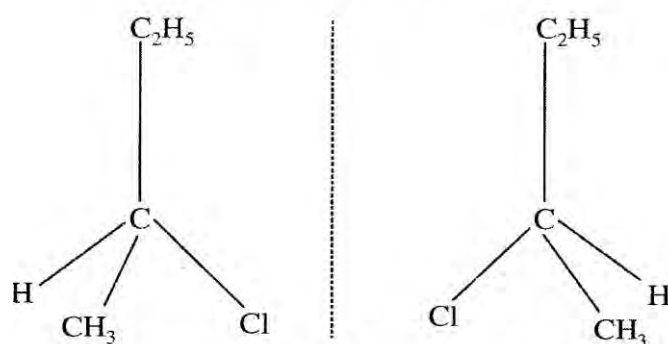

Enantiomers of Sec. Butyl Chloride

Mirror images of the two compounds are represented as above. The carbon atom to which four different groups are attached, is known as asymmetric or chiral carbon atom or stereogenic centre. If two of the groups attached to carbon are same, we shall observe that it is possible to superimpose the mirror images on each other. Such a compound will not show optical isomerism or enantiomerism.

Hence non-superimposability of the mirror images is responsible and essential for the type of stereoisomerism known as enantiomerism.

The term optical isomerism is used for the existence of stereoisomers which differ in their behaviour towards the plane polarised light. Thus enantiomeric molecules are always non-superimposable mirror images of each other. The non—superimposability of mirror images arises due to chiral or asymmetric nature of molecule. A molecule is said to be chiral if it has no plane of symmetry and is therefore non-superimposable on its mirror image.

It may be concluded with the remarks that chirality is the fundamental condition of enantiomerism or optical isomerism.

Chirality and dissymetry

An object which is non-superimposable on its mirror image is called chiral object. And an object which is superimposable on its mirror image is called achiral object. Examples of chiral objects including letters from English alphabets are: A pair of hands, shoes, gloves, letters P, F, J etc.

Examples of achiral objects and letters are: Ball, sphere, letters A, O, M, etc.

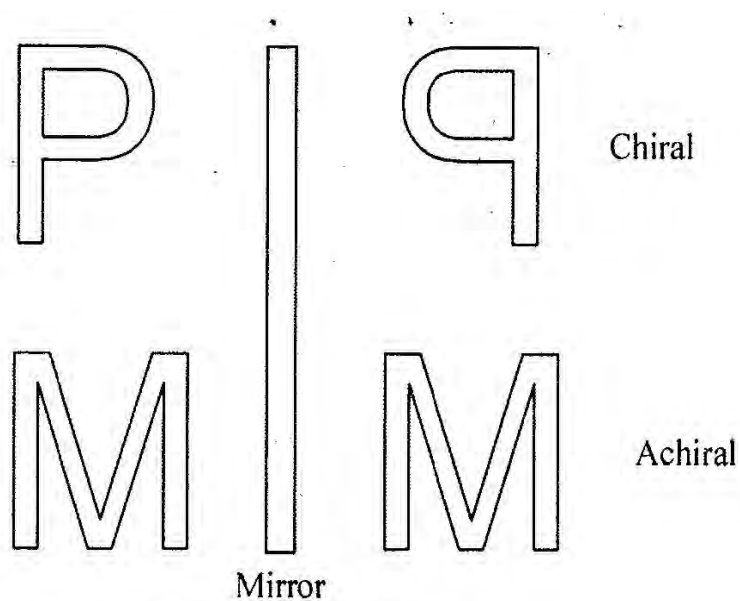

Chiral and achiral Objects

Achiral objects or molecules possess a plane of symmetry that can divide the molecule into two identical halves. Chiral objects or molecules do not possess a plane of symmetry that can divide the molecule into two identical halves. The chirality is also known as dissymmetry while achirality is also known as symmetry.

Thus chirality or dissymmetry is the property associated with certain compounds which do not have a planes of symmetry and are thus non-superimposable on their mirror images. Dissymmetry is an essential condition for optical activity. In the study of enantiomers containing one chiral carbon atom, we find that they do not have a plane of symmetry and hence are dissymmetric in nature, for example, lactic acid, sec-butyl chloride etc. We can thus say that compounds with a chiral carbon atom are optically active in nature.

This is not true, however, for compounds with two or more chiral carbon atoms. Here, one or more isomers may be optically inactive in spite of the presence of chiral carbon atoms. Consider for example, the case of tartaric acid, $\text{CH}(\text{OH})\text{COOHCH}(\text{OH})\text{COOH}$. It has two chiral carbons (stereogenic centres) marked * and thus has four isomers as shown below:

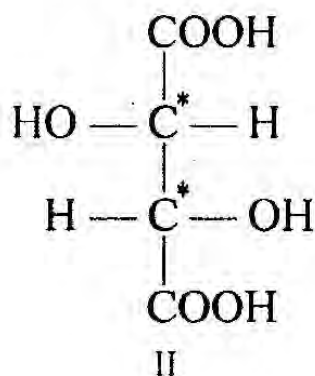
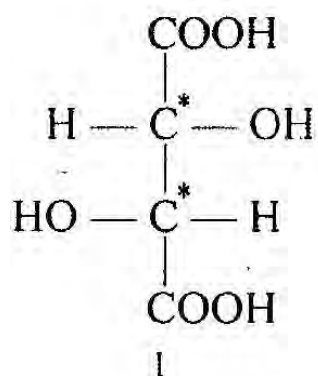

I and II are optically active due to the absence of plane of symmetry

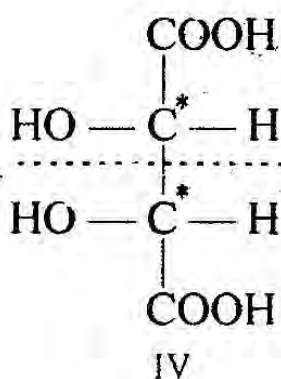
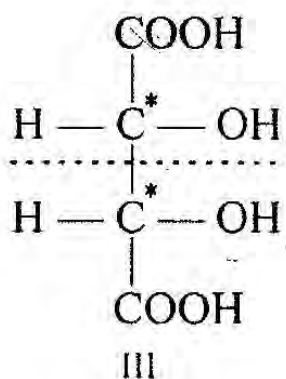

III and IV are optically inactive due to the presence of plane of symmetry (shown by dotted line)

Isomers I and II are non-superimposable mirror images of each other, they are dissymmetric and optically active. But III and IV have a plane of symmetry. Therefore, they are symmetric and optically inactive in nature. In other words, optical activity in organic compounds is due to the presence of dissymmetry and not due to chiral carbon atoms alone.

No. of optical isomers for a compound is given by 2^n where n is the number of chiral carbon atoms.

It may be noted that some organic compounds are optically active even though they do not contain chiral atom. For example, **Substituted allenes**. Dienes with double bonds in adjacent positions are called allenes. Substituted allenes may be represented as $\text{RCH} = \text{C} = \text{CHR}$. Pentane-2,3-diene exists in two optically active forms. This is because the groups linked to one end carbon are in different plane than those linked to the other end carbon.

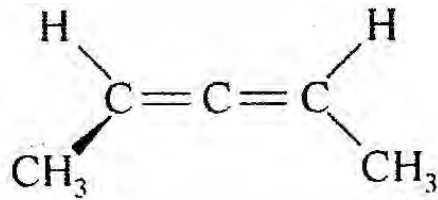
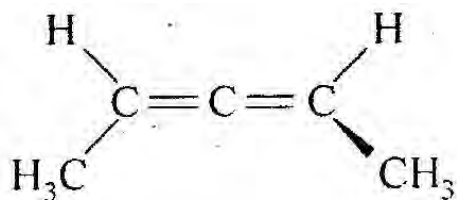

In allenes, the central carbon is sp hybridized, and the terminal carbons are sp^2 hybridized. The central carbon forms two $sp-sp^2$ sigma bonds. The central carbon also has two p orbitals which are mutually perpendicular. These form pi bonds with the p orbitals on the other carbon atoms. As a result, the substituent at one end of the molecule are in a plane which is perpendicular to

that of the substituents at the other end, so that the compound exists in two forms which are non-superimposable mirror images and are optically active.

Substituted biphenyl. Benzene rings in substituted biphenyl lie in different planes; hence the compound exhibits optical activity.

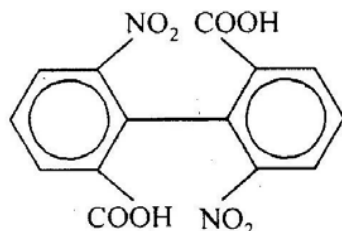

We can conclude from the above discussion that the most essential condition for a compound to show optical activity is the presence of dissymmetry and not chirality. However, compounds containing only one chiral carbon are always dissymmetric since they do not have a plane of symmetry.

The compounds, with two or more similar chiral carbon atoms which are optically inactive due to the presence of plane of symmetry, are called **meso** compounds.

Consider the following isomer of tartaric acid

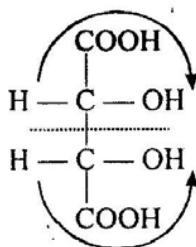

It has a plane of symmetry denoted by the denoted line. The optical rotation of upper half of the molecule is neutralized by that of the lower half as the two rotations are in opposite directions. The net result is that the molecule is optically inactive. Such compounds are known as meso compounds.

Similarly, we come across meso structures in 2, 3-Dichlorobutane. This compound also possesses two asymmetric carbon atoms (stereogenic centres) marked with *.

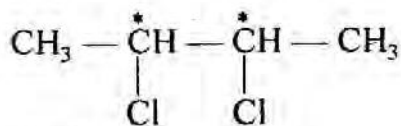

The different isomers can be written as

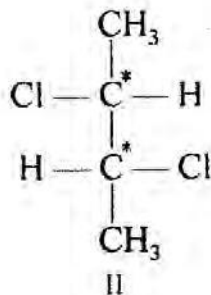
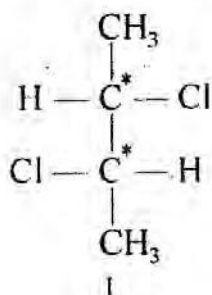

I and II show optical activity due to absence of plane of symmetry (Dissymmetry)

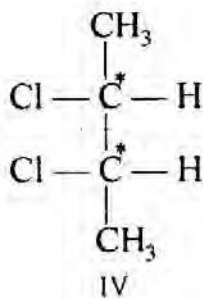
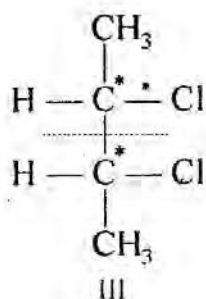

III and IV are optically inactive because of the presence of plane of symmetry

Structures III and IV are meso compounds because the optical activity of the upper half of the molecule is neutralised by that of the lower half.

Properties of enantiomers

(i) They have identical physical properties but differ in direction of rotation of plane polarised light. Though the two enantiomers rotate the plane polarised light in opposite direction, the extent of rotation is the same.

(ii) They have identical chemical properties except towards optically active reagents. The rates of reaction of optically active reagents with two enantiomers differ and sometimes one of the enantiomers does not react at all.

Example: In biological system (-) or l-glucose is neither metabolised by animals nor fermented by yeast whereas (+) or d-glucose undergoes both these processes and plays an important role in animal metabolism and fermentation. Similarly mould penicillium glaucum consumes only d-tartaric acid when fed with a mixture of equal quantities of d- and l-tartaric acid.

(iii) When equal amounts of enantiomers are mixed together an optically inactive racemic modification denoted by (\pm) or dl is obtained.

Fischer's projection formula for planar representation of three dimensional molecules.

Emil Fischer in 1891 introduced a simple method for representing three dimensional molecules in one plane. It is known as Fischer projection formula. Following points are to be observed for this purpose:

- (i) The chiral molecule is imagined in such a way that two groups point towards the observer and two away from the observer. The groups pointing towards the observer are written along the horizontal line (shown by thick wedge-like bonds) and those pointing away are written along the vertical line. The central carbon is present at the crossing of the horizontal and vertical lines.

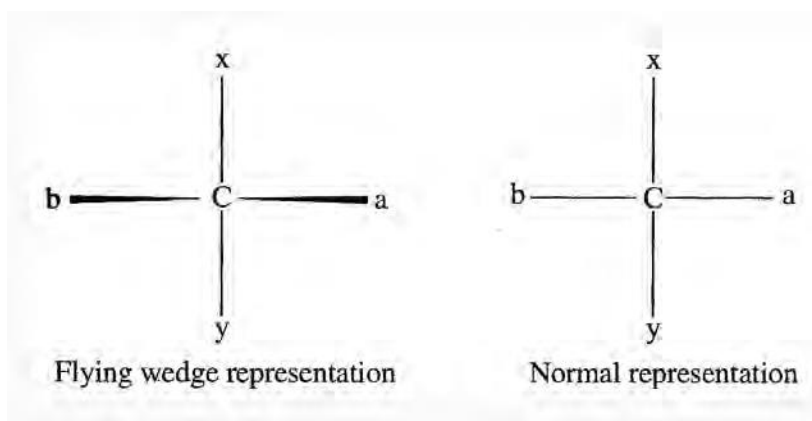

Thus if a, b, x and y are four groups attached to a carbon, the molecule will be represented by the projection formula as above. Here a and b groups point towards the observer (or above the plane) and groups x and y are away from the observer (or below the plane).

- (ii) The longest chain of carbon atoms in the molecule should be represented along the vertical line. Lactic acid, therefore, according to the above conventions will be represented as

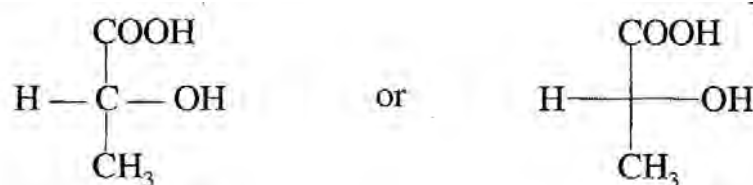

- (iii) We can avoid writing carbon at the crossing of the vertical and horizontal lines. A crossing automatically means the presence of a carbon.
- (iv) If necessary, planar formula may be imagined to be rotated from end to end without lifting it from the plane of the paper. Rotation by 180° in the plane of the paper does not create any change in the configuration of the molecule.

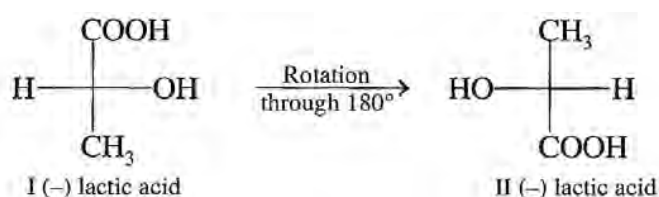

In the above rotation by 180° , II has been obtained from I. There has been no change in configuration of the molecule. I and II are in fact the same thing.

- (v) Rotation by 90° or 270° brings about a change in configuration of the molecule. Consider the following rotation.

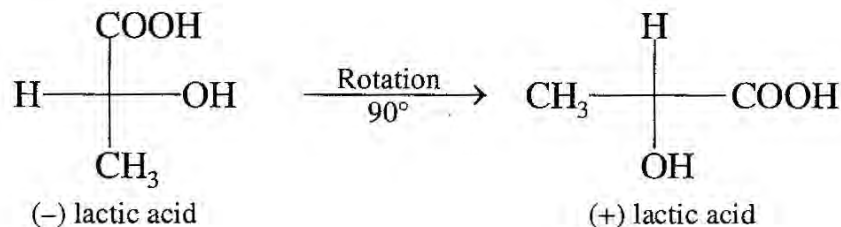

- (vi) If the positions of two groups across the chiral atom are interchanged, it leads to inversion of configuration. Two consecutive such changes neutralise the effect.

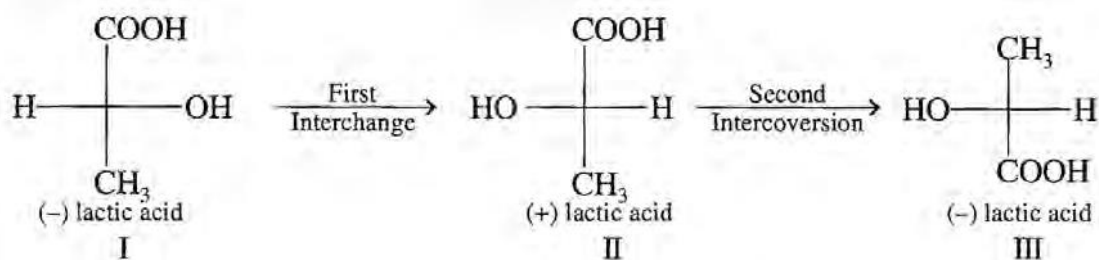

Structure III and I are the same because as per rule (iv) above, III on rotation through 180° will give I.

Absolute configuration of optical isomers

In the earlier days, as the modern techniques of finding out configuration were not available, Fischer assigned the following configurations to the (+) and (-) enantiomers of glyceraldehyde arbitrarily and denoted them by capital letters D and L, respectively. Small letters d and l represent sign of rotation, while capital letters D and L represent configuration.

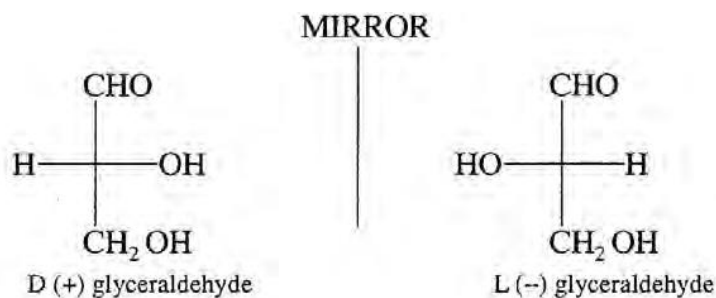

The relative configurations of a number of other optically active compounds have been established by correlating them with D(+) or L(-) glyceraldehyde. All those optically active compounds, which are obtained from D(+) glyceraldehyde through a sequence of reactions *without breaking the bonds of asymmetric carbon atom*, are designated as D configuration irrespective of their sign of rotation and the other enantiomer as L configuration.

For example,

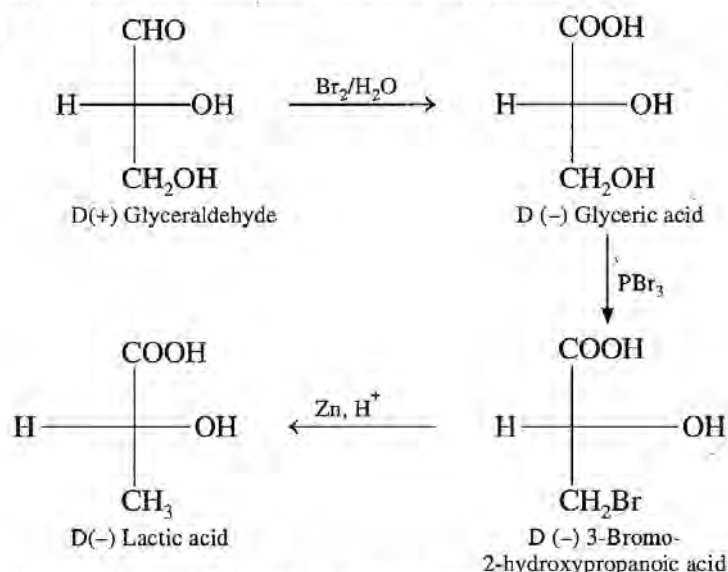

In all the D configurations, —OH attached to asymmetric carbon atom is written on the right hand side of Fischer projection formula. Similarly, in all the L-configurations, —OH attached to the lowest asymmetric carbon atom is written on the left hand side in the Fisher's projection formula.

R and S specification for the configuration of an optically active compound

Cahn, Ingold and Prelog developed a method which can be used to designate the configuration of all the molecules containing asymmetric carbon atom (chiral centre). This system is known as *Cahn-Ingold-Prelog system* or R and S system and involves two steps.

Step I. The four different atoms or groups of atoms attached to chiral carbon atom are assigned a sequence of priority according to the following set of sequence rules.

Sequence Rule 1. *If the four atoms, directly attached to asymmetric carbon atom, are all different, the priority depends on their atomic number. The atom of higher atomic number gets higher priority.* For example, in chloriodomethane sulphonic acid the priority sequence is I, Cl, SO₃H, H

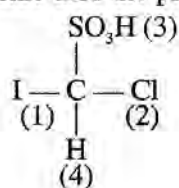

We consider the atom of the group which is directly linked to the central carbon.

Sequence Rule 2. *If Rule 1 fails to decide the relative priority of two groups it is determined by similar comparison of next atoms in the group and so on.* In other words, if two atoms directly attached to chiral centre are same, the next atoms attached to each of these atoms, are compared. For example in 2-butanol two of the atoms directly attached to chiral centre are carbon themselves. To decide the priority between the two groups —CH₃ and —CH₂CH₃, we proceed like this. Methyl carbon is further linked to H, H and H. The sum of atomic numbers of three H is 3. The methylene carbon of the ethyl group is linked to two hydrogens and one carbon directly. The sum of at. no. of two H and one C is 8. Thus ethyl group gets the priority over methyl. Hence the priority sequence is OH, C₂H₅, CH₃, H.

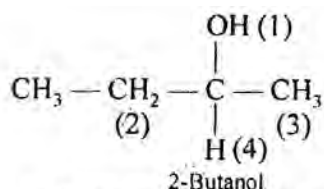

In 2-methyl - 3-pentanol, the C, C, H of isopropyl gets priority over the C, H, H of ethyl, so the priority sequence is OH, isopropyl, ethyl, H.

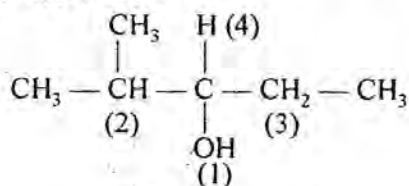

In 1, 2-dichloro-3-methylbutane the Cl, H, H of CH₂ Cl gets priority over the C, C, H of isopropyl due to atomic number of Cl being higher than that of C. So the priority sequence is Cl, CH₂Cl, isopropyl, H.

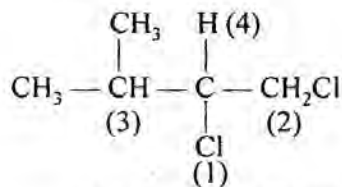

Sequence Rule 3. A doubly or triply bonded atom is considered equivalent to two or three such atoms; but two or three atoms, if attached actually, get priority over doubly or triply bonded atom. In glyceraldehyde, O, O, H of —CHO gets priority over the O, H, H of —CH₂OH; so the priority sequence is —OH, —CHO —CH₂OH —H.

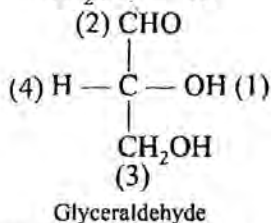

Step II. After deciding the sequence of priority for four atoms or groups attached to asymmetric carbon atom; the molecule is visualised in such a way that the atom or group of lowest or last (*i.e.* fourth) priority is directed away from us, while the remaining three atoms or groups are pointing towards us. Now if on looking at these three groups (pointing towards us) in the order of their decreasing priority, our eye moves in clockwise direction, the configuration is specified as R (from Latin word *rectus* meaning right) and on the other hand if our eye moves in anticlockwise direction the configuration is specified as S (from Latin word *sinister* meaning left).

The following examples illustrate the above method for specification of configurations of R and S to molecules of compounds containing an asymmetric or chiral carbon atom.

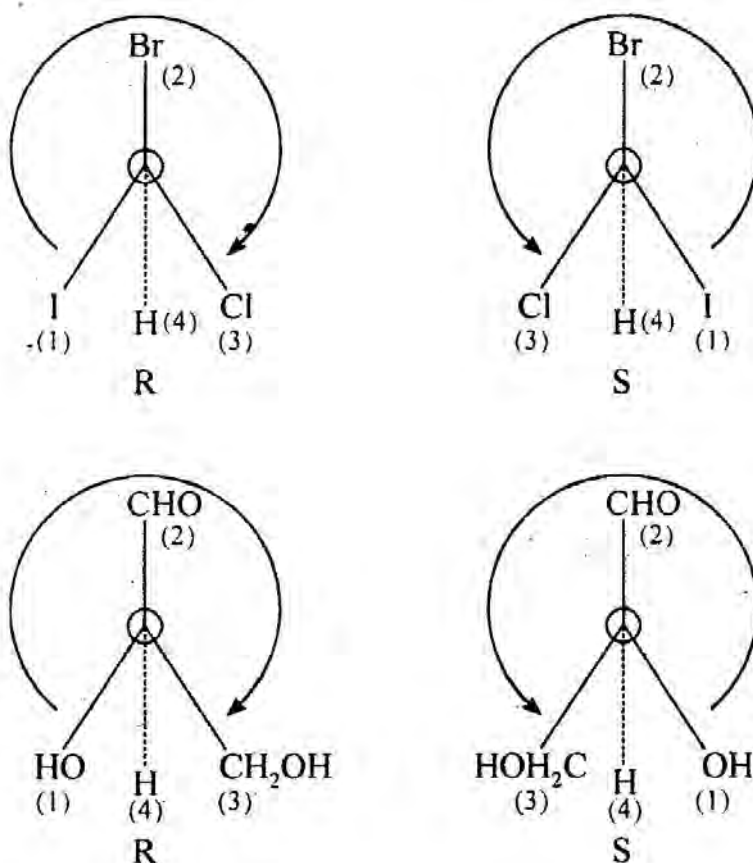

Configuration on the basis of projection formula

When a compound is represented by the Fischer projection formula, the configuration can be easily determined without constructing the model. To determine whether the eye travels clockwise or anticlockwise, we have to place the group or atom of the lowest priority at the bottom of the Fischer projection formula. The following four situations arise:

(i) The atom/group of lowest priority is at the bottom. In such a case, simply rotate the eye in the order of decreasing priorities. The configuration is R if the eye travels in clockwise direction and S if the eye travels in anticlockwise direction.

For example, Glyceraldehyde, represented by the following projection formula has R configuration:

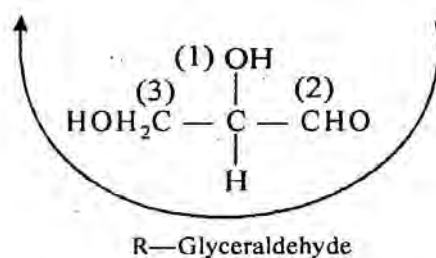

(ii) The atom/group of lowest priority is at the top. In such case, rotate the molecule by 180° so as to bring atom/group of lowest priority at the bottom. This can be done by reversing the

position of all the atoms or groups. Then find the direction in the order of decreasing priorities. For example, the compound CHBrClI , represented by following projection formula, has S configuration:

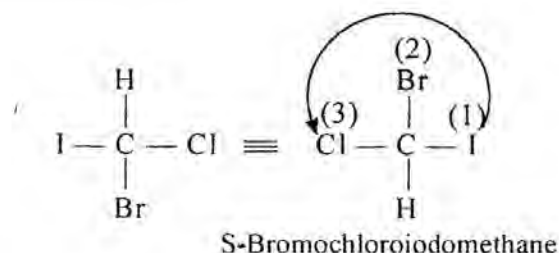

(iii) The atom/group of lowest priority is at the right hand side of the horizontal line. In such case, change the position of atoms or groups in clockwise direction so that atom/group of the lowest priority comes at the bottom but do not change the position of the atom/group at the top of the vertical end. Then find the direction in the order of decreasing priorities. For example, CHBrClI , represented by following projection formula, has S configuration.

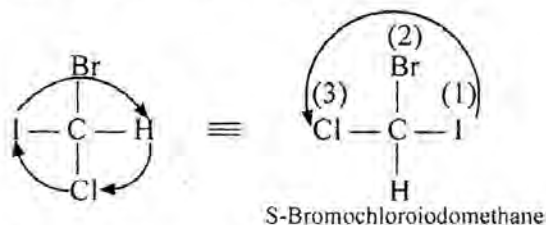

(iv) The atom/group of lowest priority is at the left hand side of the horizontal line. In such case, without changing the position of atom/group at the top of the vertical end, change the position of other atoms/groups in the anticlockwise direction so that atom/group of lowest priority comes at the bottom. Then find the direction in the order of decreasing priorities. For example, CHBrClI , represented by following projection formula, has R configuration.

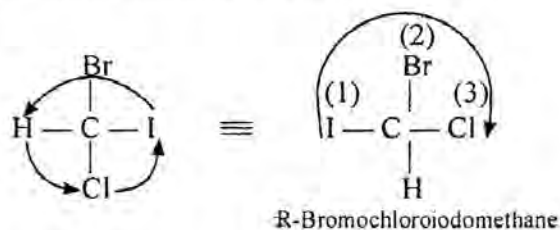

Racemic modifications

Racemic modification is the term used for a mixture of equal amounts of enantiomers. A racemic mixture is optically inactive because of external compensation. The optical activity caused by one enantiomer is neutralised by the activity of the other enantiomer. The notation for a racemic modification or mixture is \pm or dl. A racemic mixture may also be denoted by the letters R and S. For examples RS-sec. butyl chloride.

Methods for the resolution of racemic mixtures

The separation of racemic modification into enantiomers is called resolution. Since the two enantiomers in a racemic mixture have identical physical and chemical properties, These

cannot be separated by usual methods of fractional distillation or fractional crystallisation. Special methods are adopted for their separation as given below:

(i) Mechanical separation. This method was first adopted by Pasteur for separating the enantiomers of ammonium tartarate. When racemic modification is crystallized from a solution, two types of crystals are obtained. These are mirror images of each other consisting of (+) and (-) forms which can be separated by hand picking with the help of a pair of tweezers and a powerful lens. This is a very laborious method and can be applied only to those compounds which give well defined distinguishable crystals of enantiomers.

(ii) Biochemical method. Certain micro-organisms grow in a racemic mixture, consuming only one of the enantiomers while leaving the other unaffected. Thus penicillium glaucum when placed in (+) tartaric acid, consumes only (+) tartaric acid and leaves (-) tartaric acid unused. The major disadvantage of this method is that one of the enantiomers get destroyed.

(iii) Chemical method. This method is mostly used for the resolution of racemic modification. In this method the racemic modification is treated with an optically active reagent to get a pair of diastereomers. Since diastereomers differ in their physical properties, it is possible to separate them by physical methods such as fractional crystallisation, fractional distillation etc. The pure diastereomers are then decomposed, into a mixture of optically active reagent and corresponding enantiomer, which can be separated.

Suppose the racemic modification is an (\pm) acid. When it is treated with an optically active, say (-) base, it gives a mixture of two salts, one of (+) acid (-) base, the other of (-) acid (-) base. These salts are neither superimposable nor mirror images; so these are diastereomers having different physical properties and can be separated by fractional crystallisation. After separation the optically active acids can be recovered in pure forms by adding a mineral acid.

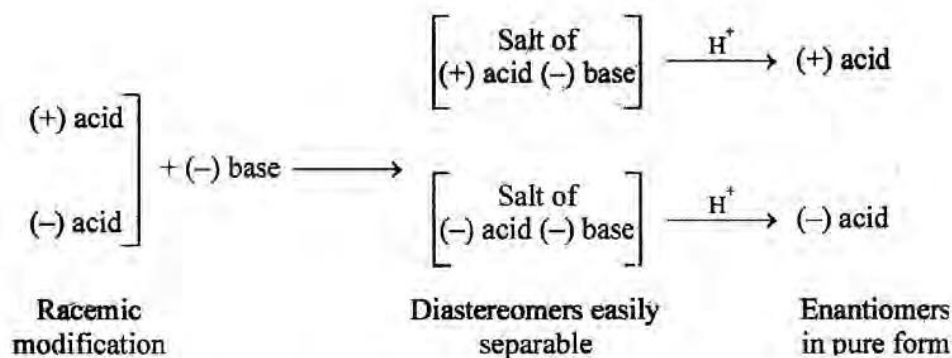

The commonly used optically active bases for the purpose are naturally occurring alkaloids such as (-) brucine, (-) quinine, (-) strychnine and (+) cinchonine.

Similarly, the resolution of racemic bases can be carried out using a naturally occurring optically active acid such as (-) malic acid. Alcohols can be resolved in a similar way by ester formation using an optically active acid.

CONFORMATIONAL ISOMERISM

Carbon-carbon single bond in alkanes is a sigma bond formed by the overlapping of sp^3 hybrid atomic orbitals along the inter-nuclear axis. The electron distribution in such a bond is symmetrical around internuclear axis; so that free rotation of one carbon against the other is possible without breaking sigma or single covalent bond. Consequently such compound can have different arrangements of atoms in space, which can be converted into one another simply by rotation around single bond, without breaking it. These different arrangements are known as *Conformational Isomers* or *Rotational Isomers* or *Conformers*. Since the potential energy barrier for their inter-conversion is very low, it is not possible to isolate them at room temperature. At least 60-85 kJ/mole must be the energy difference between two conformers to make them isolatable at room temperature.

Hence, conformations can be defined as different arrangements of the atoms which can be converted into one another by rotation around single bonds.

Newman and Sawhorse representations for the conformations of ethane

Alkanes can have an infinite number of conformations by rotation around carbon-carbon single bonds. In ethane two carbon atoms are linked by a single bond and each carbon atom is further linked with three hydrogen atoms. If one of the carbon atoms is allowed to rotate about carbon-carbon single bond keeping the other carbon stationary, an infinite number of arrangements of the hydrogens of one carbon, with respect to those of the other, are obtained. All these arrangements are called conformations (Bond angles and bond lengths remain the same).

Newman representation

This can be easily understood with the help of Newman Projection formulae. The molecule is viewed from front to back in the direction of carbon-carbon single bond. The carbon nearer to the eye is represented by a point and three hydrogen attached to it are shown by three lines at an angle of 120° to one another. The carbon atom away from the eye is represented by a circle and three hydrogens attached to it are shown by shorter lines at an angle of 120° to each other.

Out of infinite number of conformations, Newman Projection formulae for two extreme cases are as shown below:

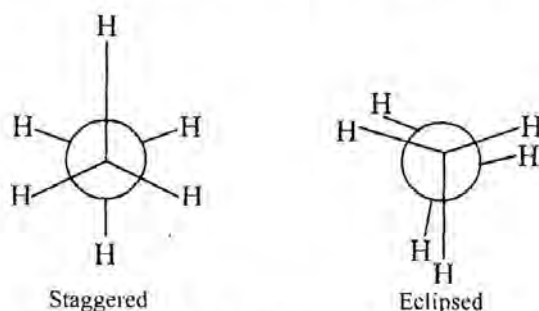

Newman Projection Formulae for conformations of ethane.

The conformation in which the H atoms of two carbons are as far apart as possible, is known as *Staggered conformation* and the conformation in which the H atoms of back carbon are just behind those of the front carbon is known as a *Eclipsed conformation*. These are converted into one another by rotation of one carbon against the other through 60° . The other conformations, in between these two, are known as *skew conformations*.

Sawhorse representation

In this representation, the molecule is visualised slightly from above and from the right and then projected on the paper. The bond between two carbons is drawn diagonally and is a bit longer for the sake of clarity. The lower left hand carbon is taken as front carbon and the upper right hand carbon is taken as back carbon. The Sawhorse representation of staggered and eclipsed conformations of ethane are given below :

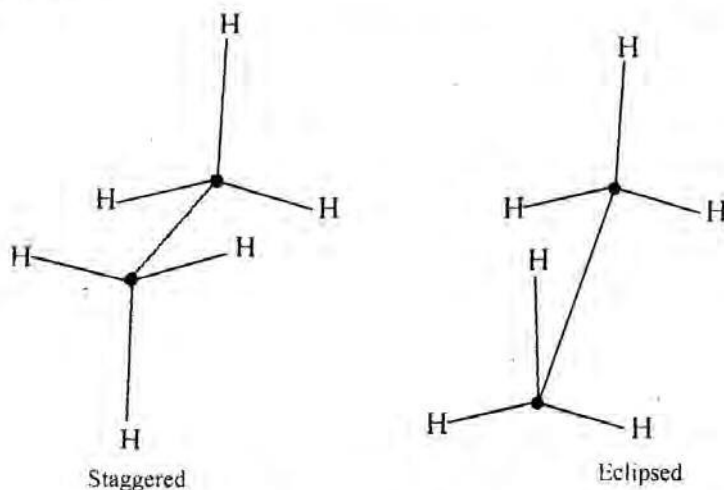

Sawhorse representation for conformations of ethane

Pitzer in 1936 found that the rotation is not completely free. Rather there exists a potential energy barrier which restricts the free rotations. It means that the molecule spends most of its time in the most stable staggered conformation and it spends least time in the least stable eclipsed conformation; the energy difference being 12 kJ/mole in the case of ethane.

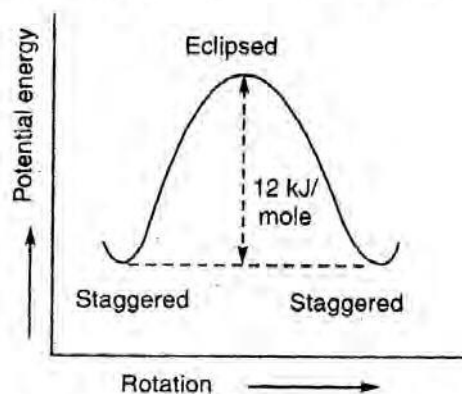

Rotational or torsional energy of ethane

The energy required to rotate the molecule about carbon-carbon bond is called rotational or torsional energy.

Difference between conformation and configuration

Conformation

Structures containing different arrangement of atoms of a molecule in space which can arise by rotation about a single bond are called *conformers*. For example ethane exists in different conformations called staggered, eclipsed and skew conformations. The energy difference between different conformers is rather small. This phenomenon is called conformation. The property of conformation is also exhibited by *n*-butane, cyclohexane, stilbene dichloride etc.

Configuration

Structures of a compound differing in the arrangement of atoms or groups around a particular atom in space are called *configurations*. Enantiomers, diastereomers and geometrical isomers come under this category. For example *d*- and *l*-lactic acids are configurations of lactic acid.

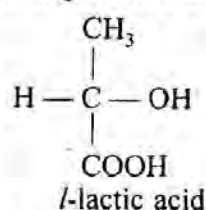
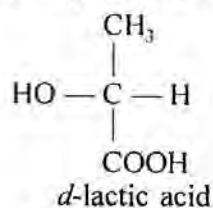

cis and *trans* butenes are configuration of butene

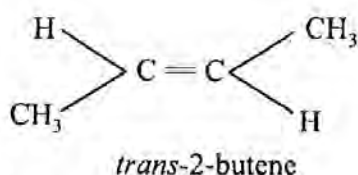
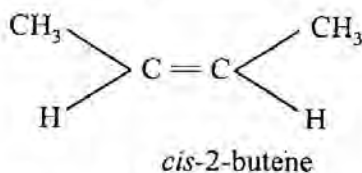

Factors affecting relative stability of conformations

The following factors play a vital role in the stability of conformations.

1. **Angle strain.** Every atom has the tendency to have the bond angles that match those of its bonding orbitals. If there is any deviation from this normal bond angle, the molecule suffers from *angle strain*. Conformations suffering from angle strain are found to be less stable.

2. **Torsional strain.** There is a tendency on the part of two carbons linked to each other to have their bonds staggered. That is why the staggered form of any molecule like ethane, *n*-butane is most stable. As the bonds of two connected carbons move towards eclipsed state, a *torsional strain* is set up in the molecule thus raising its energy. Thus the staggered conformations have the least and eclipsed the highest torsional strain. The energy required to rotate the molecule around the carbon-carbon bond is called *torsional energy*.

3. **Steric strain (van der Waals' Strain).** Groups attached to two linked carbons can interact in different ways depending upon their size and polarity. These interactions can be attractive or repulsive. If the distance between the groups or atoms is just equal to the sum of their van der Waals' radii, there will be attractive interactions between them. And if these atom or groups are brought closer than this distance, there will be repulsions leading to *van der Waals' strain* or *steric strain* in the molecule.

4. **Dipole-dipole Interactions.** Atoms or groups attached to bonded carbons orient or position themselves to have favourable dipole-dipole interactions. It will be their tendency to have maximum dipole-dipole attractions. Hydrogen bond is a particular case of powerful dipole-dipole attractions.

The stability of a conformer is determined by the net effect of all the above factors.

Conformations and change in dipole-moment of 1, 2-dibromoethane with temperature

The conformations of 1, 2 dibromoethane have been extensively studied by dipole-moment measurement. The conformations are depicted as under :

In the liquid state, the percentage of anti forms is 65 corresponding to conformational free energy of 3.5 kJ mol^{-1} in favour of *anti*.

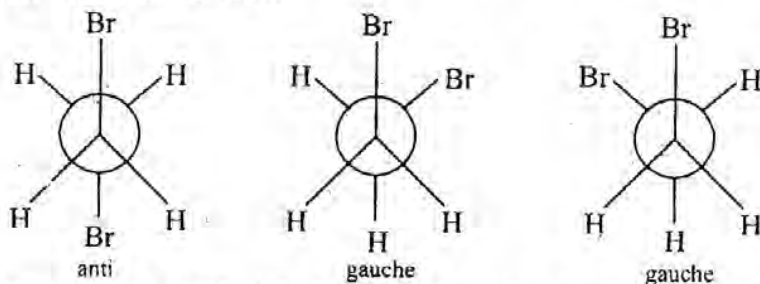

stability of *anti*-form is due to combined effects of steric factor and dipole-dipole interactions. It goes in favour of formation of *anti*- conformer. Dipole moment increases with increase of temperature.

Conformations of butane

n-butane is an alkane with four carbon atoms, which can be considered to be derived from ethane by replacing one hydrogen on each carbon with a methyl group. If we consider the rotation about the central carbon-carbon bond ($\text{C}_2 - \text{C}_3$), the situation is somewhat similar to ethane; but *n*-butane has more than one staggered and eclipsed conformations (unlike ethane which has only one staggered and one eclipsed conformation). Newman Projection formulae for various staggered and eclipsed conformations of *n*-butane are as given below :

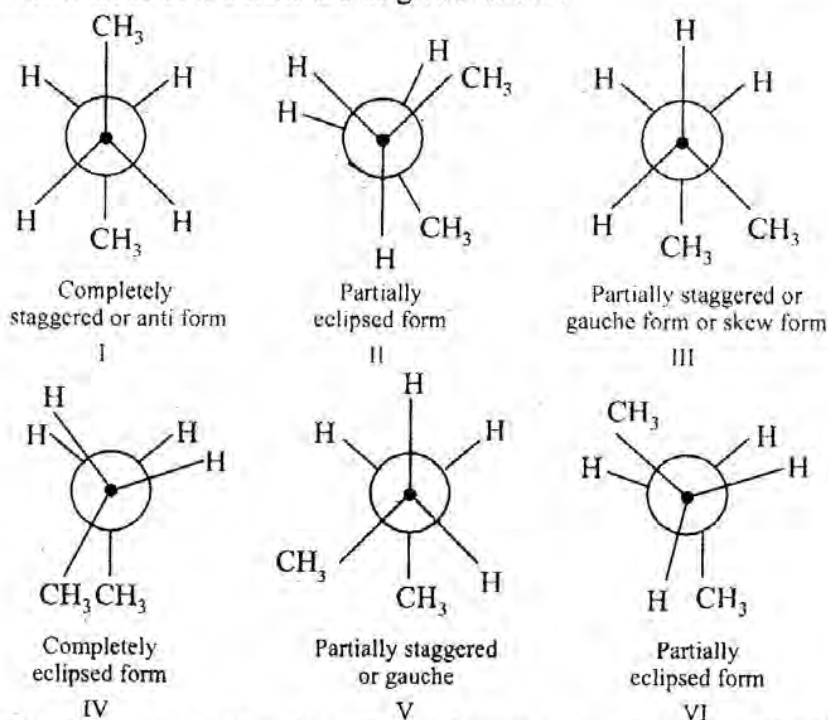

The *completely staggered* conformation, (I) also known as *anti* form, is having the methyl groups as far apart as possible. Let us see how these forms have been obtained. Let us start from structure I. Holding the back carbon (represented by circle) fixed along with its groups, — H, — H and — CH_3 , rotate the front carbon (shown by a dot) in clockwise direction by an angle of 60° . Groups attached to it will also move. *Partially eclipsed* form (II) is obtained. In this conformation (II), methyl group of one carbon is at the back of hydrogen of the other carbon. Further rotation of 60° leads of a *partially staggered* conformation (III), also known as *gauche* form, in which the two methyl groups are at an angle of 60° . Rotation by another 60° gives rise to a *fully eclipsed* form (IV) having two methyl groups at the back of each other. Further rotation of 60° , again leads to *partially staggered or gauche* form (V) having methyl groups at an angle of 60° (as in III). Still further rotation of 60° leads to

partially eclipsed form (VI), having methyl group of one carbon at the back of hydrogen of the other (as in II). If a further rotation of 60° is operated (completing the rotation of 360°), again form I is obtained. Of course, there will be an infinite number of other conformations in between these six conformations (I to VI). (*Gauche* form is also known as skew form).

Out of these six conformations, the *completely staggered* or *anti conformation* (I) is most stable and *partially staggered* or *gauche conformation* (III or V) is slightly less stable; the energy difference being only 3.8 kJ/mole. On the other hand the *completely eclipsed* conformation (IV) is least stable and *partially eclipsed* conformation (II or VI) is slightly more stable, again the energy difference being 3.8 kJ/mole. (This is due to presence of steric strain between two methyl groups). The energy difference between most stable conformation (I) and least stable conformation (IV) is about 18.4 kJ/mole while that between I and II (or VI) is about 14.6 kJ/mole.

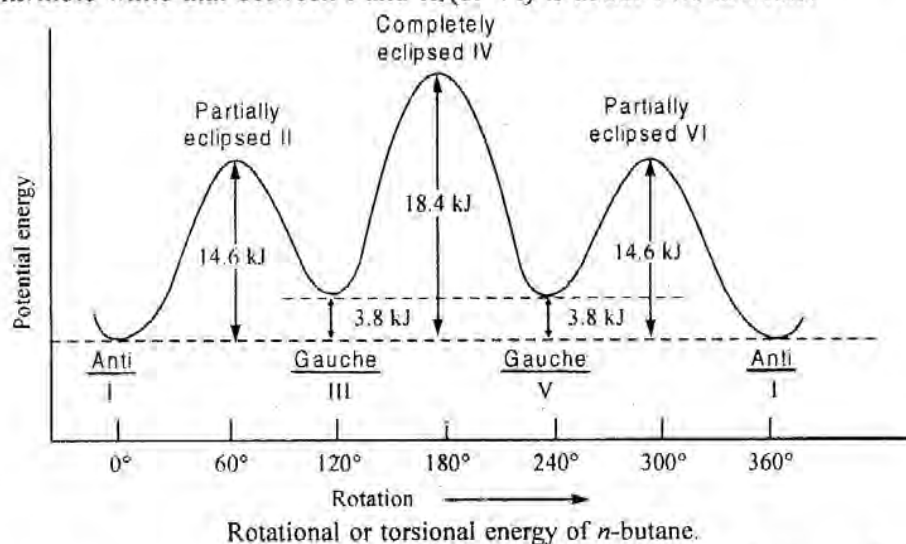

Thus at ordinary temperature, *n*-butane molecule exists predominantly in *anti* form with some *gauche* forms.

Conformational enantiomers of 2, 3-Dimethylbutane and 2, 2, 3-Trimethylbutane

Conformational isomers of 2,3-Dimethylbutane

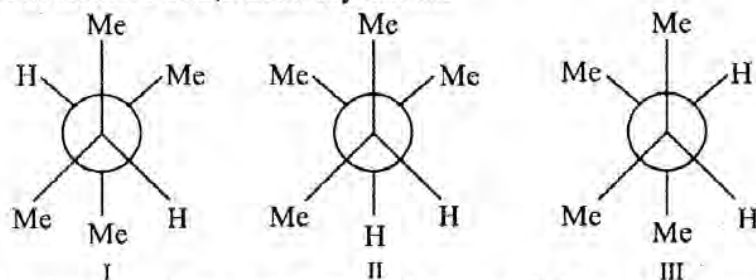

Structure I is supposed to have maximum stability out of these three isomers, II and III are conformational enantiomers (mirror-images) also. This can be visualized after rotation of III as a whole.

Conformational isomers of 2, 2, 3-Trimethylbutane

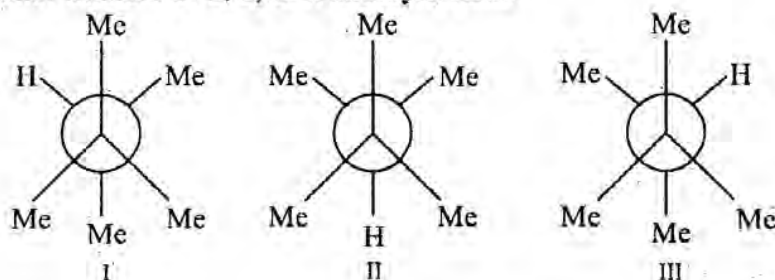

All these structures have the same stability and the compound may be assumed to occur in one conformation only.

Conformations of cyclohexane

Chair conformation

Chair conformation of cyclohexane is represented below :

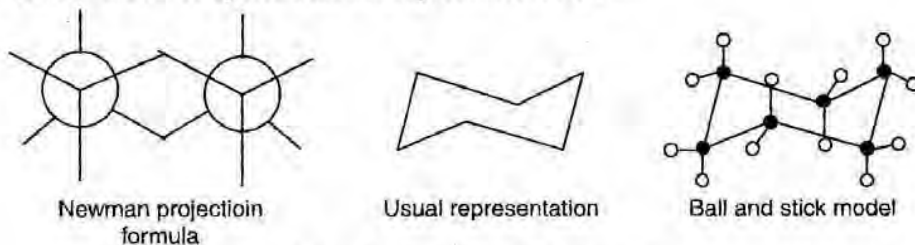

Chair conformation of *n*-butane.

This is the most stable conformation of cyclohexane. In this conformation, all the bond angles are tetrahedral and the C — H bonds on adjacent carbons are in a staggered position. This conformation has no strain and has minimum energy.

Boat Conformation

There is no angle strain in the molecule as all the angles are tetrahedral. But hydrogens on four carbon atoms (C_2 and C_3 , C_5 and C_6) are eclipsed. As a result, there is considerable torsional strain. Also, two hydrogens pointing towards each other at C_1 and C_4 (called flagpole hydrogens) are very close to each other. This brings in van der Waals strain in the molecule. Due to these reasons boat conformation is less stable than chair conformation by an amount 28.8 kJ/mole.

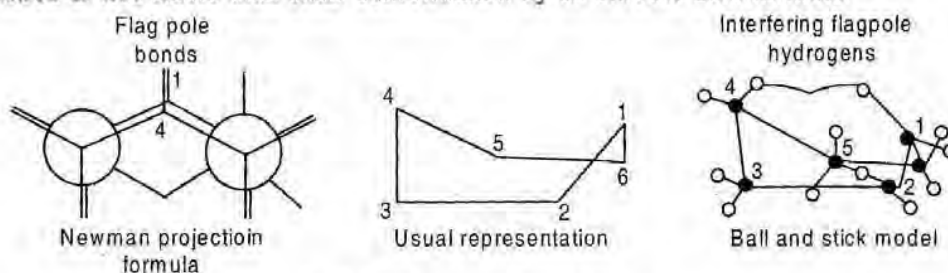

Boat conformation of cyclohexane

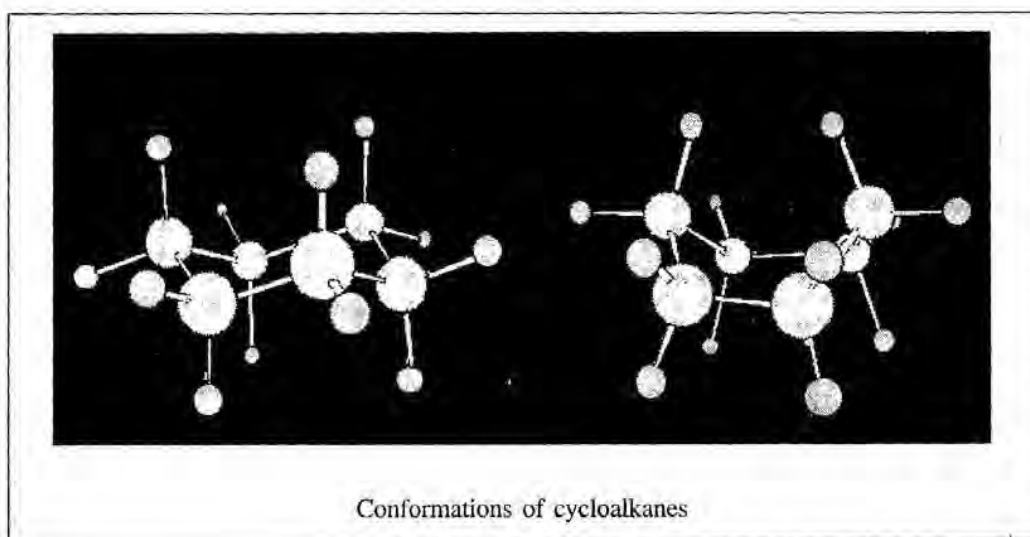

Conformations of cycloalkanes

Twist conformation of cyclohexane. Sequence of changes in going from chair form to boat form

Besides chair and boat conformation, cyclohexane can have several other possible conformations. Consider model of boat conformation of cyclohexane. Hold $C_2 - C_3$ bond in one hand and $C_5 - C_6$ in the other and twist the model so that C_2 and C_5 come upwards and C_3 and C_6 go downwards. We will get another conformation known as *twist form* or *skew boat form*.

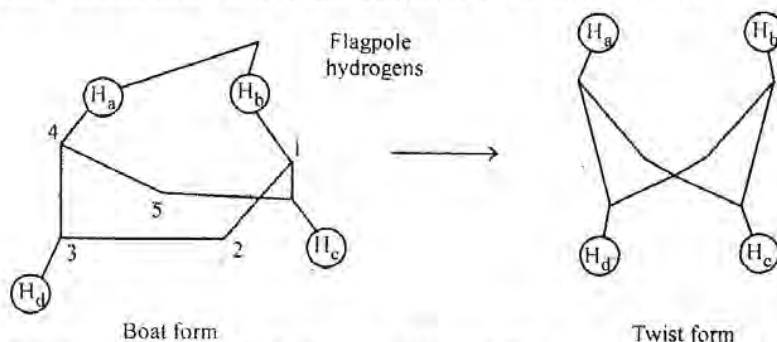

During this twisting, the flagpole hydrogens (H_a and H_b) move apart while the hydrogens H_c and H_d move closer. If this motion is continued another boat form will be obtained in which H_c and H_d become the flagpole hydrogens.

In twist forms the distance between H_a and H_b is equal to that of H_c and H_d and the steric strain is minimum; also the torsional strain of $C_2 - C_3$ and $C_2 - C_6$ (due to their being eclipsed) is partly relieved. Thus the twist form is more stable than boat form by about 5.4 kJ/mole, but it is much less stable than chair form by 23.4 kJ/mole.

If we want to convert the chair form into boat form it will have to pass through a half chair form having considerable angle strain and torsional strain. The energy difference between chair form and half chair form being about 11 kcal/mole, half chair form is quite unstable.

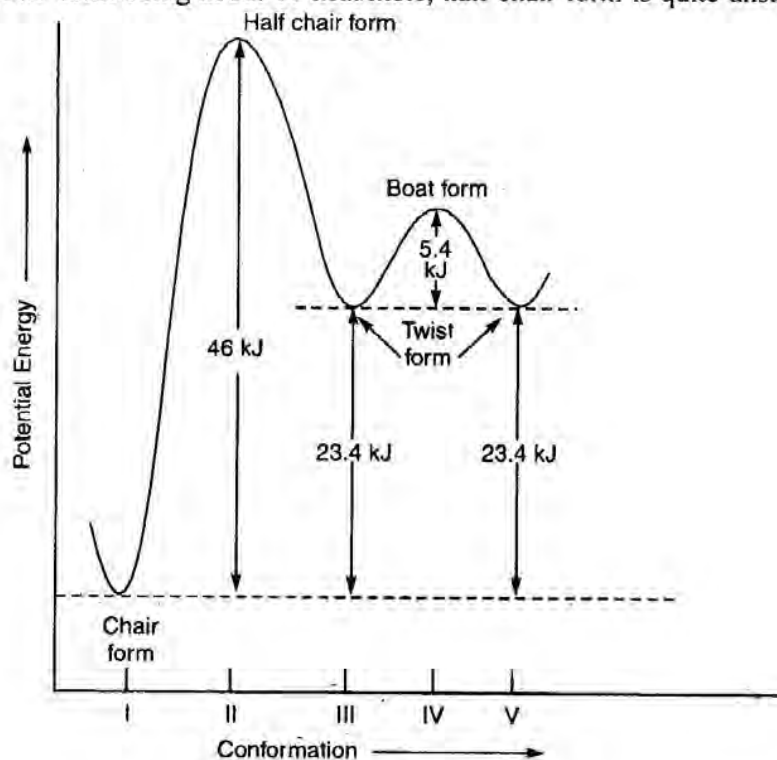

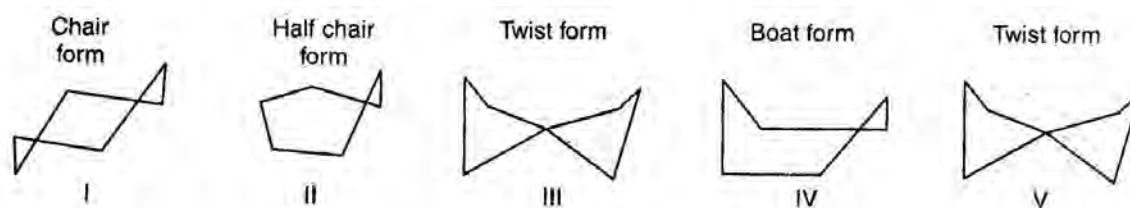

Equatorial and axial bonds in cyclohexane

Consider the structure of chair form of cyclohexane as given below :

Although, the cyclohexane ring is not planar completely, but for approximation, we can take it as planar. Consider the position of various hydrogens in the chair conformation. There are two distinct kinds of hydrogens, Six of the hydrogens which are marked H_e are almost oriented within the plane of cyclohexane ring. These are called **Equatorial hydrogen atoms**. The bonds by which these are held to the ring are called **Equatorial bonds**.

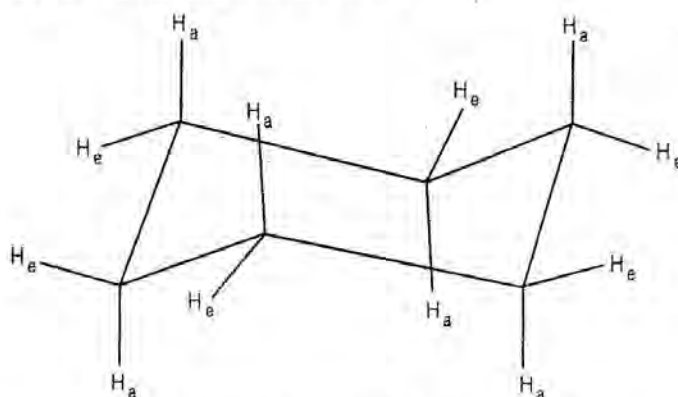

Equatorial and axial bonds in cyclohexane.

We again observe that six hydrogen atoms which are shown as H_a in the figure above are oriented perpendicular to the cyclohexane ring. These are called **Axial hydrogen atoms** and the bonds by which they are held to the ring are called **Axial bonds**.

It may be noted that there is one axial and one equatorial hydrogen on each carbon in the chair conformation of cyclohexane.

1, 3-diaxial interaction

Consider the chair model of cyclohexane. Looking at the molecule, we find that six hydrogens lie in the plane while six lie above or below the plane. Six bonds holding hydrogens in the plane are called *equatorial bonds* and six bonds holding hydrogens above or below the plane are called axial bonds. By and large, there is no stress in the molecule and it is as stable as staggered ethane.

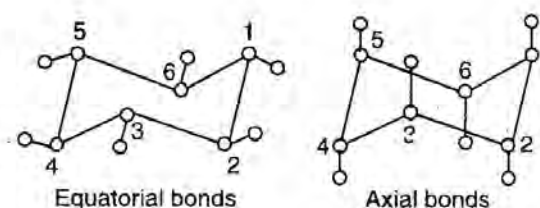

If a hydrogen is replaced by a larger group or atom, then crowding occurs. Atoms linked by axial bonds on the same side face severe crowding. This interaction is called 1, 3-diaxial interaction. Generally speaking, atoms or groups have more free space in equatorial position than in axial position.

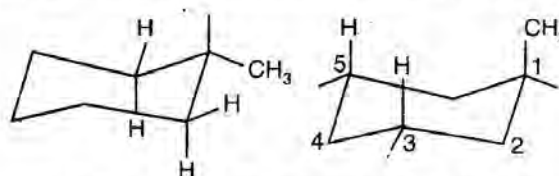

1, 3-diaxial interactions in methyl cyclohexane

There are two possible chair conformations of methyl cyclohexane one with $-\text{CH}_3$ in equatorial position and the other with $-\text{CH}_3$ in axial position.

It is observed that $-\text{CH}_3$ in equatorial position faces less crowding by hydrogens compared to $-\text{CH}_3$ in the axial position. Methyl group in the axial position is approached more closely by axial hydrogens on C - 3 and C - 5. This is called *1, 3-diaxial interaction*.

Wedge, Fischer, Newmann and Sawhorse Projection interconversions

• **Fischer projection to Sawhorse and vice-versa:**

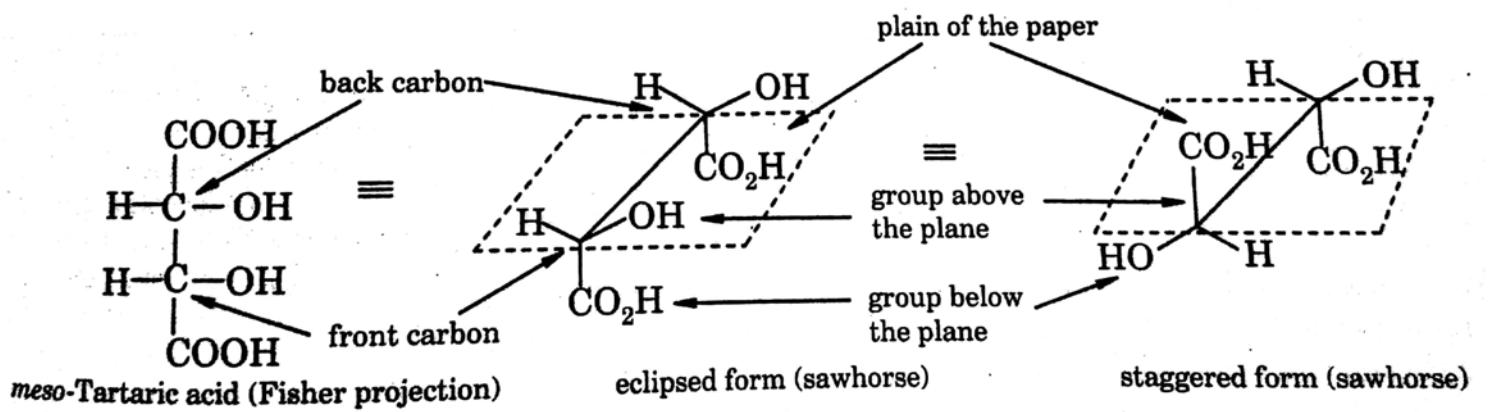

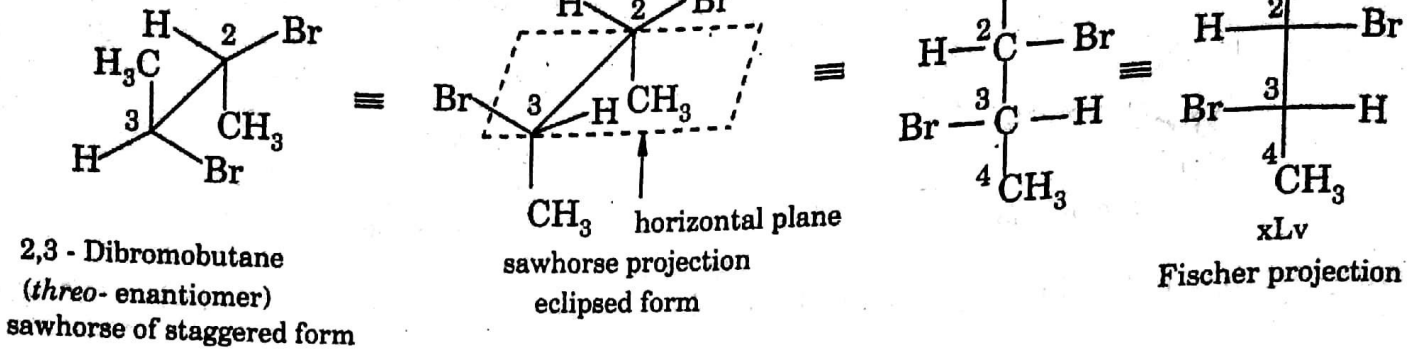

Fig. 2. 66

It is evident from the above examples that conversions of Fischer to sawhorse and *vice-versa* can be easily carried out through eclipsed form of sawhorse with proper numbering of carbon atoms, otherwise transformation may lead to a mirror image (other enantiomer). In conversions, the last chiral centre in Fischer projection (counting from the top) may be considered as the front carbon in sawhorse formula. In transposing chiral centres of eclipsed sawhorse to Fischer, if we write the front carbon as back and *vice-versa* then we will actually get the mirror image of the original configuration.

For example, in case of 2,3-dibromobutane (as shown in the above example, xLv) if the sawhorse form is written as C-2 in front and C-3 as back carbon, then the eclipsed form becomes (xLvi) and its Fischer projection will be as shown by structure (xLvii). (xLvii) is in fact the mirror image of (xLv). Therefore, we are getting the mirror image configuration of the original stereoisomer (xLv).

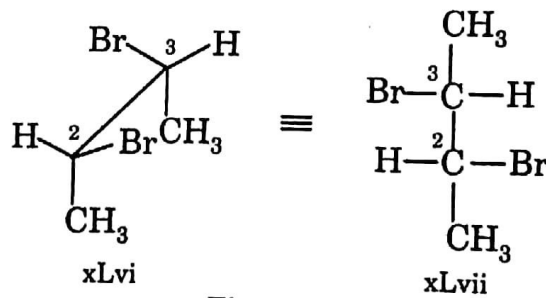

Fig. 2. 67

• **Sawhorse to Newman to Fischer and vice-versa:**

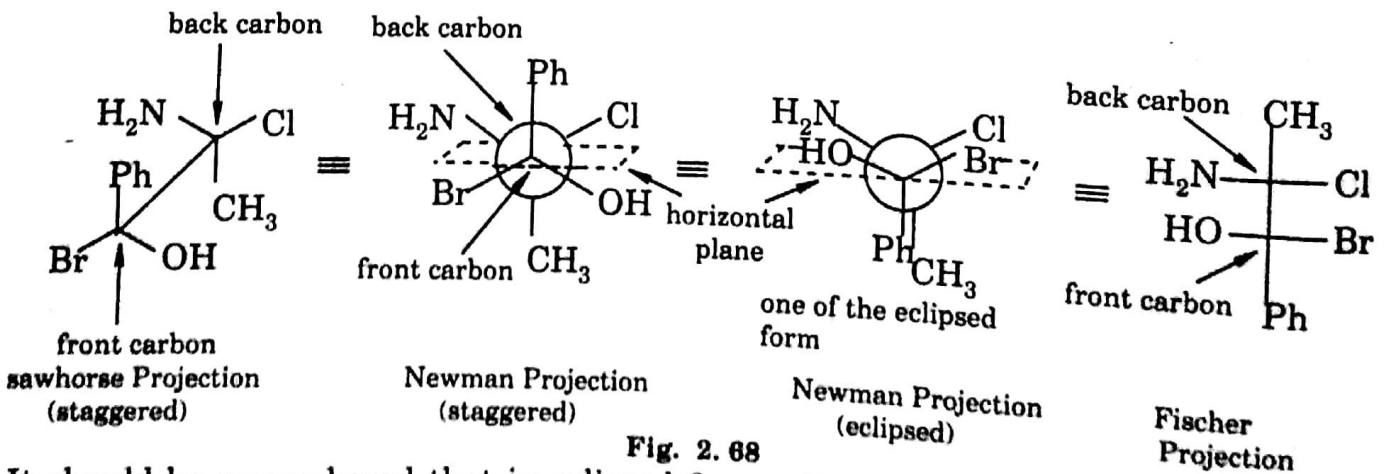

Fig. 2. 68

It should be remembered that in eclipsed form of Newman projection, the vertical bonds shown by dotted line, and transformation to Fischer projection is then carried out keeping front chiral atom as the lowest chiral centre in the Fischer projection (counting from the top).

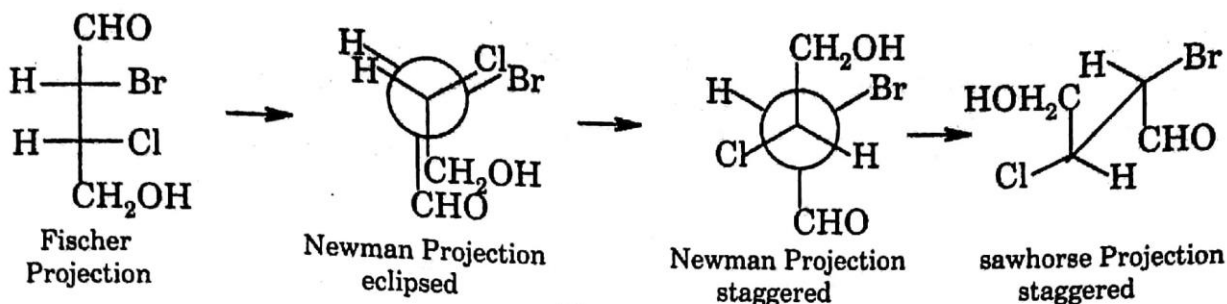

Fig. 2.69

Fischer Projection to Flying wedge and vice-versa:

Conversion of Fischer projections to flying wedge and *vice-versa* may be carried out as follows.

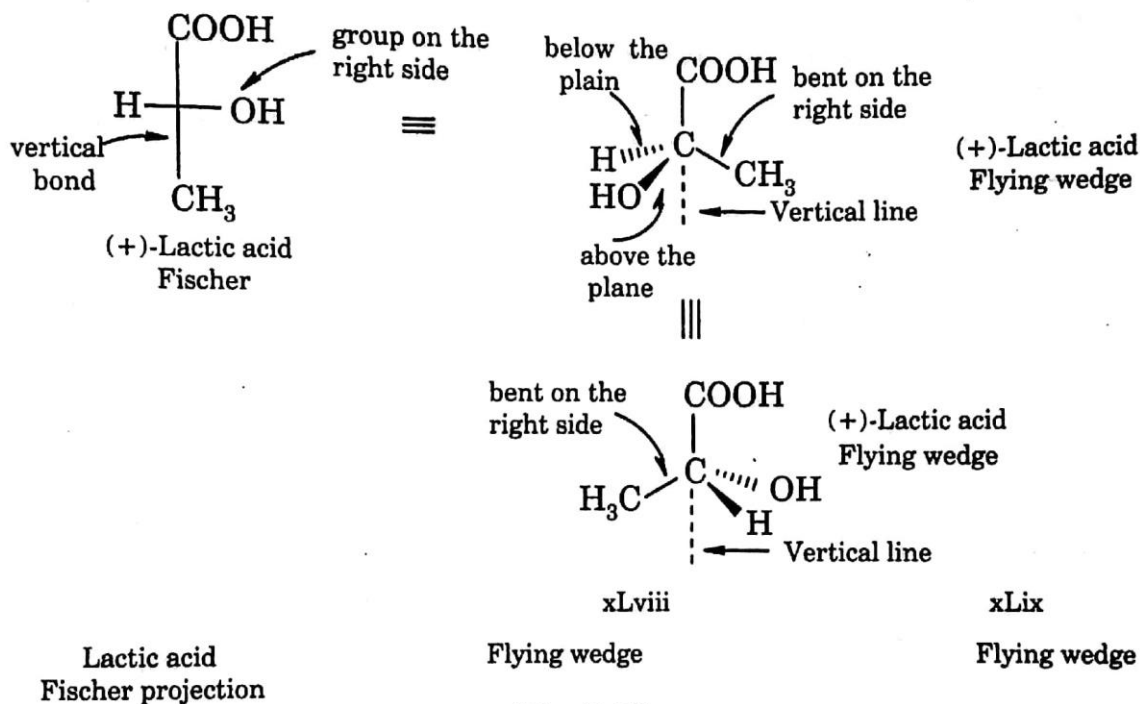

Fig. 2.70

In the above example (Fig. 2.70) Fischer projection of one of the stereoisomers of lactic acid is converted into flying wedge (xLviii, xLix) forms. In doing so, vertical bonds in Fischer projection are considered to be in the plane of the paper and horizontal bonds are to be above and below the plane.

Note that when lower vertical bond linked to $-\text{CH}_3$ group in Fischer projection is bent on the right side in xLviii, the group ($-\text{OH}$) on the right side in the horizontal bond in Fischer projection should be written above the plane of the paper (represented by solid wedge, —), the H atom, therefore, should be placed below the plane (represented by hashed wedge, ---). If the lower bond linked to CH_3 group in Fischer projection is bent on the left side (as in xLix), the group on the left side in the horizontal bond in Fischer projection is to be placed above (—) the plane of the paper and group on the right side (H) should be placed below (---) the plane. Thus, both xLviii and xLix represent the flying wedge forms of Fischer projection of same isomer of lactic acid, shown above.

The reverse method may be followed to convert a flying wedge representation to Fischer projection. An example is given below (Fig. 2.71).

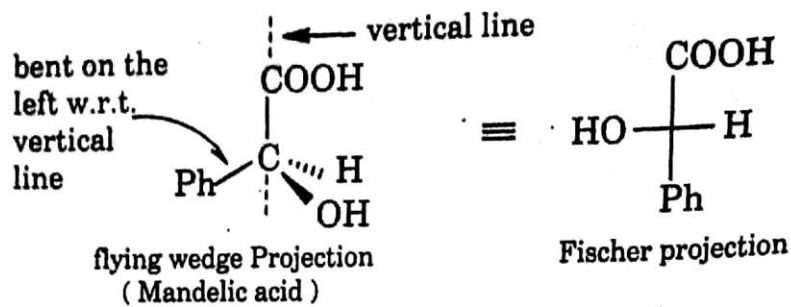

Fig. 2. 71

In the above example, CO₂H and Ph groups are in the plane of the paper in flying wedge representation. In transforming into Fischer projection, the OH group, which is above the plane in flying wedge structure, is put on the left in horizontal bond in Fischer projection, because Ph group in flying wedge projection is bent on the left side with respect to the vertical lines in Fischer projection.

A few more conversions of different flying wedge forms to Fischer projections are given below (Fig. 2.72- 75)

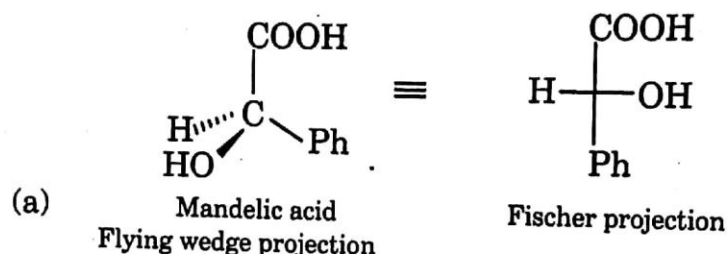

Fig. 2. 72

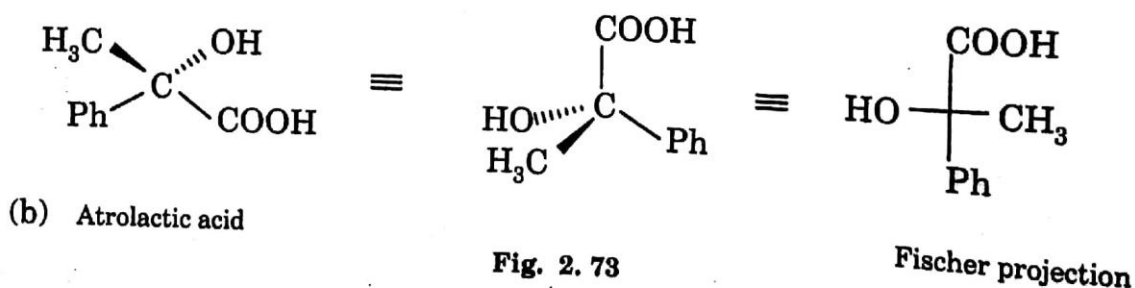

Fig. 2. 73

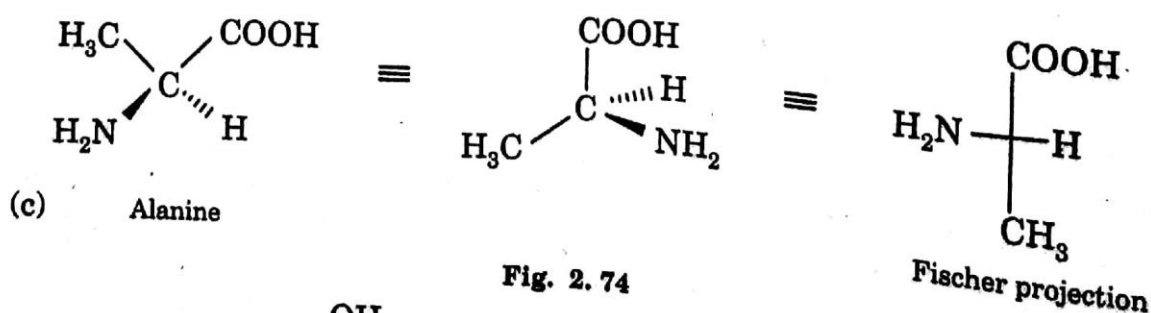

Fig. 2. 74

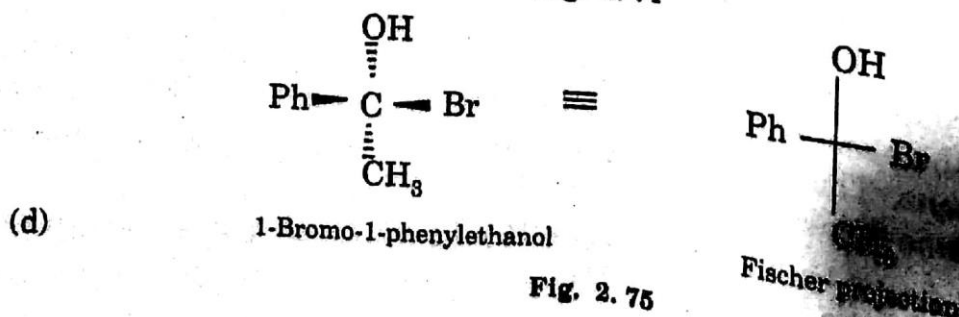

Fig. 2. 75

In the above example (d), horizontal bonds are shown above the plane and vertical bonds below the plane and these are in accordance with the Fischer convention. Therefore, in Fischer projection, the positions of atoms and groups are retained as they were in the form showing by solid and broken bonds.

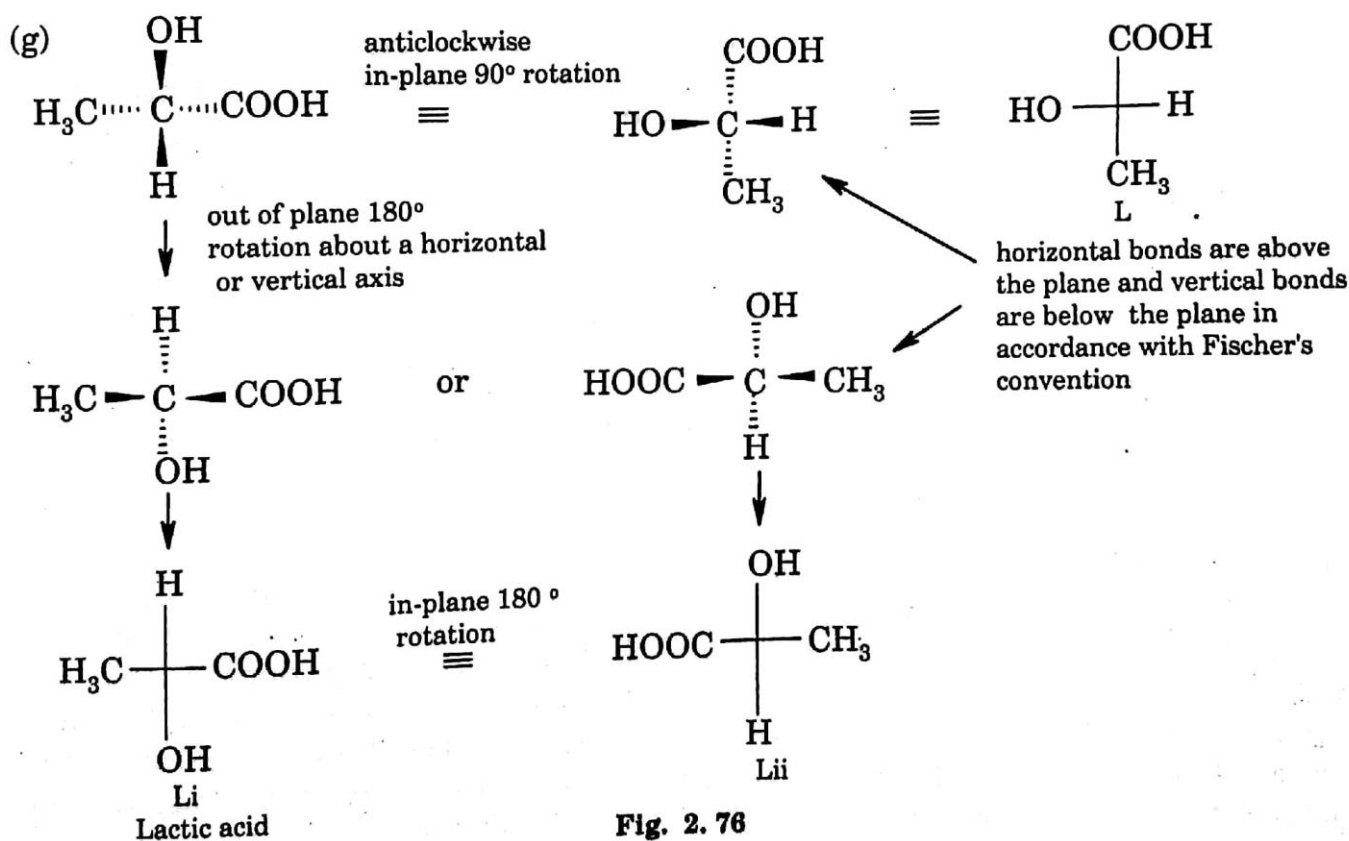
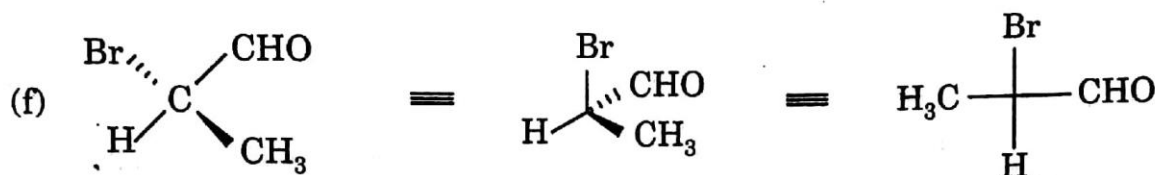
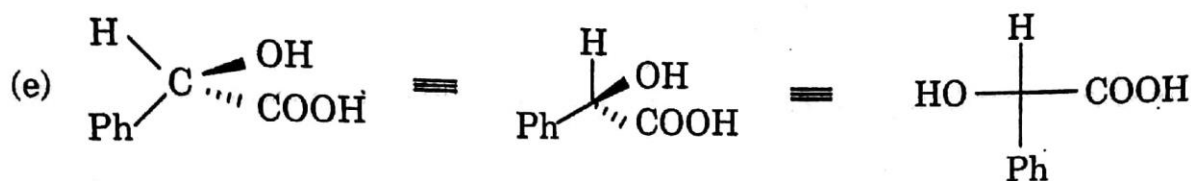

Fig. 2. 76

In example (g), the given structure is not the correct representation in accordance with the Fischer projection, because vertical substituents are shown above the plane and horizontal substituents are shown below. This is in contrary to Fischer's convention. Therefore, the given structure is rotated in-plane by 90° or out-of-plane by 180° . These operations give the correct representation of the lactic acid according to the Fischer's convention. The structures (L), (Li) and (Lii) are identical configurations and represent the same isomer of the lactic acid.

The structure (f) is another way of representing three-dimensional form of a stereoisomer. It can also be easily transformed into Fischer projection in the way shown below.

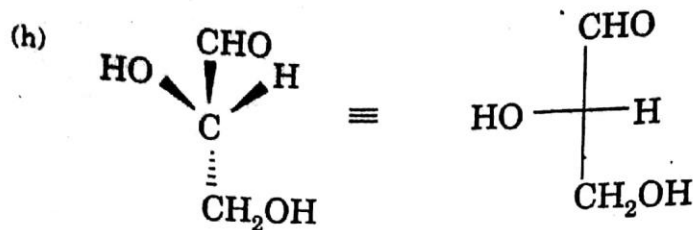

Fig. 2. 77

• **Flying wedge containing more than one chiral centre to Fisher projection and vice versa:**

Flying wedge structures of stereoisomers containing two stereocentres can similarly be converted into Fischer projection and *vice-versa*. A few examples are given below in Fig. 2.78 and 2.79.

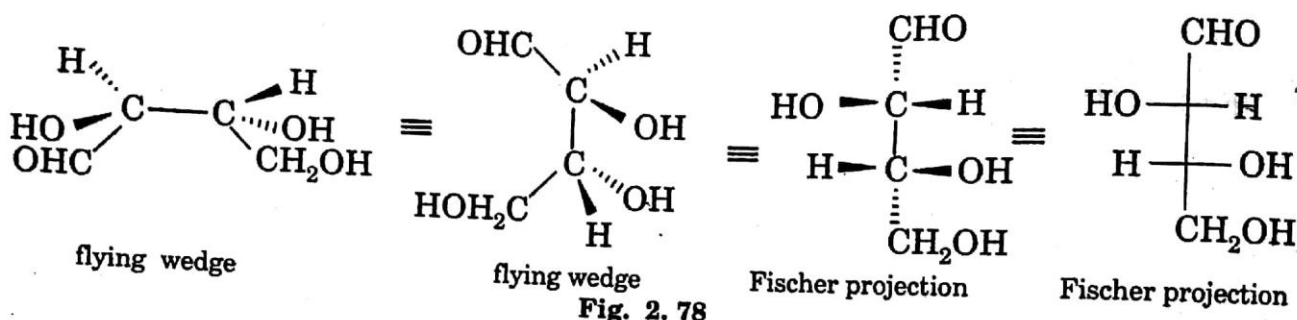

Fig. 2. 78

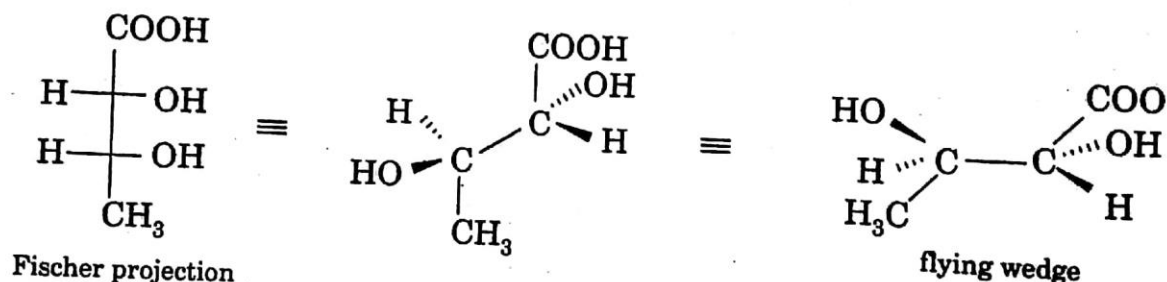
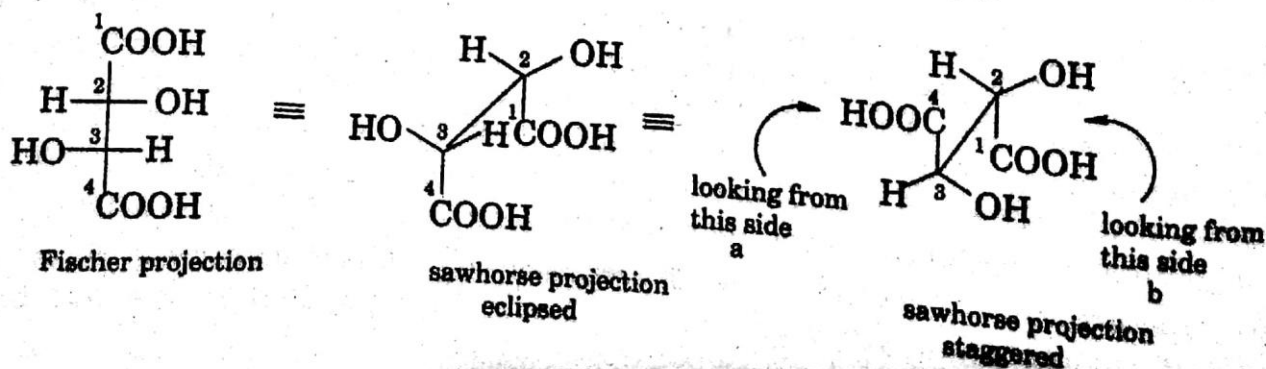

Fig. 2. 79

Fischer projection can be transformed into sawhorse form and then to flying wedge stereoisomer. An example is shown below (Fig. 2.80). It must be remembered that the same stereoisomer can be represented by eighteen different Fischer projections. In the example below, one Fischer projection of *threo*-tartaric acid (active) is first transformed into sawhorse form in eclipsed conformation and then converted into desired staggered form. The same structure can be written in other eclipsed and staggered forms also. Then the staggered form is transferred into flying wedge looking from two directions (a) and (b).



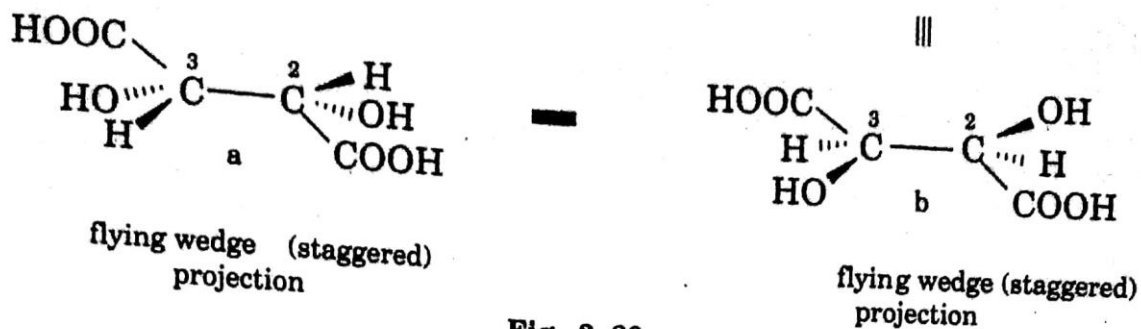

Fig. 2. 80

• **Zigzag form to Fischer Projection:**

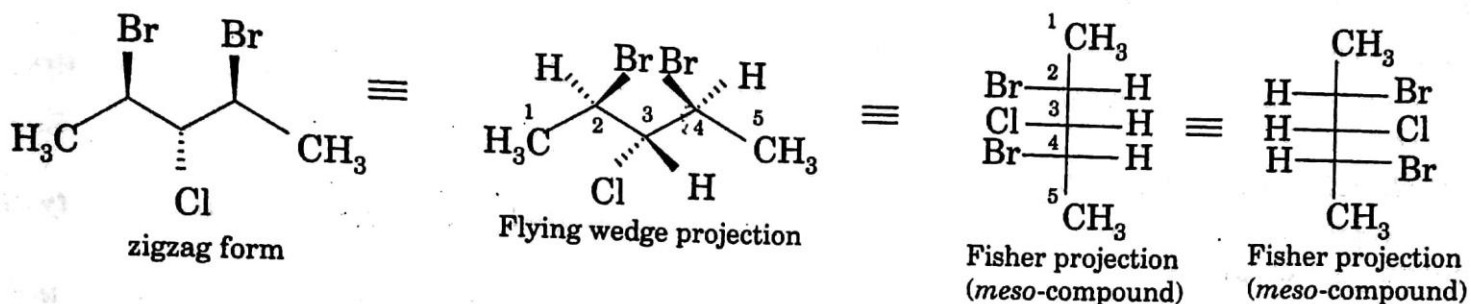
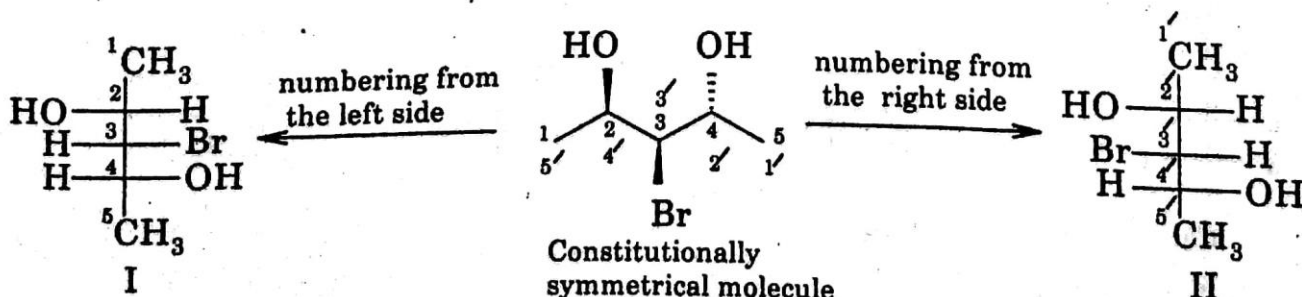

Fig. 2. 81

In the above zigzag structure, H atoms, according to convention, are not drawn. Therefore, zigzag form is first converted in to flying wedge projection by inserting H atoms above and below the plain of the carbon-backbone as the structure demands. It is then converted into Fisher projection by applying the technique discussed earlier

It is to be noted that in the above example, carbon-backbone is numbered from the left side and C-1 is placed at the top in the Fisher projection. Since the compound is symmetrical, the structure can also be numbered from the right side, when we can get the mirror-image Fisher projection of the previous Fisher projection of the same compound. However, in this particular case both are same *meso*-compound (superimposable). In case of a symmetrical molecule, numbering can be done from either end of the carbon chain leading to two apparently different Fischer projections but they are homomers. In unambiguous case numbering should follow IUPAC rules. Two more examples are given below for more illustrations.



I and II are homomers because one can be superimposed on the other by 180° in-plane rotation.

Substitution (SN2 , SN1) and Elimination Reactions (E2 , & E1):

- Nucleophilic Substitution Reactions (SN2 and SN1) replace a leaving group with a nucleophile (Nu: or Nu: -)
- Elimination Reactions (E2 and E1) generate a double bond by loss of " A+ " and " B: - "
- They may compete with each other

Nucleophilic Substitution Reactions - SN2 Reaction:

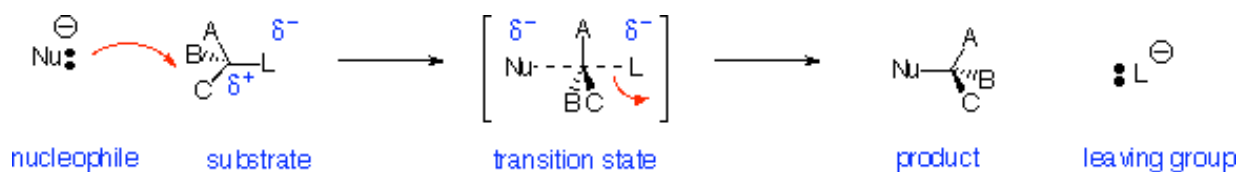

- **Reaction is:**
 - Stereospecific (Walden Inversion of configuration)
 - Concerted - all bonds form and break at same time
 - Bimolecular - rate depends on concentration of both nucleophile and substrate
 - **Substrate:**
 - Best if **primary** (one substituent on carbon bearing leaving group)
 - works if secondary, fails if tertiary
 - **Nucleophile:**
 - Best if more reactive (i.e. more anionic or more basic)
 - **Leaving Group:** Best if more stable (i.e. can support negative charge well):
 - TsO- (very good) > I- > Br- > Cl- > F- (poor)
 - RF , ROH , ROR , RNH₂ are NEVER Substrates for SN2 reactions
 - Leaving Groups on double-bonded carbons are never replaced by SN2 reactions
 - **Solvent:** Polar Aprotic (i.e. no OH) is best.
 - For example dimethylsulfoxide (CH₃SOCH₃), dimethylformamide (HCON(CH₃)₂), acetonitrile (CH₃CN).
 - Protic solvents (e.g. H₂O or ROH) deactivate nucleophile by hydrogen bonding but can be used in some case
-

Nucleophilic Substitution Reactions – SN1 Reaction:

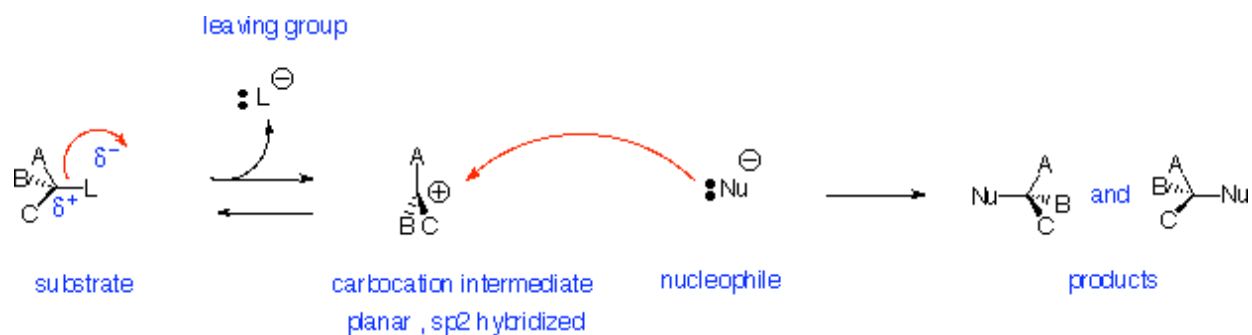

- **Reaction is:**
 - Non-stereospecific (attack by nucleophile occurs from both sides)
 - Non-concerted - has carbocation intermediate
 - Unimolecular - rate depends on concentration of only the substrate
 - **Substrate:**
 - Best if tertiary or conjugated (benzylic or allylic) carbocation can be formed as leaving group departs
 - never primary
 - **Nucleophile:**
 - Best if more reactive (i.e. more anionic or more basic)
 - **Leaving Group:**
 - Same as SN2
 - best if more stable (i.e. can support negative charge well)
 - Examples: TsO⁻ (very good) > I⁻ > Br⁻ > Cl⁻ > F⁻ (poor)
 - However, tertiary or allylic ROH or ROR' can be reactive under strongly acidic conditions to replace OH or OR
 - **Solvent:**
 - Same as SN2
 - Polar Aprotic (i.e. no OH) is best
 - Examples: dimethylsulfoxide (CH₃SOCH₃), dimethylformamide (HCON(CH₃)₂), acetonitrile (CH₃CN).
 - Protic solvents (e.g. H₂O or ROH) deactivate but can be used in some cases
-

Elimination Reactions - E2 Reaction:

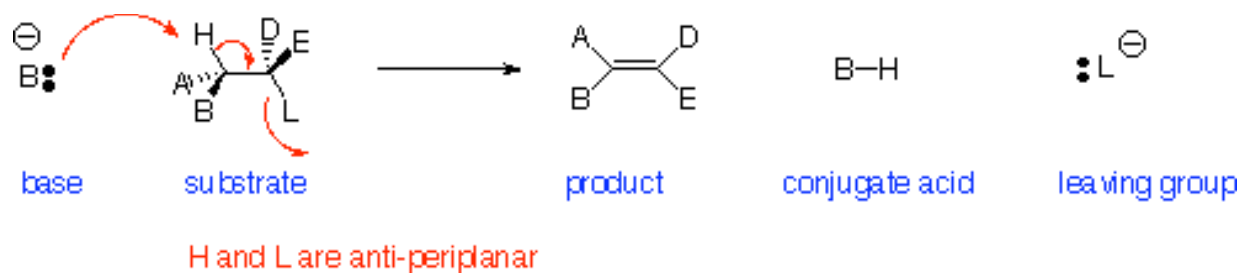

- **Reaction is:**
 - Stereospecific (Anti-periplanar geometry preferred, Syn-periplanar geometry possible)
 - Concerted - all bonds form and break at same time
 - Bimolecular - rate depends on concentration of both base and substrate
 - Favoured by strong bases

Elimination Reactions – E1 Reaction:

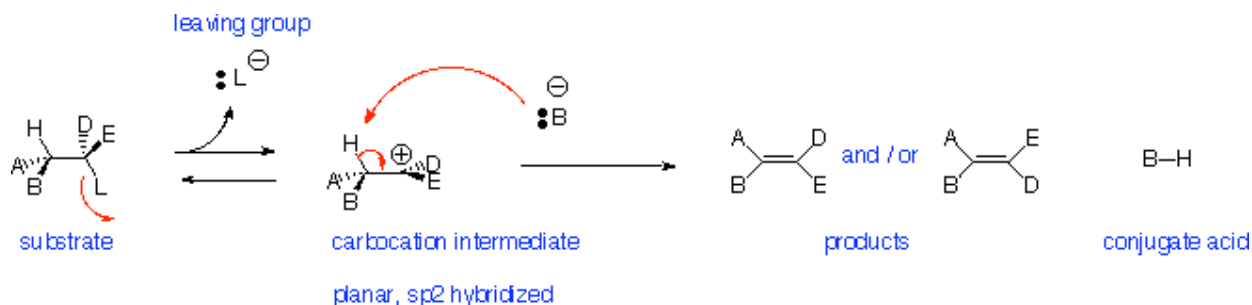

- **Reaction is:**
 - Non-stereospecific- follows Zaitsev (Saytseff) Rule
 - Non-concerted - has carbocation intermediate - favoured for tertiary leaving groups
 - Unimolecular - rate depends on concentration of only the substrate
 - Does NOT occur with primary alkyl halides (leaving groups)
 - Strong acid can promote loss of OH as H₂O or OR as HOR if tertiary or conjugated carbocation can be formed
-

Rearrangement reaction:

Types of Rearrangements

Rearrangements are divided into intramolecular and intermolecular processes. In intramolecular process, the group that migrates is not completely detached from the system in which rearrangement is taking place. In contrast, in intermolecular process, the migrating group is first detached and later re-attached at another site.

Rearrangement to Electron Deficient Carbon These reactions are classified according to the nature of group that migrates.

Carbon Migration

Wagner-Meerwein Rearrangement It is one of the simplest systems where an alkyl group migrates, with its bonding pair, to an electron-deficient carbon atom.

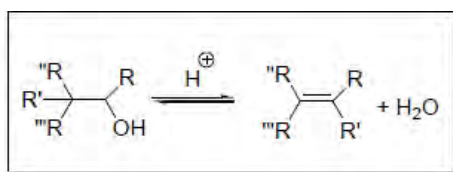

Mechanism

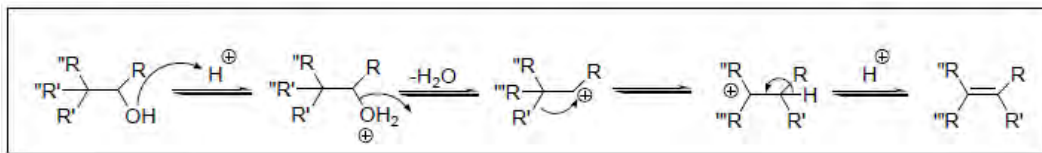

The driving force for the rearrangement resides in the greater stability of a tertiary carbocation compared to that of primary carbocation.

Features of this migration

- The carbocation may be produced by a variety of ways.
- Hydrogen can also migrate in this system.

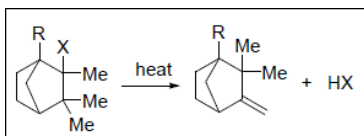

- Aryl groups have a greater migratory aptitude than alkyl group or hydrogen due to the formation of lower-energy bridged phenonium ion.

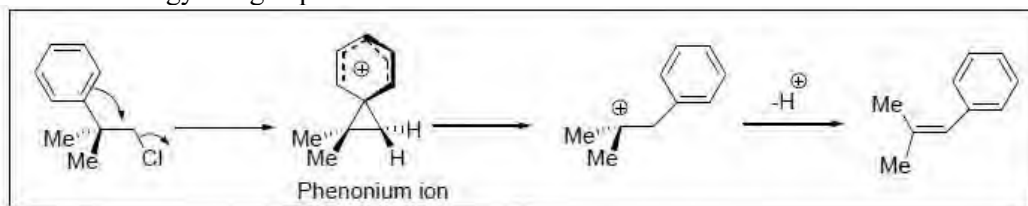

Pinacol Rearrangement

Treatment of 1,2-diols (pinacol) with acid lead to rearrangement to give ketone. Although this rearrangement fundamentally is similar to the above described Wagner-Meerwein rearrangement, but differs in that the rearranged ion, the conjugate acid of ketone, is relatively more stable than the rearranged carbocation formed in Wagner-Meerwein rearrangement. Thus, the driving force for pinacol is greater compared to Wagner-Meerwein rearrangement. However, the characteristics of the Wagner-Meerwein apply to the pinacol rearrangement.

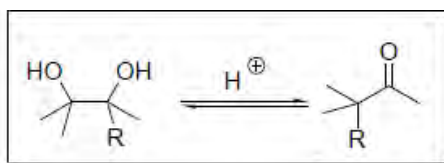

Mechanism

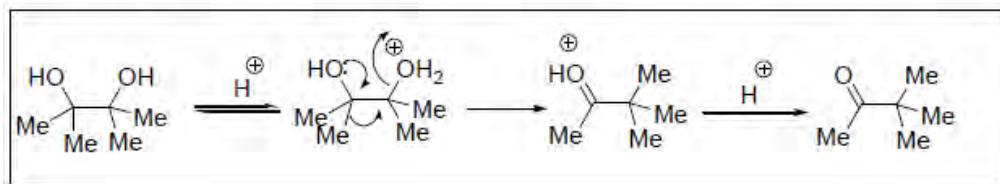

Hofmann Rearrangement This rearrangement provides an effective method for the synthesis of primary aliphatic and aromatic amines from primary amides (Scheme 1).

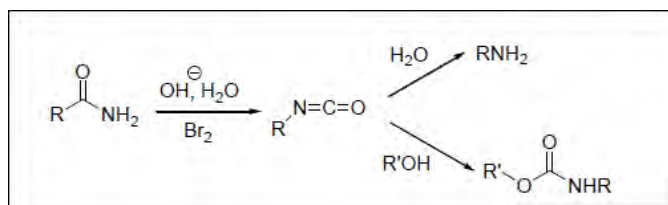

Mechanism Treatment of amide with sodium hypobromite gives *N*-bromo-amide which reacts with base to afford a conjugate base within which rearrangement takes place to give isocyanate. The formed isocyanate may be isolated in anhydrous conditions or it can be converted into amine by aqueous workup (Scheme 2).

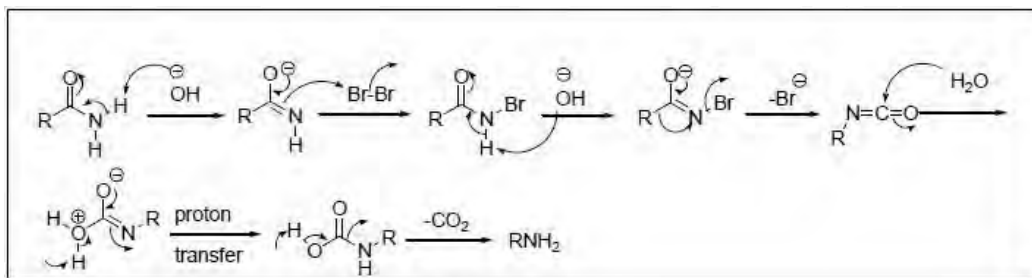

Scheme 2

Curtius Rearrangement This rearrangement describes the transformation of acyl azide into isocyanate by decomposition on heating and its application for the synthesis of primary amines, urethanes and ureas as presented in Hofmann rearrangement.

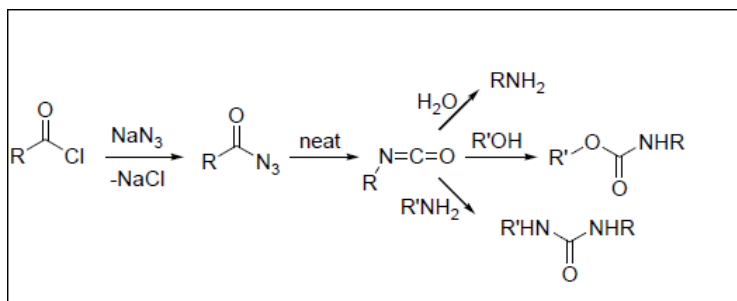

Mechanism

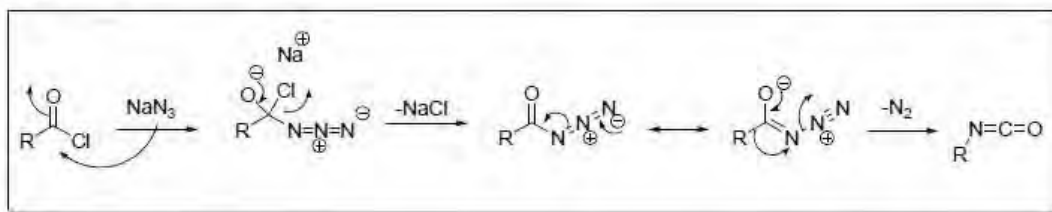

Lossen Rearrangement Ester of hydroxamic acid reacts with base to give isocyanate that could be converted into amine as shown in Hofmann rearrangement.

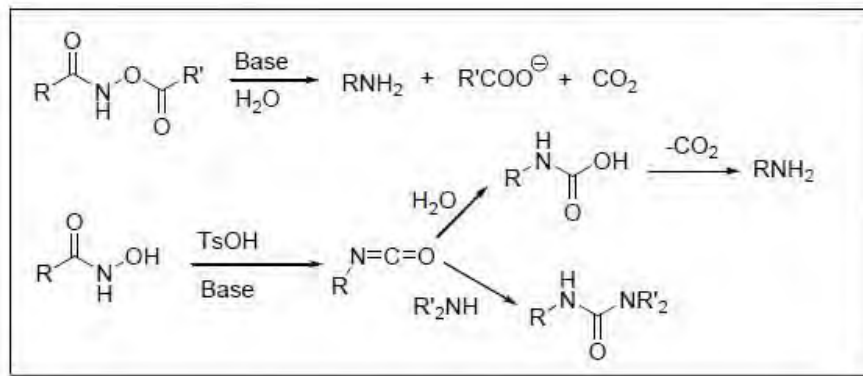

Mechanism

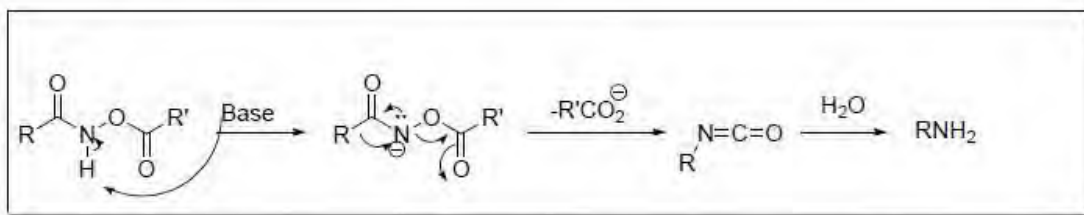

Module III: Kinetics and Catalysis:

Syllabus: Kinetics of Chain, Parallel/Competing/Side, Consecutive reactions; Fast reactions; Outline of Catalysis, Acid-base catalysis, Enzyme catalysis (Michaelis-Menten equation), Important catalysts in industrial processes: Hydrogenation using Wilkinsons catalyst, Phase transfer catalyst.

1. Introduction

- Chemical kinetics deals with the study of rate of chemical reactions. Rate of reaction is defined as change in concentration of reactants or products (or change in physical parameters which depends on the concentration such as conductance, absorbance, current etc.) per unit time.
- Besides information about the speed at which reactions occur, kinetics also sheds light on the reaction mechanism (exactly how the reaction occurs).
- Rate of the reaction is influenced by various factors such as nature of substance, physical state of substance, temperature, concentration (solution), pressure (gaseous reactions), surface area of the reactants, presence of catalyst, intensity of radiation etc.

2. Rate of reactions

$$\text{Rate of reaction} = \frac{\text{Change in the concentration of reactants or (products)}}{\text{Time}}$$

The rate of reaction is expressed in $\text{mol L}^{-1} \text{s}^{-1}$.

2.1 Average Rate of Reaction

Average rate of reaction is defined as change in the concentration of reactants (or products) during large interval of time. If ΔC is the change in the concentration of reactants and products in Δt time, then

$$\text{Average rate} = \frac{\text{Change in the concentration of reactants or (products)}}{\text{Time}} = \pm \frac{\Delta C}{\Delta t} = \pm \frac{C_2 - C_1}{t_2 - t_1}$$

The graph shows the progress of reaction with respect to time.

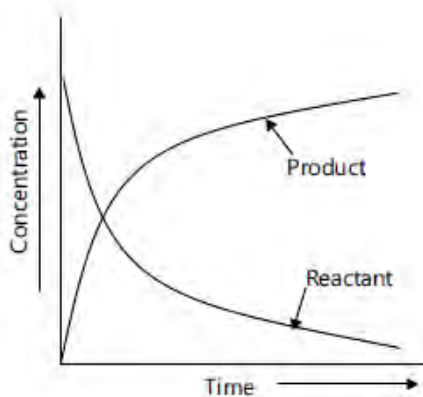

Concentration vs Time plot

2.2 Instantaneous Rate of Reaction

Instantaneous rate of reaction is defined as the reaction rate during a very short interval of time or rate of reaction at a particular time.

$$\text{Instantaneous rate} = \pm \lim_{\Delta t \rightarrow 0} \frac{\Delta C}{\Delta t} = \frac{dC}{dt} = \text{slope}$$

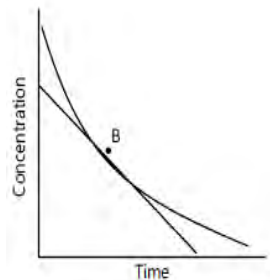

Instantaneous reaction

For the reaction $n_1A + n_2B \rightarrow m_1C + m_2D$

$$\text{Instantaneous rate of reaction} = -\frac{1}{n_1} \frac{d[A]}{dt} - \frac{1}{n_2} \frac{d[B]}{dt} = +\frac{1}{m_1} \frac{d[C]}{dt} = +\frac{1}{m_2} \frac{d[D]}{dt}$$

2.3 Expression of Rate of Reaction

For the following reaction $n_1A + n_2B \rightarrow m_1C + m_2D$

$$\text{Rate of reaction} = -\frac{1}{n_1} \frac{\Delta[A]}{\Delta t} - \frac{1}{n_2} \frac{\Delta[B]}{\Delta t} = +\frac{1}{m_1} \frac{\Delta[C]}{\Delta t} = +\frac{1}{m_2} \frac{\Delta[D]}{\Delta t}$$

For the reaction $2H_2O_2 \rightarrow 2H_2O + O_2$

$$\text{Rate of reaction} = \frac{\Delta[O_2]}{\Delta t} = -\frac{1}{2} \frac{\Delta[H_2O_2]}{\Delta t}$$

3. Rate Law

For the reaction: $mA + nB \rightarrow \text{product}$, the rate law is

$$\text{Rate} \propto [A]^m [B]^n$$

- It may not depend upon the concentration of each reactant or product of the reaction.
- Rate of chemical reaction is directly proportional to the concentration of reactants.
- The rate law represents the experimentally observed rate of reaction, which depends upon the slowest step of the reaction.
- Rate law cannot be deduced from the equation for a given reaction. It can be found out by experiments only.
- The rate law may not bear a simple relationship for the stoichiometric equation.
- It may not depend upon the concentration of species, which do not appear in the equation for the overall reaction.

4. Rate Constant

Consider a simple reaction $A \rightarrow B$

At a particular instant, if C_A is the molar concentration or active mass of A, then

$$\frac{dX}{dt} \propto C_A \text{ or } \frac{dX}{dt} = kC_A$$

where k is a proportionality constant, called velocity constant or rate constant or specific reaction rate.

At a fixed temperature, if $C_A = 1$, then $\text{Rate} = \frac{dX}{dt} = k$

Thus, rate constant can be defined as rate of reaction at unit concentration of the reactants.

Units of Rate Constant

For reactions of different order, unit for rate constant is as follows:

$$\begin{aligned} \text{Unit of rate constant} &= \left[\frac{1}{\text{Unit of concentration}} \right]^{n-1} \times \text{time}^{-1} \\ &= \left[\frac{1}{\text{mole/litre}} \right]^{n-1} \times \text{sec}^{-1} = \left\{ \left[\frac{\text{litre}}{\text{mol}} \right]^{n-1} \times \text{sec}^{-1} \right\} \end{aligned}$$

Where n is the order of the reaction.

5. Order of Reaction

The order of any reaction may be defined as the sum of the powers to which the concentration terms are raised in order to determine the rate of reaction.

For the reaction: $mA+nB \rightarrow \text{product}$

The experimental data suggests that

Rate = $k[A]^p[B]^q$; then the order with respect to A = p and the order with respect to B = q and the total order of the reaction $n = p + q$.

Note: n can be (-) ve, 0, fraction, integers.

A summary of reactions with the differential and integrated equations.

	Zero-Order	First-Order	Second-Order	n th -Order
Rate Law (differential)	$-\frac{d[A]}{dt} = k$	$-\frac{d[A]}{dt} = k[A]$	$-\frac{d[A]}{dt} = k[A]^2$	$-\frac{d[A]}{dt} = k[A]^n$
Integrated Rate Law	$[A] = [A]_0 - kt$	$[A] = [A]_0 e^{-kt}$	$\frac{1}{[A]} = \frac{1}{[A]_0} + kt$	$\frac{1}{[A]^{n-1}} = \frac{1}{[A]_0^{n-1}} + (n-1)kt$ [Except first order]
Units of Rate Constant (k)	$\frac{M}{s}$	$\frac{1}{s}$	$\frac{1}{M \cdot s}$	$\frac{1}{M^{n-1} \cdot s}$
Linear Plot to determine k	$[A]$ vs. t	$\ln([A])$ vs. t	$\frac{1}{[A]}$ vs. t	$\frac{1}{[A]^{n-1}}$ vs. t [Except first order]
Half-life	$t_{1/2} = \frac{[A]_0}{2k}$	$t_{1/2} = \frac{\ln(2)}{k}$	$t_{1/2} = \frac{1}{k[A]_0}$	$t_{1/2} = \frac{2^{n-1} - 1}{(n-1)k[A]_0^{n-1}}$ [Except first order] n ≥ 2

7. Kinetics of some complex reactions: Chain, Parallel/Competing/Side, Consecutive reactions

7.1. Kinetics of Chain reactions

Chain reactions usually involve free radicals. We will show how to deal with chain reactions by working out several examples. Our first example is the gas phase reaction of hydrogen with bromine to give HBr. (The temperature must be high enough that bromine is a gas and not a liquid.)



The experimental rate law is obtained by Linde and Bodenstein

$$\frac{d[\text{HBr}]}{dt} = \frac{k'[\text{H}_2][\text{Br}_2]^{1/2}}{1 + k''\frac{[\text{HBr}]}{[\text{Br}_2]}} \quad (2)$$

Our task is to show that the postulated mechanism will give this rate law. (We will not try to invent mechanisms for particular reactions in this course.) The postulated mechanism has five elementary reaction steps:

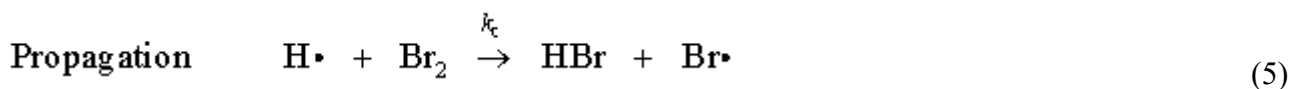
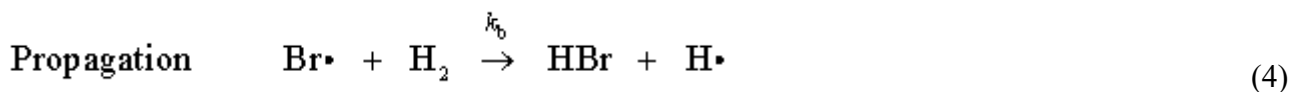

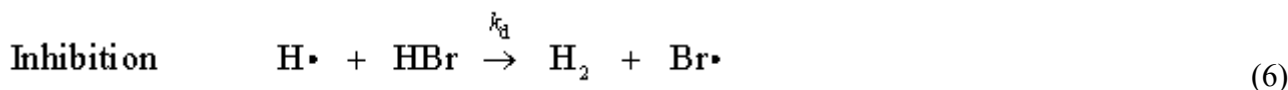

Our goal is to find the rate law implied by this mechanism and see how it compares to the experimental rate law, Equation 2. Our first task will be to define the reaction rate. We will define the reaction rate as rate of production of the product, HBr.

$$\text{Rate} = \frac{d[\text{HBr}]}{dt} \quad (8)$$

Looking at the mechanism and using only the steps which yield or consume HBr we find that

$$\frac{d[\text{HBr}]}{dt} = k_b[\text{Br}\cdot][\text{H}_2] + k_c[\text{H}\cdot][\text{Br}_2] - k_d[\text{H}\cdot][\text{HBr}]. \quad (9)$$

We see that the rate contains two transient species, Br• and H•, so we set up the equations which show the rate of change of the concentrations of these two species and apply the steady state approximation. The two equations are,

$$\frac{d[\text{H}\cdot]}{dt} = k_b[\text{Br}\cdot][\text{H}_2] - k_c[\text{H}\cdot][\text{Br}_2] - k_d[\text{H}\cdot][\text{HBr}] \approx 0 \quad (10)$$

and

$$\frac{d[\text{Br}\cdot]}{dt} = 2k_a[\text{Br}_2] + \{-k_b[\text{Br}\cdot][\text{H}_2] + k_c[\text{H}\cdot][\text{Br}_2] + k_d[\text{H}\cdot][\text{HBr}]\} - 2k_e[\text{Br}\cdot]^2 \approx 0. \quad (11)$$

In Equation 11 we have set three of the terms apart by braces { } in order to make it easier to see that the part inside the braces is just the negative of the middle of Equation 10. Since the part inside the braces is zero we conclude that

$$2k_a[\text{Br}_2] - 2k_e[\text{Br}\cdot]^2 = 0, \quad (12)$$

or

$$[\text{Br}\cdot] = \sqrt{\frac{k_a}{k_e}} [\text{Br}_2]. \quad (13)$$

We can solve Equation 10 for [H•] to get

$$[\text{H}\cdot] = \frac{k_b[\text{Br}\cdot][\text{H}_2]}{k_c[\text{Br}_2] + k_d[\text{HBr}]}, \quad (14)$$

which, on substituting the result of Equation 13, becomes,

$$[\text{H}\cdot] = \frac{k_b[\text{H}_2] \sqrt{\frac{k_a}{k_e}} [\text{Br}_2]}{k_c[\text{Br}_2] + k_d[\text{HBr}]}. \quad (15)$$

We now go back to the equation for the Rate, Equation 9, and note that the right hand side of Equation 9 is the same as Equation 10 except for the sign of the k_c term. Rewrite Equation 10 as,

$$k_b[\text{Br}\cdot][\text{H}_2] - k_c[\text{H}\cdot][\text{Br}_2] - k_d[\text{H}\cdot][\text{HBr}] = 0, \quad (10b)$$

or

$$k_b[\text{Br}\cdot][\text{H}_2] - k_d[\text{H}\cdot][\text{HBr}] = k_c[\text{H}\cdot][\text{Br}_2]. \quad (10c)$$

Combining Equations 9 and 10c we find that,

$$\frac{d[\text{HBr}]}{dt} = 2k_c[\text{H}\cdot][\text{Br}_2]. \quad (16)$$

Since Equation 15 gives us an expression for $[\text{H}\cdot]$ we can combine Equations 15 and 16 to eliminate all the transient concentrations,

$$\frac{d[\text{HBr}]}{dt} = 2k_c \frac{k_b[\text{H}_2] \sqrt{\frac{k_a}{k_e} [\text{Br}_2]}}{k_c[\text{Br}_2] + k_d[\text{HBr}]} [\text{Br}_2], \quad (17)$$

which rearranges to

$$\frac{d[\text{HBr}]}{dt} = \frac{2k_b \sqrt{\frac{k_a}{k_e}} [\text{H}_2] [\text{Br}_2]^{1/2}}{1 + \frac{k_d [\text{HBr}]}{k_c [\text{Br}_2]}}. \quad (18)$$

with,

$$k' = 2k_b \sqrt{\frac{k_a}{k_e}} \quad (19)$$

and

$$k'' = \frac{k_d}{k_c}. \quad (20)$$

Equation 18 has the same form as Equation 2

$$\frac{d[\text{HBr}]}{dt} = \frac{k'[\text{H}_2][\text{Br}_2]^{1/2}}{1 + k'' \frac{[\text{HBr}]}{[\text{Br}_2]}}.$$

The two phenomenological rate constants, k' and k'' , can be written in terms of the rate constants for the elementary reaction steps in the mechanism.

In the initial stage of the reaction, i.e., $t = 0$, $[\text{HBr}]$ is negligibly small i.e., $[\text{HBr}] = 0$ and hence

$$1 + k'' [\text{HBr}]/[\text{Br}_2] \approx 1$$

And the initial rate becomes $\frac{d[\text{HBr}]}{dt} = k'[\text{H}_2][\text{Br}_2]^{1/2}$

That is, in the initial stage, the overall order of the reaction is 1.5 (order 1 w.r.t. H_2 and $\frac{1}{2}$ w.r.t. Br_2).

7.1. Kinetics of consecutive or sequential reactions

In many cases, the product formed in one of the elementary reactions acts as the reactant for some other elementary reaction. One of the examples of consecutive reactions involves the following steps.

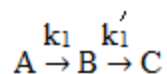

Let the initial concentration of A be $[A]_0$ and let after time t , the concentrations of A, B and C be $[A]$, $[B]$ and $[C]$, respectively. It is obvious that

$$[A]_0 = [A] + [B] + [C] \quad (1)$$

Differential Rate Law: The differential rate expressions are

$$-\frac{d[A]}{dt} = k_1[A] \quad \dots\dots(2)$$

$$\frac{d[B]}{dt} = k_1[A] - k_1'[B] \quad \dots\dots(3)$$

$$\frac{d[C]}{dt} = k_1'[B] \quad \dots\dots(4)$$

On integrating equation (2), we get

$$[A] = [A]_0 e^{-k_1 t} \quad \dots\dots(5)$$

Substituting $[A]$ from equation (5) into equation (3), we get

$$\frac{d[B]}{dt} = k_1[A]_0 e^{-k_1 t} - k_1'[B]$$

$$\frac{d[B]}{dt} + k_1'[B] = k_1[A]_0 e^{-k_1 t}$$

Integrated Rate Law : Multiplying the above expression throughout by $\exp (k_1' t)$, we get

$$\frac{d[B]}{dt} + k_1'[B]e^{k_1't} = k_1[A]_0 e^{-(k_1-k_1')t}$$

The left side of the above expression is equal to $d([B]e^{k_1't})/dt$. Hence, the above expression can be written as , $d\{[B]e^{k_1't}\} = k_1[A]_0 e^{-(k_1-k_1')t} dt$

Integrating the above expression with $[B] = 0$ at $t = 0$, we get

$$[B]e^{k_1't} = k_1[A]_0 \left[\frac{e^{-(k_1-k_1')t}}{-(k_1-k_1')} + \frac{1}{k_1-k_1'} \right]$$

$$[B] = k_1[A]_0 \left[\frac{e^{-k_1t}}{-(k_1'-k_1)} + \frac{e^{-k_1't}}{k_1-k_1'} \right]$$

$$[B] = k_1[A]_0 \left(\frac{k_1}{k_1'-k_1} \right) \{e^{-k_1t} - e^{-k_1't}\} \quad \dots\dots(6)$$

Substituting equations (5) and (6) in equation (1), we get

$$[A]_0 = [A]_0 e^{-k_1t} + [A]_0 \left(\frac{k_1}{k_1'-k_1} \right) (e^{-k_1t} - e^{-k_1't}) + [C]$$

$$[C] = [A]_0 \left[1 - \frac{1}{k_1'-k_1} (k_1'e^{-k_1't} - k_1e^{-k_1t}) \right] \quad \dots\dots(7)$$

Figure (1) Illustrates the general appearance of the variations of concentrations of A, B and C during the progress of the reaction.

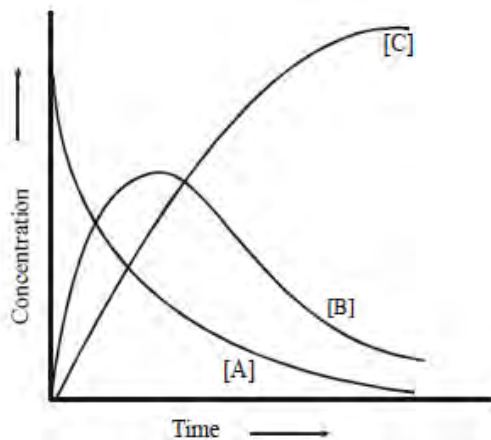

Fig. Typical variations of concentration of A, B and C during the progress of the reaction $A \rightarrow B \rightarrow C$. The actual variations on the values of k_1 and k_1' .

In general concentration of A decreases exponentially, the concentration of B initially increases up to a maximum and then decreases thereafter, and the concentration of C increases steadily until it reaches its final value $[A]_0$, when all A has changed into C.

Maximum Concentration of B : Equation (6) is

$$[B] = [A]_0 \left(\frac{k_1}{k'_1 - k_1} \right) \{ e^{-k_1 t} - e^{-k'_1 t} \} \quad \dots\dots(6)$$

At the maximum concentration of B, we have

$$\frac{d[B]}{dt} = 0$$

Hence, differentiating equation (6) with respect to t, we get

$$\frac{d[B]}{dt} = [A]_0 \left(\frac{k_1}{k'_1 - k_1} \right) \{ -k_1 e^{-k_1 t} + k'_1 e^{-k'_1 t} \} \quad \dots\dots(8)$$

Equating equation (8) to zero, we get

$$-k_1 e^{-k_1 t_{\max}} + k'_1 e^{-k'_1 t_{\max}} = 0$$

or $\frac{k_1}{k'_1} = e^{(k_1 - k'_1) t_{\max}}$

or $\ln \left(\frac{k_1}{k'_1} \right) = (k_1 - k'_1) t_{\max}$

or $t_{\max} = \frac{1}{k_1 - k'_1} \ln \left(\frac{k_1}{k'_1} \right) \quad \dots\dots(9)$

substituting equation (9) in equation (6), we get

$$[B]_{\max} = [A]_0 \left(\frac{k'_1}{k_1} \right)^{k'_1 / (k_1 - k'_1)} \quad \dots\dots(10)$$

Examples of 1st order consecutive reactions:

- Radioactive decay
- Decomposition of dimethyl ether in gaseous phase and that of the ethylene oxide. The reactions are

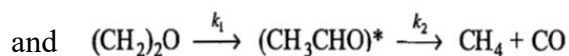
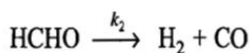
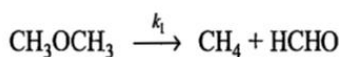

Important conclusions from equations (5), (6) and (7):

Two important conclusions are (1) the slowest elementary process (i.e. the process having smallest rate constant) is the rate-determining step of the reaction and (2) the steady-state approximation (the reactive intermediate are present in constant concentration) can be assumed to hold good for all reactive intermediates. These conclusions can be derived as follows.

(i) Rate-determining step: In the consecutive reactions

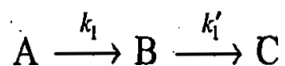

the reaction rate constant $k'_1 \gg k_1$ i.e. reaction $A \rightarrow B$ is much slower than the reaction $B \rightarrow C$. Thus the rate of formation of the product C depends wholly on the rate at which the intermediate B is formed from A. The same conclusion can be derived from the equation (7). We have

$$[C] = [A]_0 \left\{ 1 - \frac{1}{k'_1 - k_1} (k'_1 e^{-k_1 t} - k_1 e^{-k'_1 t}) \right\}$$

Since $k'_1 \gg k_1$, the $e^{-k'_1 t}$ will be much smaller than $e^{-k_1 t}$ and hence $k_1 e^{-k_1 t}$ may be ignored in comparison to $k'_1 e^{-k'_1 t}$.

Hence, the above equation simplifies to

$$[C] \approx [A]_0 \left\{ 1 - \frac{k'_1}{k'_1 - k_1} e^{-k_1 t} \right\}$$

Since k_1 is much smaller than k'_1 , we may ignore k_1 in comparison to k'_1 . Thus, the above equation becomes

$$[C] \approx [A]_0 (1 - e^{-k_1 t}) \tag{11}$$

Equation (11) can be obtained directly if we consider alone the reaction $A \rightarrow C$

$$\text{Now } \frac{d[C]}{dt} = k_1[A] = k_1([A]_0 - [C])$$

$$\text{or } \frac{d[C]}{[A]_0 - [C]} = k_1 dt$$

$$\text{or } \int_0^{[C]} \frac{d[C]}{[A]_0 - [C]} = k_1 \int_0^t dt$$

$$\text{or } \ln \frac{[A]_0 - [C]}{[A]_0} = -k_1 t$$

$$\text{or } \frac{[A]_0 - [C]}{[A]_0} = e^{-k_1 t}$$

$$\text{Hence } [C] = [A]_0 (1 - e^{-k_1 t})$$

This is identical to equation (11). Thus we may conclude that the reaction with the smaller rate constant is the rate-determining step.

The same conclusion would be obtained if we consider the 1st step is much faster than 2nd step, i.e.

$k_1 \gg k'_1$. In this case we will ignore k'_1 in comparison to k_1 and $k'_1 e^{-k'_1 t}$ in comparison to $k_1 e^{-k_1 t}$

Hence, equation (7) in the present case will simplify to

$$[C] = [A]_0 (1 - e^{-k_1 t})$$

The above equation can be obtained directly if we consider alone the reaction



With $[B]_0 = [A]_0$ as the transformation of A to B is very fast.

(ii) Steady-state approximation: The typical variation of concentration of A, B and C for the two consecutive 1st order reactions

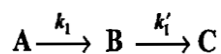

with (a) $k_1 \gg k'_1$ and (b) $k_1 \ll k'_1$, respectively

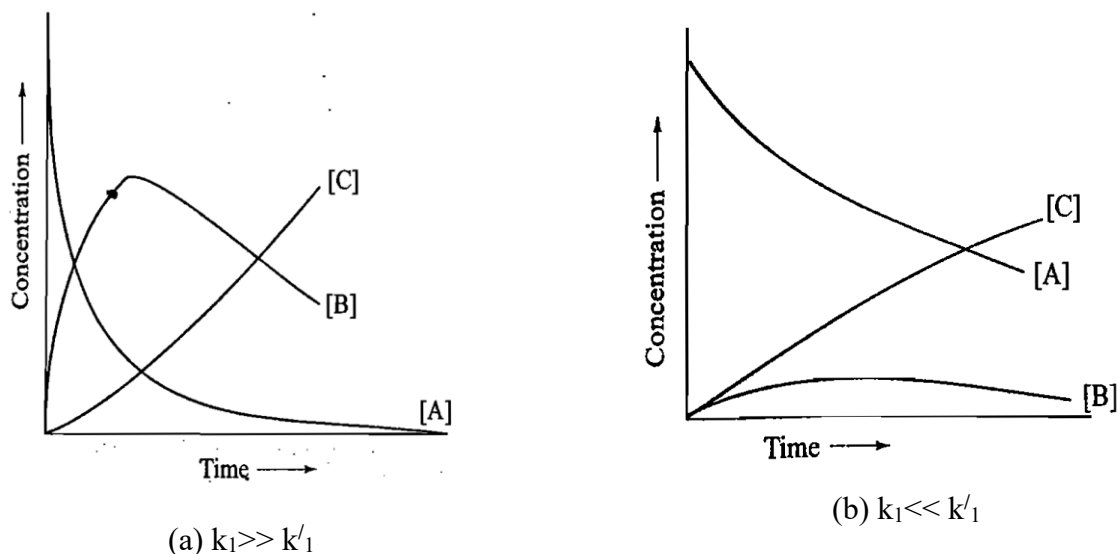

Fig. Variation of concentration of A, B and C for the two consecutive 1st order reactions with (a) $k_1 \gg k'_1$ and (b) $k_1 \ll k'_1$.

In Fig. 2(a), the concentration of A disappears very rapidly as $k_1 \gg k'_1$ and since the rate at which B disappears is relatively slow, the concentration of B increases rapidly and after attaining the maximum in a small time interval, starts decreasing.

In Fig. 2(b), the concentration of A decreases slowly as the reaction rate constant k_1 has a small value. The concentration of B practically remains constant for reasonable time, except at very beginning and at the end. This constancy results from the fact that the intermediate B is very reactive as its transformation to C occurs at very fast rate. In fact, the concentration of B at any instant will be much smaller than that of A.

From equation (6)

$$[B] = [A]_0 \left(\frac{k_1}{k'_1 - k_1} \right) \{ e^{-k_1 t} - e^{-k'_1 t} \}$$

on ignoring k_1 in comparison to k'_1 and $e^{-k'_1 t}$ comparison to $e^{-k_1 t}$, we get

$$[B] \approx [A]_0 \frac{k_1}{k'_1} e^{-k_1 t} \quad (12)$$

Since at any instant the concentration of A is given by equation (5), we get

$$[B] \approx \frac{k_1}{k'_1} [A] \quad (13)$$

That is, the concentration of B is smaller than the concentration of A by a factor of about (k_1/k'_1) . The concentration of the reactive intermediate B has a small value and that it practically remains constant throughout the reaction is known as the *steady-state approximation*. Mathematically, it can be written as

$$\frac{d[B]}{dt} = 0 \quad (14)$$

The use of this equation very much simplifies the kinetics of the reaction. For example, in a consecutive 1st order reaction with $k'_1 \gg k_1$, equation (3) gives

$$\begin{aligned} \frac{d[B]}{dt} &= k_1[A] - k'_1[B] = 0 \\ \text{or } [B] &= \frac{k_1}{k'_1} [A] \end{aligned} \quad (15)$$

Substituting the above equation in equation (4), we get

$$\frac{d[C]}{dt} = k'_1[B] = k'_1 \frac{k_1}{k'_1} [A] = k_1[A] \quad (16)$$

Note the identity of equations (13 & 15) and equations (10 & 16).

7.2. Kinetics of Parallel / Side/ Competing Reactions:

Consider the reaction

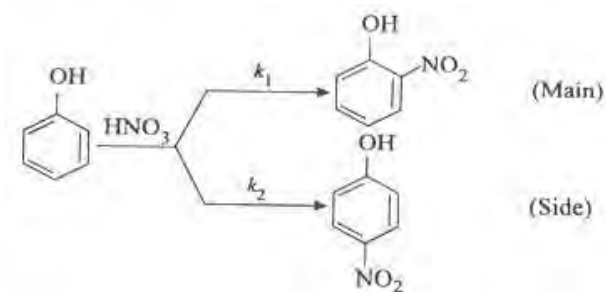
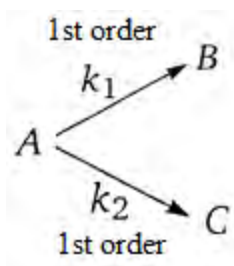

The differential rate expressions are

$$\frac{d[B]}{dt} = +k_1[A] \quad (1)$$

$$\frac{d[C]}{dt} = +k_2[A] \quad (2)$$

The overall reaction rate for the consumption of A can be written as:

$$\frac{d[A]}{dt} = -k_1[A] - k_2[A]$$

Or

$$\frac{d[A]}{dt} = -(k_1 + k_2)[A] \quad (3)$$

We can solve for the concentrations of A, B and C at any time 't'. To solve for [B] or [C], we must know [A].

Integrating $[A]$ with respect to t , we obtain the following equation:

$$[A] = [A]_0 e^{-(k_1+k_2)t}$$

Plugging this expression into the equation for $\frac{d[B]}{dt}$, we obtain:

$$\frac{d[B]}{dt} = k_1[A] = k_1[A]_0 e^{-(k_1+k_2)t}$$

Integrating $[B]$ with respect to t , we obtain:

$$[B] = -\frac{k_1[A]_0}{k_1+k_2} \left(e^{-(k_1+k_2)t} \right) + c_1$$

At $t = 0$, $[B] = 0$. Therefore,

$$c_1 = \frac{k_1[A]_0}{k_1+k_2}$$

$$[B] = \frac{k_1[A]_0}{k_1+k_2} \left(1 - e^{-(k_1+k_2)t} \right)$$

Likewise,

$$[C] = \frac{k_2[A]_0}{k_1+k_2} \left(1 - e^{-(k_1+k_2)t} \right)$$

The ratio of $[B]$ to $[C]$ is simply:

$$\frac{[B]}{[C]} = \frac{k_1}{k_2}$$

The ratio of concentrations of B and C at any time is constant.

Concentration vs Time Plot:

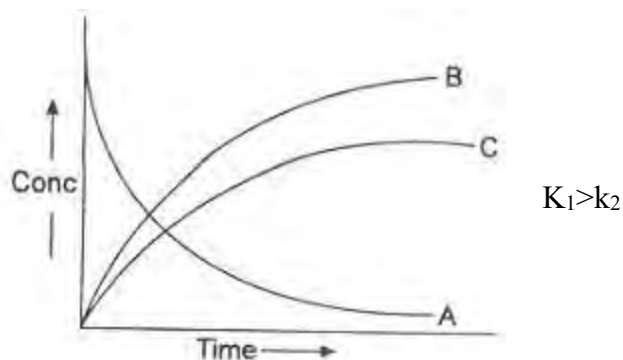

The Effective Half-life:

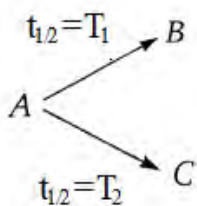

For 1st order reaction, $t_{1/2} = \frac{\ln 2}{k}$

Hence, $T_1 = \frac{\ln 2}{k_1}$

$$T_2 = \frac{\ln 2}{k_2}$$

Therefore, effective half-life

$$T_{eff} = \frac{\ln 2}{k_{eff}}$$

$$k_{eff} = \frac{\ln 2}{T_{eff}}$$

Since, $k_{eff} = k_1 + k_2$

$$\frac{\ln 2}{T_{eff}} = \frac{\ln 2}{T_1} + \frac{\ln 2}{T_2}$$

$$\frac{1}{T_{eff}} = \frac{1}{T_1} + \frac{1}{T_2}$$

Thermodynamic vs Kinetic control product:



Consider the reverse reactions



Moreover $B \leftrightarrow C$

At equilibrium $\frac{K_1}{K_2} = \left\{ \frac{[B]/[A]}{[C]/[A]} \right\} = \frac{[B]}{[C]}$ **Thermodynamic control**
K=Eqbm. Const.

When any reverse reactions or interconversion of B and C can be neglected $\frac{[C]}{[D]} = \frac{k_1}{k_2}$ **Kinetic control**
k=Rate Const.

8. Methods to Study Kinetics of Fast Reactions:

The chemical reaction which completes in less than 1 ps (one picosecond) (10⁻¹² s) time, is known as the fast reactions. It is practically impossible to measure the speed of such reactions. The reason for a very fast rate of such reaction is that no chemical bonds are to be broken among the reactants.

Examples: ionic reactions, organic substitution reactions, neutralization reactions

Characteristics of Fast Reactions

- The chemical reactions in which the rate constant lies between 10¹ – 10¹¹ s⁻¹ are called fast reactions. They have very short half-life of 10⁻¹ – 10⁻¹⁵ s.
- They are so fast that they occur as soon as the reactants are brought together.
- The special experimental techniques used for measuring the rate constant of fast reactions include: Relaxation methods, Flow methods, Ultrasonic and Resonance techniques etc.

Relaxation Methods:

Relaxation methods are classified into three groups based on the extent of perturbation to attain a new equilibrium. They include:

- Small perturbation method
Examples: Temperature jump method and Pressure jump method
- Large perturbation method
Examples: Shock tube method and Flash photolysis
- Periodic perturbation method
Example: Ultrasonic method

- In relaxation techniques, a chemical equilibrium is disturbed (perturbed) by a rapid change in one of the possible parameters like temperature or pressure or electric field intensity.
- The relaxation is followed by using spectrometer or conductivity meter techniques.
- The time during which the reaction gets relaxed from the equilibrium is called relaxation time.
- The relaxation time can be determined by T-jump method or by P-jump method.

Relaxation by Temperature Jump Method (T-Jump Method):

- In T-jump method, a high voltage power supply charges the capacitor (C).
- When a certain voltage is reached, the spark gap (G) breaks down and thereby discharging the capacitor and sending a strong current through the cell containing reactive system at equilibrium (Fig. 3).
- As the current passes, the temperature of the reactive system rises by about 10°C in few microseconds. This temperature rise perturbs the system in such a way that the concentration of reactive species adjusts to a new equilibrium value.
- The speed with which the system approaches new equilibrium is monitored through spectrometer in which the intensity of light leaving the cell is measured by using a suitable photodetector (Photo multiplier tube-PMT).
- The output of PMT is displayed as the variation of concentration versus time on the oscilloscope screen.

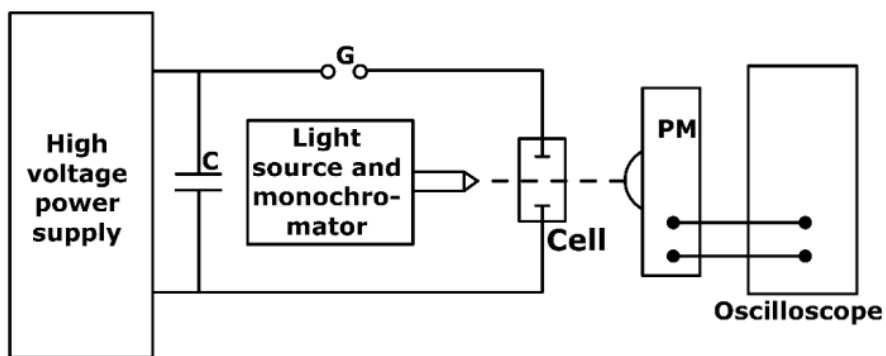
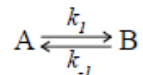

Fig. Apparatus for the temperature jump method

Rate Constant Expression for Fast Reactions by T-Jump Method:

If the displacement from equilibrium is very small, the rate of relaxation (restoration of equilibrium) always follows the first order kinetics.

Consider a reversible first- order reaction:



Let 'a' be the total concentration of A, and 'x' be the concentration of B at any interval of time 't'.

Therefore, the rate of reaction is given by:

$$\frac{dx}{dt} = k_1(a - x) - k_{-1}x \quad \dots (1)$$

At equilibrium $dx/dt = 0$ and $x = x_e$, and from the equation (1) we have:

$$0 = k_1(a - x_e) - k_{-1}x_e \quad \dots (2)$$

(or)

$$k_1(a - x_e) = k_{-1}x_e \quad \dots (3)$$

The deviation from equilibrium (Δx) may be defined as:

$$\Delta x = x - x_e$$

Where x_e is equilibrium concentration.

(or)

$$x = \Delta x + x_e \quad \dots (4)$$

The deviation of Δx with time is given by:

$$\frac{d(\Delta x)}{dt} = k_1(a - x) - k_{-1}x$$

But $x = \Delta x + x_e$ and hence, we have:

$$\frac{d(\Delta x)}{dt} = k_1[a - \Delta x - x_e] - k_{-1}[\Delta x + x_e] \quad \dots (5)$$

$$\frac{d(\Delta x)}{dt} = k_1a - k_1\Delta x - k_1x_e - k_{-1}\Delta x - k_{-1}x_e$$

$$\frac{d(\Delta x)}{dt} = k_1(a - x_e) - k_1\Delta x - k_{-1}\Delta x - k_{-1}x_e$$

$$\frac{d(\Delta x)}{dt} = k_1(a - x_e) - k_1\Delta x - k_{-1}\Delta x - k_{-1}x_e \quad \dots (6)$$

From equation (3), we have:

$$k_1(a - x_e) = k_{-1}x_e$$

Therefore, the equation (6) is written as:

$$\frac{d(\Delta x)}{dt} = k_{-1}x_e - k_1\Delta x - k_{-1}\Delta x - k_{-1}x_e$$

(or)

$$\frac{d(\Delta x)}{dt} = -\Delta x[k_1 + k_{-1}]$$

$$\frac{d(\Delta x)}{dt} = -\Delta x \cdot k_r \quad \dots (7)$$

Where $k_r = [k_1 + k_{-1}]$ is known as relaxation constant.

The reciprocal of relaxation constant is known as relaxation time (τ^).*

$$\tau^* = \frac{1}{k_r} = \frac{1}{[k_1 + k_{-1}]}$$

Rearranging equation (7), we have:

$$\frac{d(\Delta x)}{\Delta x} = -k_r dt \quad \dots (8)$$

Since the quantity Δx varies with time, integrating the equation (8) subjected to the boundary conditions $\Delta x = \Delta x_o \rightarrow \Delta x$ when $t = 0 \rightarrow t$, we have:

$$\int_{\Delta x = \Delta x_o}^{\Delta x = \Delta x} \frac{d(\Delta x)}{\Delta x} = -k_r \int_{t=0}^{t=t} dt$$

$$\ln \frac{\Delta x}{\Delta x_o} = -k_r t$$

$$\frac{\Delta x}{\Delta x_o} = e^{-k_r t}$$

$$\Delta x = \Delta x_o e^{-k_r t}$$

Where $k_r = k_1 + k_{-1}$.

Exercise: 1

The relaxation time for fast reaction $A \xrightleftharpoons[k_{-1}]{k_1} B$ is $10 \mu s$ and the equilibrium constant is 1×10^{-3} . Calculate the rate constant for forward and reversible reaction.

The relaxation time for the given fast reaction is given as:

$$\tau^* = \frac{1}{[k_1 + k_{-1}]} = 10 \mu s = 10 \times 10^{-6} s = 10^{-5} s$$

Since the k_1 is far greater than k_{-1} ($k_1 \lll k_{-1}$),

$$\tau^* = \frac{1}{k_1}$$

(or)

$$10^{-5} s = \frac{1}{k_1}$$

$$k_1 = 10^5 s^{-1}$$

We know that the equilibrium constant (K) for the given reversible reaction is:

$$K = \frac{k_1}{k_{-1}}$$

Given that the equilibrium constant for the given fast reaction is 1×10^{-3} . Therefore, the rate constant for reversible reaction is:

$$k_{-1} = \frac{k_1}{K}$$

$$k_{-1} = \frac{10^5}{1 \times 10^{-3}} s^{-1}$$

$$k_{-1} = 10^8 s^{-1}$$

9. Catalysis:

9.1. Role of a catalyst:

We can employ catalyst for increase the rate of a reaction because catalyst can provide an alternative pathway with low activation energy, so more reactant molecules can cross the activation energy barrier at given concentration and temperature.

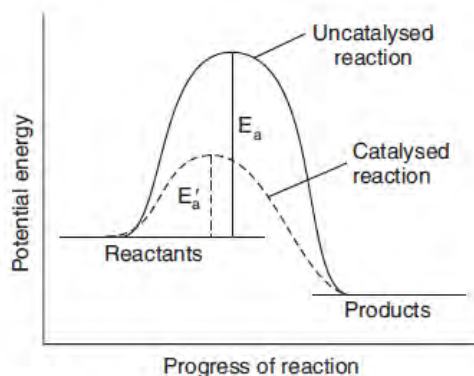

E_T = threshold energy of the uncatalysed reaction
 E'_T = threshold energy of the catalyzed reaction
 E_R = Energy of the reactant
 E_P = Energy of the product

Advantages of using catalyst instead of using high temperature to promote a chemical reaction

- (a) Better to control of the reaction
- (b) Low energy cost due to lower temperature (more economical)
- (c) Fewer side reactions thereby providing higher yield of the desired products.

What is catalyst

Catalyst is defined as a substance, a small quantity of which alter (increase or decrease) the velocity of a chemical reaction by its mere presence, without itself undergoing any change in mass and composition at the end of the reaction.

The phenomenon of altering the velocity of a chemical reaction by the presence of a catalyst is called catalysis.

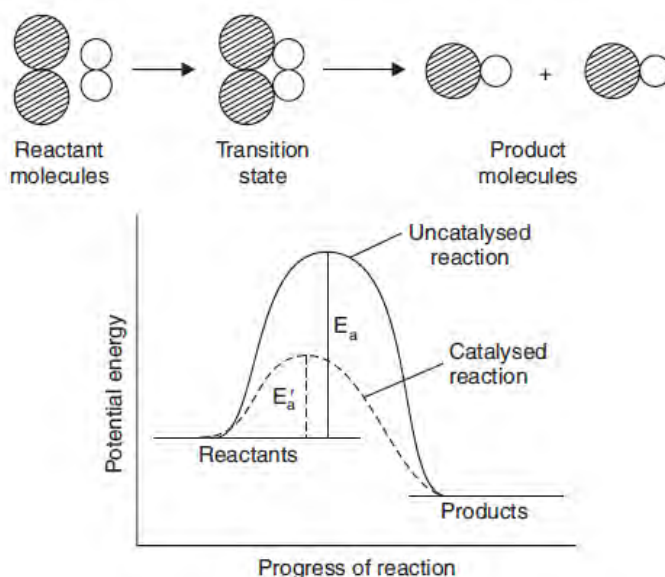

9.2. Types of catalyst:

(a) Positive catalyst: A positive catalyst is a catalyst which accelerates the speed of the reaction (also known as accelerator)

Examples: (i) In hydrogenation reaction of oil during the manufacture of vegetable ghee by Nickel (150-300°C)

(ii) MnO_2 in the decomposition of KClO_3 into KCl and O_2

(iii) Platinum black or V_2O_5 in the oxidation of SO_2 by atmospheric oxygen to SO_3 (contact process)

(b) Negative catalyst: If the catalytic substances retard the chemical reaction, it is called negative catalyst (also known as inhibitor)

Examples: (i) Alcohol retard the oxidation of chloroform to poisonous phosgene

(ii) Tetraethyl lead acts as anti-knock material in internal combustion engine.

Positive Catalysis

<i>Reaction</i>	<i>Catalyst</i>
(i) $2\text{KClO}_3 \longrightarrow 2\text{KCl} + 3\text{O}_2$	MnO_2
(ii) $2\text{H}_2\text{O}_2 \longrightarrow 2\text{H}_2\text{O} + \text{O}_2$	Pt
(iii) $2\text{SO}_2 + \text{O}_2 \longrightarrow 2\text{SO}_3$	Pt or V_2O_5
(iv) $\text{N}_2 + 3\text{H}_2 \longrightarrow 2\text{NH}_3$	Fe
(v) $\text{C}_{12}\text{H}_{22}\text{O}_{11} + \text{H}_2\text{O} \longrightarrow \text{C}_6\text{H}_{12}\text{O}_6 + \text{C}_6\text{H}_{12}\text{O}_6$	H^+ ion

Negative Catalysis

<i>Reaction</i>	<i>Catalyst</i>
(i) $2\text{H}_2\text{O}_2 \longrightarrow 2\text{H}_2\text{O} + \text{O}_2$	H_2SO_4
(ii) $2\text{H}_2 + \text{O}_2 \longrightarrow 2\text{H}_2\text{O}$	CO

9.3. Characteristics of catalysts:

1. A catalyst remains unchanged in mass and composition at the end of the reaction though a change in physical state, color etc. may occur.

As for example, granular MnO_2 (manganese dioxide) used as a catalyst during the decomposition of Potassium Chlorate (KClO_3), is recovered as fine powder after the reaction.

It is believed that MnO_2 catalyzed reaction for the preparation of oxygen takes place as follows-

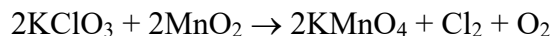

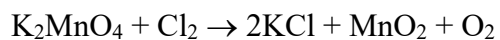

2. A small amount of catalyst is sufficient to bring an appreciable change in the velocity of the reaction. Example: The presence of even 1 mg of fine pt powder is enough to catalyze the combination of 2.5 liters mixtures of H_2 and O_2 to form water. Rate also increases in the increase in the surface area of the catalyst.

3. A catalyst can exert a selective action like a key can open a particular lock. Some catalysts are very specific in respect of reaction and change of a catalyst may divert the path of the same reaction to different products.

Examples: (i) water gas (a mixture of CO and H_2) is converted to –

(a) Methanol when passed over ZnO and Cr_2O_3 at 400°C

(b) Methane when passed over a Nickel catalyst at 400°C

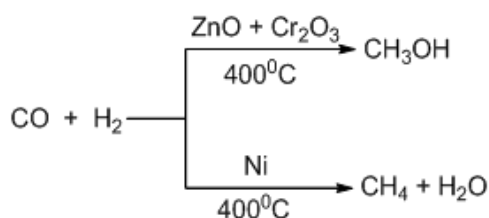

(c) Decomposition of formic acid

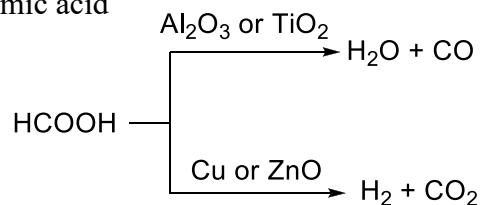

Enzymes also have specific catalytic activity.

4. A catalyst can only alter the speed of the reaction but does not affect the final state of equilibrium since it alters the rate of the forward as well as backward reaction to the same extent, thereby the composition of the equilibrium remains the same.

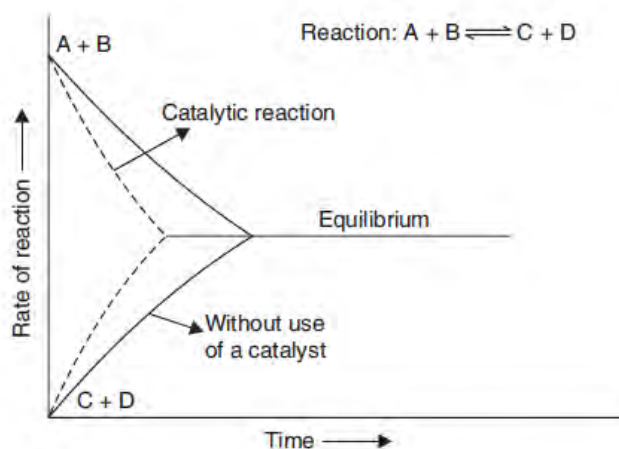

Fig. Effect of catalyst on time to attain equilibrium

5. According to Ostowald, a catalyst cannot initiate the reaction but can only decrease or increase its rate. Initiations of reactions by catalyst are rather rare but not unknown. Example- Perfectly dry H_2 and O_2 does not combine to form water even if they are left in contact for years, but in presence of little water (catalyst), the reaction proceeds quite rapidly.

6. A catalyst is most active at a particular temperature, called the optimum temperature.

7. The addition of a small amount of foreign substances, which are not themselves catalytically active, sometimes increase the catalytic activity of the catalyst. Such substances which catalyze the catalyst are called promoters.

Examples: In the manufacture of ammonia by Habers Process, finely divided Fe acts as a catalyst while Molybdenum (or a mixture of alumina, Al_2O_3 and K_2O) acts as a promoter.

Similarly, in the manufacture of methanol from CO and H_2 , the activity of the catalyst ZnO is greatly enhanced by the presence of Chromium sesquioxide, the promoter.

The properties of promoters are- (i) Selectively enhancement of the reactions; (ii) Increase catalyst lifetime.

8. The activity of a catalyst is inhibited or completely destroyed by the presence of even minute traces of certain substances, called catalytic posion or anti-catalyst.

Example: In the manufacture of H_2SO_4 by contact process, a trace of As_2O_3 destroys the catalytic activity and efficiency of spongy Platinum.

(b) In Haber's process, for the manufacture of NH_3 , nitrogen and hydrogen gases in the volume ratio 1:3 are passed over heated iron catalyst which contains a promoter, molybdenum.

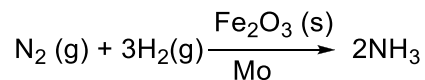

(c) Oxidation of ammonia to nitric oxide in presence of Pt-gauser as catalyst

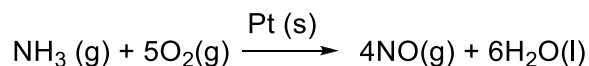

(d) Hydrogenation of unsaturated hydrocarbon in presence of nickel as a catalyst.

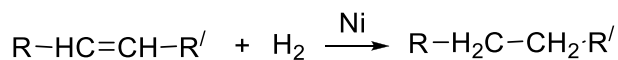

Auto-catalysis:

When a product formed in the course of the reaction enhances the velocity of the reaction (or acts as a catalyst), the phenomenon is called autocatalysis. In other words, if one of the products of a reaction is capable of catalyzing the same reaction in which it is produced this is called autocatalysis.

Examples: when an oxalate reacts with acidified KMnO_4 solution, the $\text{Mn}(\text{II})$ ions (resulting from the reduction of permanganate) catalyze the reaction. When oxalic acid is added to an acidified solution of Potassium permanganate, no appreciable de-colorization occurs for a comparatively long period of time but once the de-colorization occurs, it proceeds rapidly.



Many hydrolysis reactions are catalysed by acids. When esters are hydrolysed since one of the products is an acid, the reaction is autocatalytic.

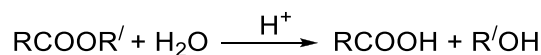

$\text{Mn}(\text{II})$ ions are not present before the reaction starts and so it starts off extremely slowly at room temperature. However, once the $\text{Mn}(\text{II})$ is produced, the reaction proceeds rapidly.

9.5 Acid-base catalysis:

Acid-base catalysis is an example of homogenous catalysis which is catalyzed by Bronsted acid or base or both.

(i) Specific proton catalyzed reaction (H^+ ion catalysis): A reaction which is catalyzed by H^+ or H_3O^+ ions but not by other proton donors (Bronsted Acids) e.g. solvolysis of esters, inversion of cane sugar, keto-enol tautomerism.

The term specific acid catalysis is used when the reaction rate is dependent on the equilibrium for protonation of the reactant and is governed by concentration of H^+ ion, not other Bronsted acids.

(ii) General acid Catalysis: These are the reactions which are not only catalyzed by H^+ ions but also acids including water. E.g. iodination of acetone

(iii) Specific OH^- ion catalysis: A reaction which is catalyzed by OH^- ion only. E.g. conversion of acetone to diacetone alcohol which is catalyzed by OH^- ion.

(iv) Generalized base catalysis: These are the reactions which are not only catalyzed by OH^- ions but also by other bases eg. OAc^-

(v) Reaction catalyzed by both H^+ and OH^- ions: Hydrolysis of ester is an example where both H^+ ion and OH^- ion can catalyze the hydrolysis process.

Kinetics of acid catalyzed reaction:

Mechanism 1:

We assume that a proton is transferred from an acid AH^+ to the substrate S. The acid form the substrate SH^+ then reacts with water molecule to form the product P.

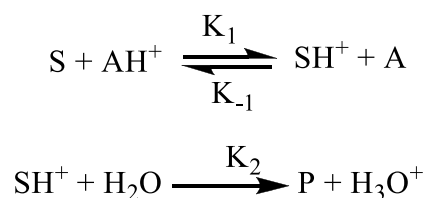

Applying steady state approximation for SH^+ , we have,

$$\text{Rate of formation of } SH^+ = \text{rate of consumption of } SH^+$$

$$K_1[S][AH^+] = K_{-1}[A][SH^+] + K_2[SH^+][H_2O]$$

For very dilute solution, concentration of $[H_2O]$ almost remain constant, so

$$K_1[SH][AH^+] = K_{-1}[A][SH^+] + K_2[SH^+]$$

Solving for $[SH^+]$. We have

$$[SH^+] (K_{-1}[A] + K_2) = K_1[S] [AH^+]$$

$$K_2[SH^+] = \frac{K_1 K_2 [S] [AH^+]}{K_{-1}[A] + K_2}$$

The rate of formation of product is given by,

$$d[P]/dt = K_2[SH^+] = \frac{K_1 K_2 [S] [AH^+]}{K_{-1}[A] + K_2}$$

Let us discuss two limiting cases,

Case I: If $K_2 \gg K_{-1}[A]$, so there is always only a small $[SH^+]$.

$$d[P]/dt = K_1[S][AH^+]$$

As the rate depends on $[AH^+]$, hence the reaction is **generalized acid catalysis**.

Case II: If $K_2 \ll K_{-1}[A]$, SH^+ may be considered to be in equilibrium with reactant.

$$d[P]/dt = \frac{K_1 K_2 [S] [AH^+]}{K_{-1} [A]} \times \frac{[H^+]}{[H^+]} = \frac{K_1 K_2 [S] [H^+]}{K_{-1} K}$$

Where K is the ionization constant of $[AH^+]$



From the equation the rate is proportional to the $[H^+]$, it is an example of **specifically acid catalyzed reaction**.

Mechanism 2:

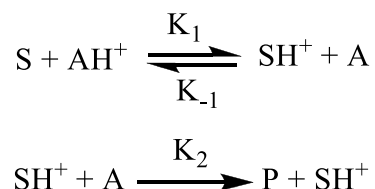

We assume that in the second step, the acid form of the substrate reacts with a base instead of water molecule.

Applying steady state approximation, $K_1[S][AH^+] = K_{-1}[A][SH^+] + K_2[SH^+][A]$

$$[SH^+] (K_{-1}[A] + K_2[A]) = K_1[S][AH^+]$$

$$[SH^+] = \frac{K_1[S][AH^+]}{K_{-1}[A] + K_2[A]}$$

The rate of the reaction is

$$\begin{aligned} d[P]/dt &= K_2[SH^+][A] \\ &= \frac{K_1 K_2 [A][S][AH^+]}{(K_{-1} + K_2)[A]} \\ &= \frac{K_1 K_2 [S][AH^+]}{K_{-1} + K_2} \end{aligned}$$

From the above equation, it is obvious that the rate of the reaction is proportional to $[AH^+]$, it is an example of **general acid catalysis**.

Examples:

(i) Hydrolysis of esters: This is a specific acid catalyzed reaction when the reaction rate is dependent on the equilibrium for the protonation of reaction.

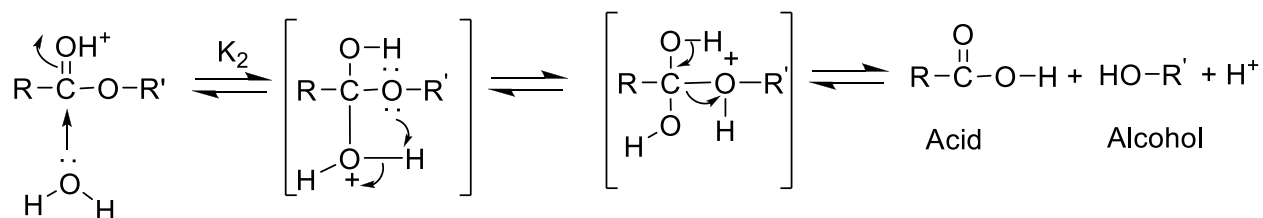
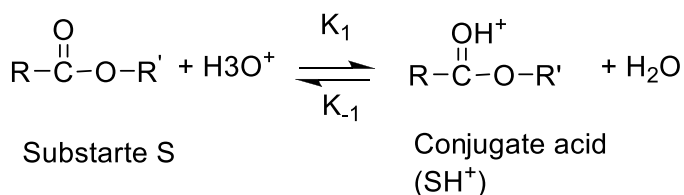

$$\text{Rate} = \text{K}_2[\text{SH}^+]$$

$$[\text{SH}^+] = \frac{\text{K}_1\text{K}_2[\text{RCOOR}][\text{H}^+]}{\text{K}_{-1} + \text{K}_2}$$

Base catalyzed hydrolysis of esters.

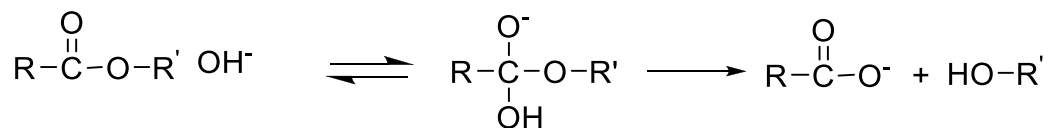

(ii) Halogenation of acetone:

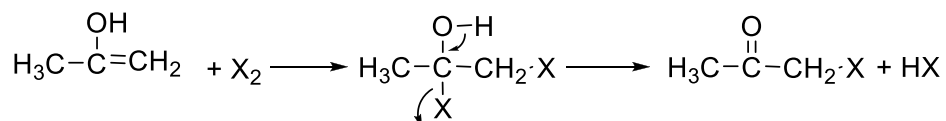
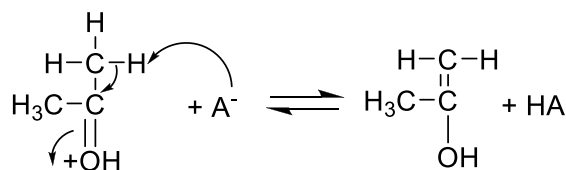
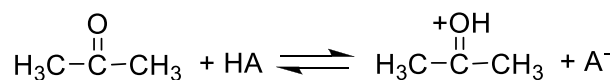

Rate determining step is the enolisation of acetone followed by a rapid addition of halogen to the enol. The enolisation of acetone is catalyzed by acids or bases.

Base catalyzed enolisation of acetone and halogenation:

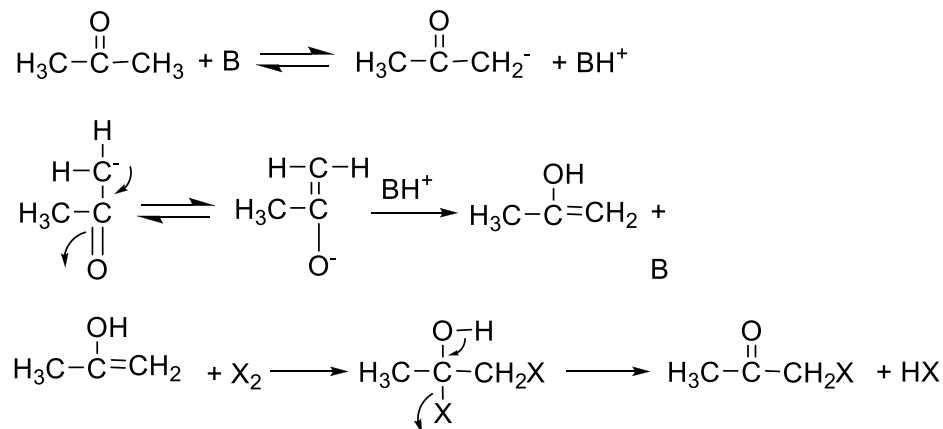

9.6. Enzymes or biological catalyst:

Enzymes are highly complex, non-living nitrogenous organic substances produced by living animals and plants. They possess the incredible capacity in bringing about many complex chemical reactions like hydrolysis, oxidation, reduction etc. They are highly specific and each enzymes can catalyze a specific reaction. It also lowers the activation energy for a particular reaction. Examples:

(i) Starch is catalyzed by diastase to form maltose in turn by maltase into glucose.

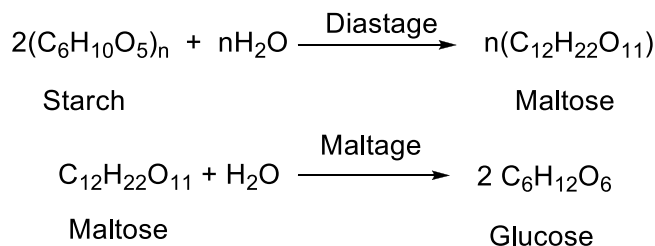

(ii) Invertase converts cane sugar into a mixture of glucose and fructose while zymase converts glucose and fructose into alcohol.

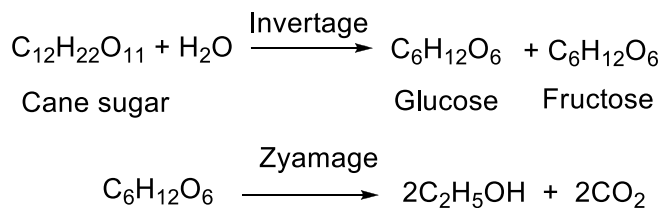

(iii) The enzymes urease (present in Soyabeans) converts urea quantitatively into ammonia and CO₂ or (NH₄)₂CO₃.

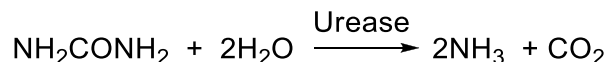

The enzymes ptyalin present in human mouth (saliva) converts starch into glucose.

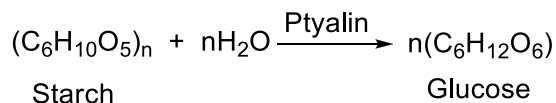

9.6.1. Characteristics of Enzymes:

(i) Enzymes are protein that can acts as enormously effective catalyst and can speed up the reaction by high factors of upto 10¹².

(ii) They are highly specific and each enzymes catalyze a particular reaction. (Key and Lock).

(iii) All enzyme reaction exhibits maximum efficiency at optimum temperature. Above this temperature the enzymes gets denatured, thereby losing its activity.

For most enzymes, the reaction rates increases upto 450C and above 450C, thermal denaturation take place. Above 550C, rapid thermal denaturation destroys completely the catalytic activity of the enzyme protein. Enzyme decreases the activation energy of a reaction at a given temperature.

(iv) Enzyme catalyzed reactions are much more sensitive to catalytic poison such as HCN, CS₂, H₂S etc. the inhibitors (or poisons) interact with the functional groups present on the enzyme surface and often reduce or completely destroy the catalytic activity of the enzyme.

(v) Activity of certain enzymes depends upon certain non-protien substances called co-enzymes. For each enzyme, there is only one co-enzymes.

(vi) Enzymes loose their activity when exposed to UV radiation or in presence of electrolyte.

(vii) The effect of PH on the rate of enzyme catalysed reaction is of complex nature. Usually the rate possess through a maximum as the PH increased. (PH 5-7)

(viii) Even a small amount of an enzyme can be highly efficient in bringing about a particular biological reaction.

(ix) Enzyme does not disturb the final state of equilibrium.

9.6.2. Mechanism and kinetic of enzyme catalysed reaction:

L. Michaelis and Mary Menten proposed a mechanism for the kinetics of enzyme catalysed reactions which involves the following steps-

Step 1: Formation of enzyme-substrate complex

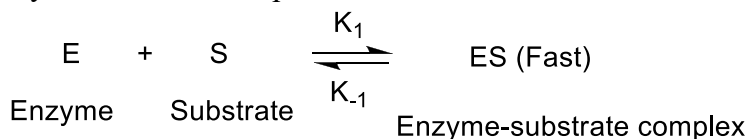

Step 2: Decomposition of the enzyme-substrate complex to give the products.



Now the enzyme is consumed in step 1 and but regenerated in backward step. Since step 2 is slow (rate determining) so the rate of the reaction is given by,

$$\text{Rate} = \frac{-d[\text{S}]}{dt} = + \frac{d[\text{P}]}{dt} = \text{K}_2[\text{ES}]$$

Using the steady state approximation with respect to ES,

Rate of formation of ES = Rate of consumption of ES

$$\text{K}_1[\text{E}][\text{S}] = \text{K}_{-1}[\text{ES}] + \text{K}_2[\text{ES}]$$

$$\frac{d[\text{ES}]}{dt} = \text{K}_1[\text{E}][\text{S}] - \text{K}_{-1}[\text{ES}] - \text{K}_2[\text{ES}] = 0$$

The equilibrium between the free and bound enzyme E and ES is given by the equation,

$$[\text{E}]_o = [\text{E}] + [\text{ES}]$$

$$[\text{E}] = [\text{E}]_o - [\text{ES}]$$

Where, $[\text{E}]_o$ = total enzyme concentration which can be measured

$[\text{E}]$ = free enzyme concentration which cannot be measured

$[\text{ES}]$ = Reacted or bound enzyme concentration

$$\begin{aligned} \frac{d[\text{ES}]}{dt} &= \text{K}_1[\text{E}][\text{S}] - \text{K}_{-1}[\text{ES}] - \text{K}_2[\text{ES}] = 0 \\ &= \text{K}_1\{[\text{E}]_o - [\text{ES}]\}[\text{S}] - \text{K}_{-1}[\text{ES}] - \text{K}_2[\text{ES}] = 0 \\ &= \text{K}_1[\text{E}]_o[\text{S}] - \text{K}_1[\text{ES}][\text{S}] - (\text{K}_{-1} + \text{K}_2)[\text{ES}] = 0 \end{aligned}$$

$$[\text{ES}] = \frac{\text{K}_1[\text{E}]_o[\text{S}]}{\text{K}_1[\text{S}] + \text{K}_{-1} + \text{K}_2}$$

Dividing by K_1 , we get,

$$\text{Rate (r)} = \frac{K_2[E]_o [S]}{(K_{-1} + K_2) + [S]} = \frac{K_2[E]_o [S]}{K_m + [S]}$$

$$\text{where, } K_m = \frac{K_{-1} + K_2}{K_1}$$

This equation is known as Michaelis-Menten equation and K_m is known as Michaelis constant. When all the enzymes has reacted with the substrate at high concentration, the rate of the reaction will be maximum. Under this condition, no free enzyme will be remain and hence,

$$[E]_o = [ES]$$

$$\text{Maximum rate} = V_{\max} = K_2[ES] = K_2[E]_o$$

Where K_2 is called turn over number of the enzyme. The number of molecules converted in unit time by one molecule of enzyme is called turn over number and its value ranges from 100-1000s⁻¹ but can be 10⁵-10⁶ s⁻¹.

Now the rate is given by,

$$\text{Rate (r)} = \frac{V_{\max} [S]}{K_m + [S]}$$

Case I: If, $K_m \gg [S]$, then we get, neglecting S in the denominator,

Thus, the enzyme catalyzed reaction is of first order, when the substrate concentration is low.

$$\text{Rate (r)} = \frac{V_{\max} [S]}{K_m} = K' [S]$$

Case II: If $K_m \ll [S]$, so that we can neglect K_m , then,

$$\text{Rate (r)} = \frac{V_{\max} [S]}{K_m} = V_{\max} = \text{constant}$$

Enzyme catalyzed reaction is zero order when substrate concentration is high.

Case III: If, $K_m = [S]$, then,

$$\text{Rate (r)} = \frac{V_{\max} [S]}{[S] + [S]} = \frac{1}{2} V_{\max}$$

i.e. Michaelis constant is that concentration of the substrate at which rate of formation of products is equal to half the maximum rate of formation of products at high concentration of the substrate.

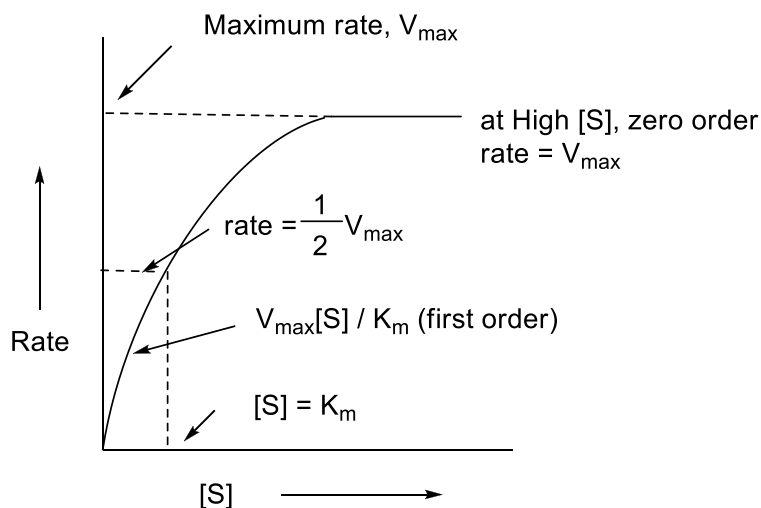

Fig. A plot of Michaelis-Menten equation

N.B.: Why the reaction rate of an enzyme-catalyzed reaction changes from 1st order to zero order as the substrate concentration is increased?

Ans: Each enzyme molecule has one or more ‘active’ sites at which the substrate must be bound in order that the catalytic action may occur. At low substrate concentration, most of these active sites unoccupied at any time. As the substrate concentration is increased, the number of active sites which are occupied increases and hence the reaction rate also increases. However, at very high substrate concentration, virtually all the active sites are occupied at any time so that further increase in substrate concentration can not further increase the formation of enzyme-substrate complex.

The Lineweaver-Burk method: It is rather difficult to determine V_{max} (and hence K_m) directly from the plot of rate vs [S]. It is possible by rearranging Michaelis-Menten equation

$$\frac{1}{\text{Rate (r)}} = \frac{K_m + [S]}{V_m [S]} = \frac{K_m}{V_{\max} [S]} + \frac{1}{V_{\max}}$$

A plot of 1/r against 1/[S] gives a straight line whose intercept on the x-axis and y-axis are (-1/K_m) and 1/V_{max}, respectively and slope is (K_m/V_{max}), as shown in the Fig. below.

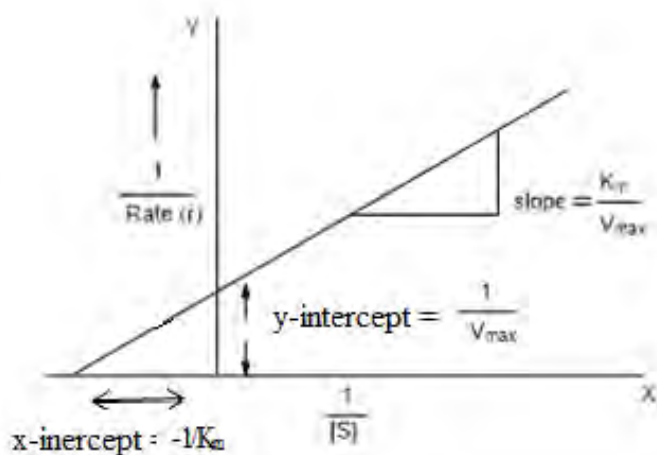

Fig. A plot of $1/r$ vs $1/[S]$ i.e. Lineweaver-Burk plot

Important catalysts in industrial processes, Hydrogenation using Wilkinsons catalyst, Hydroformylation by using Cobalt-catalyst

Applications of Catalysts for industrially important Processes:

Sl No	Process	Catalyst	Temp	Reaction	Remarks
1	Haber's Process	Fe	450 ⁰ C	$N_2 + 3H_2 \rightarrow 2NH_3$	It is used for the manufacture of ammonia; $Al_2O_3 + K_2O$ or Mo is also used as Promoters

2	Contact Process	V ₂ O ₅ or Platinised asbestos	450 ⁰ C	2SO ₂ + O ₂ → 2SO ₃	It is used for the manufacture of sulfuric acid
3	Chamber Process	NO		2SO ₂ + O ₂ → 2SO ₃	It is used for the manufacture of sulfuric acid
4	Bosch's Process	Fe ₂ O ₃	400-450 ⁰ C	(CO + H ₂) + H ₂ O → CO ₂ + 2H ₂	It is used for the manufacture of H ₂ . Cr ₂ O ₃ is used as promoter.
5	Ostwald Process	Platinised Asbestos	300 ⁰ C	4NH ₃ + 5O ₂ → 4NO + 6H ₂ O; 2NO + O ₂ → 2NO ₂ 4NO ₂ + 2H ₂ O + O ₂ → 4HNO ₃	Excess of air (as promoter) is also required.
6	Bergius Process	Tin or Nickel oleate	450 ⁰ C	Coal → Gasoline	Heavy oil is also required for making paste of coal with catalyst.
7	Hardening of oil	Nickel	150-300 ⁰ C	Oils → Fats $\text{H}_2\text{C}=\text{CH}_2 + \text{H}_2 \xrightarrow{\text{Cat}} \text{CH}_3\text{CH}_3$	It is used for the manufacture of vegetable ghee from vegetable oil.

Hydrogeneation reaction by Wilkinson's Catalyst: (PPh₃P)₃RhCl

Tris-triphenyl phosphine Rhodium Chloride, (PPh₃P)₃RhCl which is generally known as Wilkinson's Catalyst acts as a homogenous catalyst for the hydrogenation of alkenes and alkynes. The catalyst is not able to reduce other functional groups although it is very reactive compound. The mechanism of the reaction is given below:

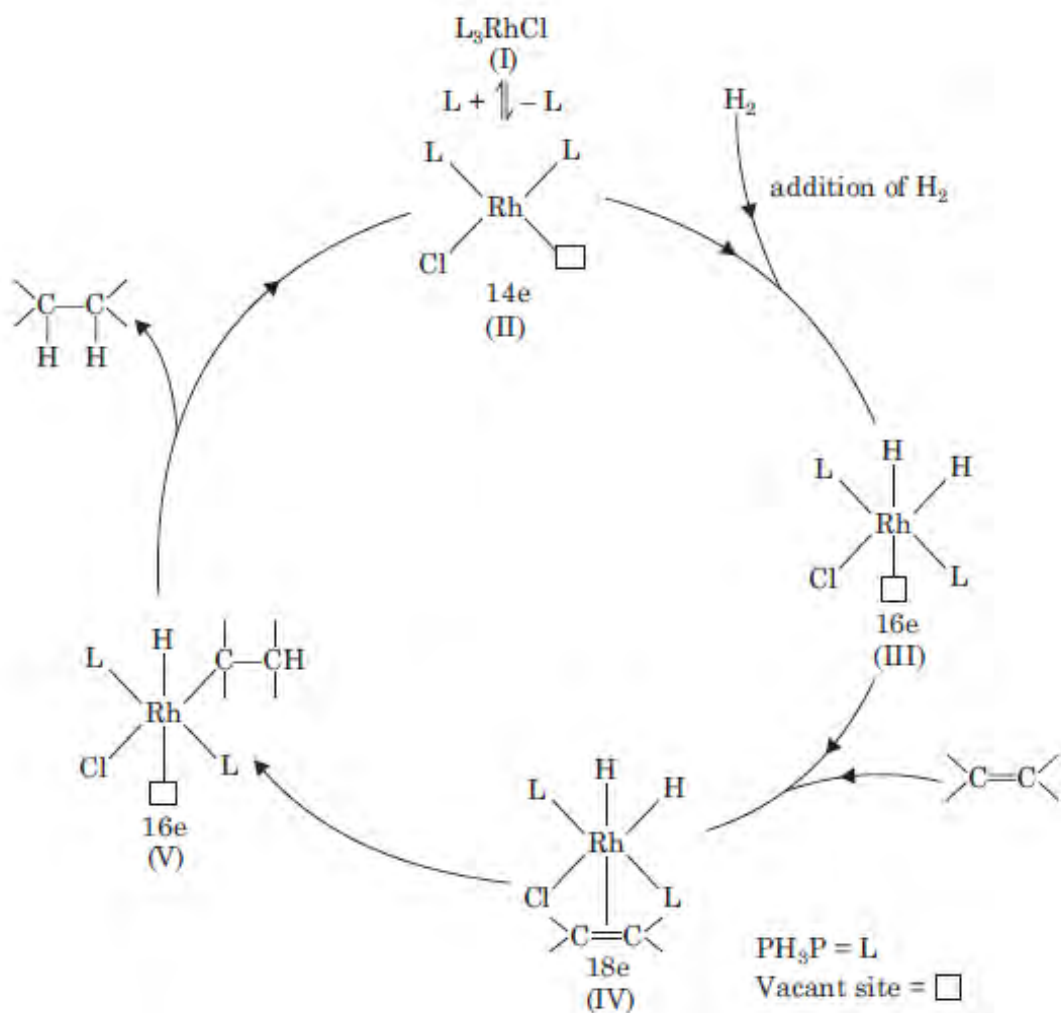

Figure: Mechanism of hydrogenation reaction using Wilkinson's Catalyst

Phase Transfer Catalyst:

In chemistry, a phase-transfer catalyst (PTC) is a catalyst that facilitates the migration of a reactant from one phase into another phase where reaction occurs. Phase-transfer catalysis is a special form of heterogeneous catalysis. Ionic reactants are often soluble in an aqueous phase but insoluble in an organic phase in the absence of the phase-transfer catalyst. The catalyst functions like a detergent for solubilizing the salts into the organic phase. Phase-transfer catalysis refers to the acceleration of the reaction upon the addition of the phase-transfer catalyst.

By using a PTC process, one can achieve faster reactions, obtain higher conversions or yields, make fewer byproducts, eliminate the need for expensive or dangerous organic solvents that will dissolve all the reactants in one phase, eliminate the need for expensive raw materials and/or minimize waste problems.

Phase-transfer catalysts are especially useful in **green chemistry**—by allowing the use of water, the need for organic solvents is reduced.

Examples of Phase-transfer catalysts:

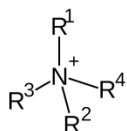

X^-

and

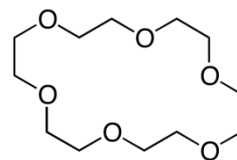

Quaternary ammonium salts (Q^+X^-)

Crown ether

NB: Because of the presence of non-polar hydrocarbon chain polar N^+ ion quaternary ammonium salts are soluble in organic as well as aqueous medium.

Mechanism of Phase-transfer Catalysis:

The mechanism of phase transfer catalysis involves two fundamental processes (i) transfer of one reagent from its normal phase to the phase of other reagent and (ii) reaction of the transferred reagent or ion-pair with the non-transferred reagent within the organic layer.

Phase transfer catalysis can be easily explained using the following common nucleophilic displacement reaction using Q^+X^- as PTC,



In general,



(Alkyl halide soluble in organic solvent but insoluble in water)

(Inorganic salt soluble in water but insoluble in organic solvent)

The reaction cannot be carried out only in organic solvent or in aqueous medium.

This problem can be solved on addition of Q^+X^- as catalyst, the nucleophile Y^- available in the aqueous solution reacts with alkyl halide RX which is present in organic phase.

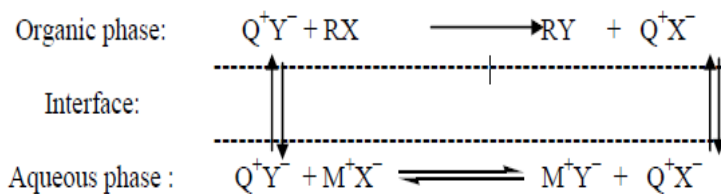

An overview of PTC reactions is given in the scheme above:

The ion pair (Q^+Y^-) is generated in aqueous phase by reaction between salt of alkali metal M^+Y^- and catalyst (Q^+X^-). Owing to the oleophilic character of Q^+ , the anion Y^- is extracted into the organic phase across the interface. Here the necessary contact with alkyl halide is established and displacement reaction takes place. The displaced anion X^- is transferred back into aqueous phase in the form of an ion pair Q^+X^- and the cycle is completed.

Applications of phase-transfer catalyst:

PTC are not only used in organic chemistry but also a broadly useful tool in several other areas of chemistry viz., inorganic chemistry, electrochemistry, photochemistry, heterocyclic chemistry, industrial chemistry, medicinal chemistry and especially in polymer chemistry. The field of PTC has grown-up spectacularly over the past few decades, paving many new applications in the chemical, fine chemical and pharmaceutical industries. Primary applications are in nucleophilic substitution reactions and in reactions in the presence of bases involving the deprotonation of moderately and weakly acidic organic compounds. Typical reactions where PTCs employ as catalysts include, alkylation, displacements reactions, oxidation, transition metal co-catalyzed reactions (carbonylation, reduction and hydrogenation), condensations, carbene reactions, additions, polymerization, dehydrohalogenation, and so on, which are often part of a multi-step synthetic process for the manufacture of fine chemicals.

MODULE IV

Introduction

The molecular spectroscopy is the study of the interaction of electromagnetic waves and matter. The scattering of sun's rays by raindrops to produce a rainbow and appearance of a colorful spectrum when a narrow beam of sunlight is passed through a triangular glass prism are the simple examples where white light is separated into the visible spectrum of primary colors. This visible light is merely a part of the whole spectrum of electromagnetic radiation, extending from the radio waves to cosmic rays. All these apparently different forms of electromagnetic radiations travel at the same velocity but characteristically differ from each other in terms of frequencies and wavelength (Table 1).

Table 1: The electromagnetic spectrum

Radiation type	Wave length λ , (Å)	Frequency $\nu = c / \lambda$, (Hz)	Applications
radio	10^{14}	3×10^4	
Nuclear magnetic resonance	10^{12}	3×10^6	
Television	10^{10}	3×10^8	Spin orientation
Radar	10^8	3×10^{10}	
Microwave	10^7	3×10^{11}	Rotational
Far infrared	10^6	3×10^{12}	Vibrational
Near infrared	10^4	3×10^{14}	
Visible	$8 \times 10^3 - 4 \times 10^3$	$3.7 \times 10^{14} - 7.5 \times 10^{14}$	
Ultraviolet	3×10^3	1×10^{15}	Electronic
X-rays	1	3×10^{18}	
Gamma rays	10^{-2}	3×10^{20}	Nuclear transitions
Cosmic rays	10^{-4}	3×10^{22}	

The propagation of these radiations involves both electric and magnetic forces which give rise to their common class name electromagnetic radiation. In spectroscopy, only the effects associated with electric component of electromagnetic wave are important. Therefore, the light wave traveling through space is represented by a sinusoidal trace (figure 1). In this diagram λ is the wavelength and distance A is known as the maximum amplitude of the wave. Although a wave is frequently characterized in terms of

its wavelength λ , often the terms such as wavenumber , frequency (ν), cycles per second (cps) or hertz (Hz) are also used.

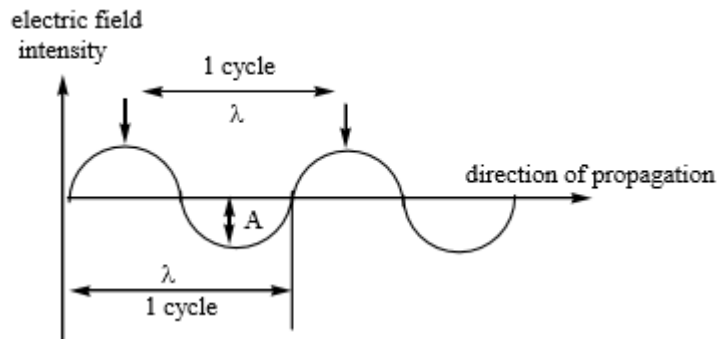

Figure 1: Wave like propagation of light (λ = wavelength , A = amplitude)

The unit commonly used to describe the wavelength is centimeters (cm), the different units are used to express the wavelengths in different parts of the electromagnetic spectrum. For example, in the ultraviolet and visible region, the units use are angstrom (\AA) and nanometer (nm). In the infrared region, the commonly used unit is wavenumber (cm^{-1}), which gives the number of waves per centimeter. The four quantities wavelength, wavenumber, frequency and velocity can be related to each other by following relationships:

$$\text{Wavelength } (\lambda) = 1 / \bar{\nu} = c / \nu$$

$$\text{Wave-number } (\bar{\nu}) = 1 / \lambda = \nu / c$$

$$\text{Frequency } (\nu) = c / \lambda = c \bar{\nu}$$

$$\text{Velocity } (c) = \nu \lambda = \nu / \bar{\nu}$$

Absorption spectroscopy

Electrons of an element which are in the ground state may absorb incident energy in order to reach a higher energy state. The frequencies of light transmitted through this substance, with dark bands showing absorbed light, constitute the **absorption spectrum** of the substance.

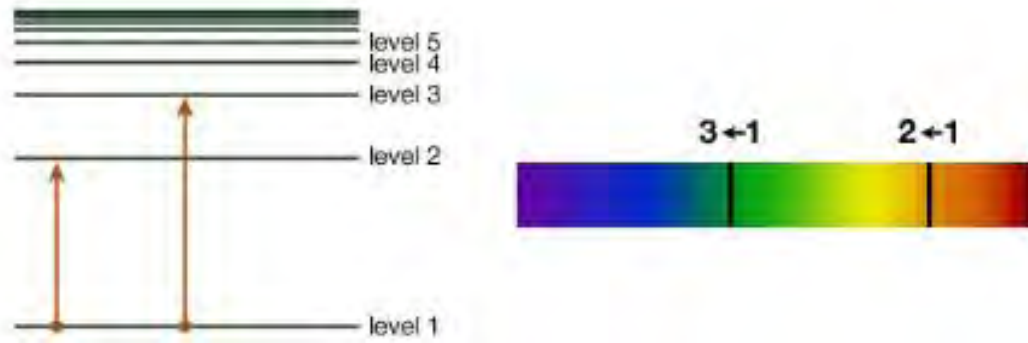

Figure 2: The concept of Absorption spectroscopy

The spectroscopic studies based on 'absorbance' of light at concerned frequency (corresponding to the energy gap) is called **absorption spectroscopy** (Figure 2).

All types of spectroscopy discussed heron are absorption spectroscopy.

Lambert – Beer's law

Lambert's law stated that absorbance of a material sample is directly proportional to its thickness (path length). Much later, August **Beer** discovered another attenuation relation in 1852. **Beer's law** stated that absorbance is proportional to the concentrations of the attenuating species in the material sample.

Combination of these two laws resulted in Lambert – beer's law, which states that absorbance of a monochromatic light passing through a medium is proportional to both thickness(l) of the medium as well as the concentration (c) of the absorbing species.

Mathematically,

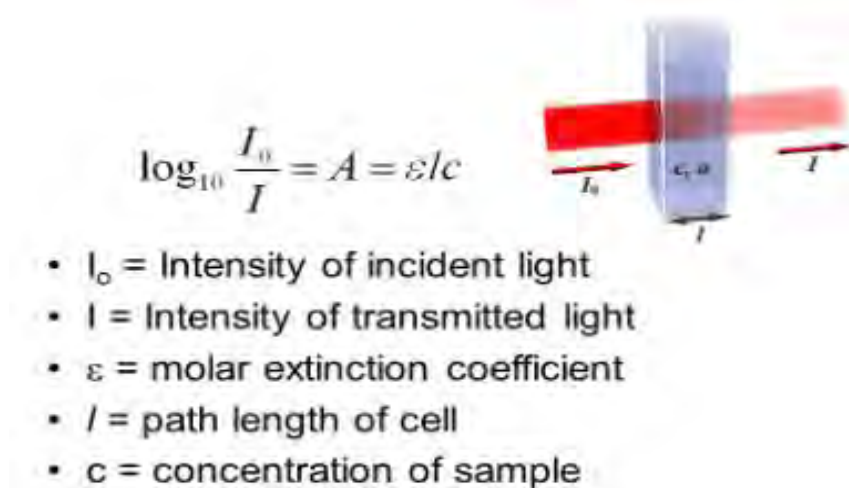

Figure 3: Concept of Lambert-Beer's Law

Limitations of Lambert – Beer's law

The linearity of the Beer-Lambert law is limited by chemical and instrumental factors. Causes of nonlinearity include:

- deviations in absorptivity coefficients at high concentrations (>0.01M) due to electrostatic interactions between molecules in close proximity
- scattering of light due to particulates in the sample
- fluorescence or phosphorescence of the sample
- changes in refractive index at high analyte concentration
- shifts in chemical equilibria as a function of concentration
- non-monochromatic radiation, deviations can be minimized by using a relatively flat part of the absorption spectrum such as the maximum of an absorption band
- stray light

UV – VIS Spectroscopy

This absorption spectroscopy uses electromagnetic radiations between 190 nm to 800 nm and is divided into the ultraviolet (UV, 190-400 nm) and visible (VIS, 400-800 nm) regions. Since the absorption of ultraviolet or visible radiation by a molecule leads transition among electronic energy levels of the molecule, it is also often called as electronic spectroscopy. The information provided by this spectroscopy when combined with the information provided by NMR and IR spectral data leads to valuable structural proposals. Nature of Electronic Transitions The total energy of a molecule is the sum of its electronic, its vibrational energy and its rotational energy. Energy absorbed in the UV region produces changes in the electronic energy of the molecule. As a molecule absorbs energy, an electron is promoted from an occupied molecular orbital (usually a non-bonding n or bonding π orbital) to an unoccupied molecular orbital (an antibonding π^* or σ^* orbital) of greater potential energy (figure 3). For most molecules, the lowest-energy occupied molecular orbitals are σ orbitals, which correspond to σ bonds. The π orbitals lie at relatively higher energy levels than σ orbitals and the non-bonding orbitals

that hold unshared pairs of electrons lie even at higher energies. The antibonding orbitals (π^* and σ^*) are orbitals of highest energy. The relative potential energies of these orbitals and various possible transitions have been depicted in Figure 4.

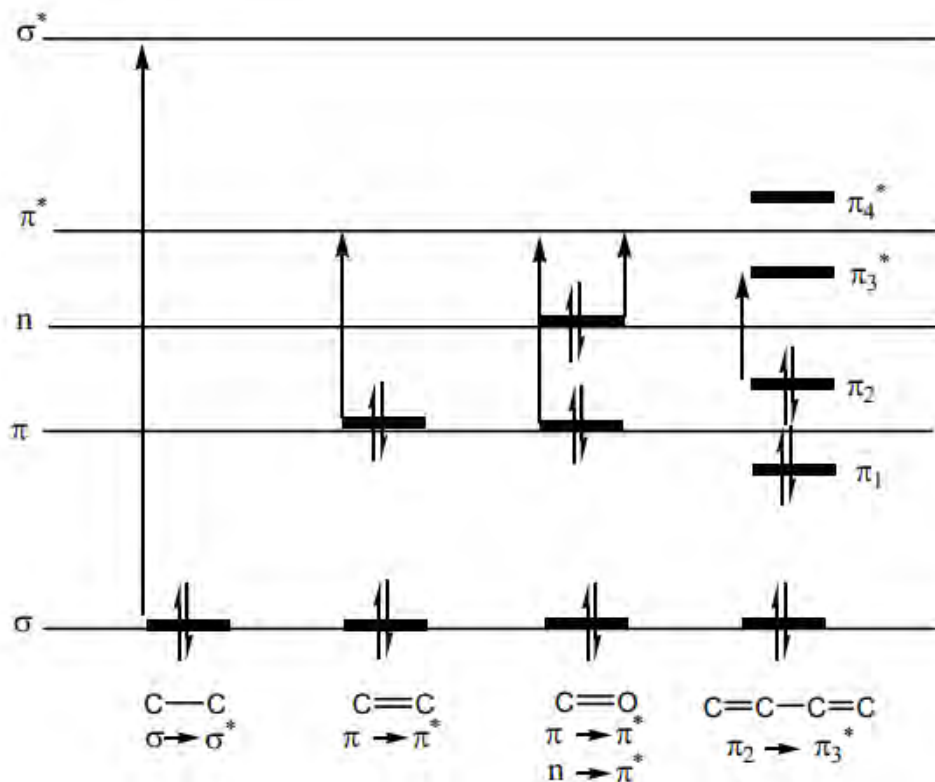

Figure 4: Relative energies of orbitals most commonly involved in electronic spectroscopy of organic molecules

The saturated aliphatic hydrocarbons (alkanes) exhibit only $\sigma \rightarrow \sigma^*$ transitions but depending on the functional groups the organic molecules may undergo several possible transitions which σ^* can be placed in the increasing order of their energies viz. $n \rightarrow \pi^* < n \rightarrow \sigma^* < \pi \rightarrow \pi^* < \sigma \rightarrow \pi^* < \sigma \rightarrow \sigma^*$. Since all these transitions require fixed amount of energy (quantized), an ultraviolet or visible spectrum of a compound would consist of one or more well defined peaks, each corresponding to the transfer of an electron from one electronic level to another. If the differences between electronic energy levels of two electronic states are well defined i.e. if the nuclei of the two atoms of a diatomic molecule are held in fixed position, the peaks accordingly should be sharp. However, vibrations and rotations of nuclei occur constantly and as a result each electronic state in a molecule is associated with a large number of vibrational and rotational states. At room temperature, the molecules in the ground state will be in the zero vibrational level (G_{0_0}). This is shown schematically in figure 5.

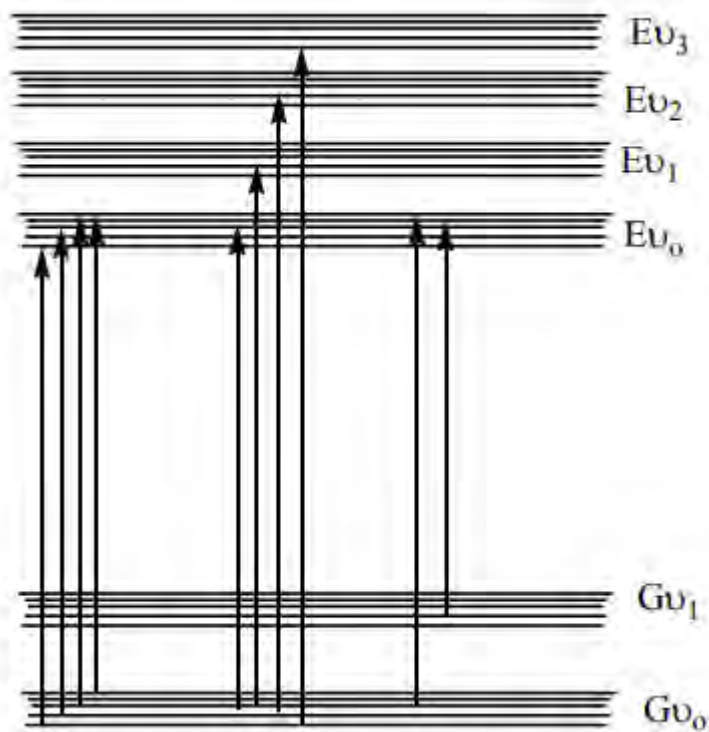

Figure 5: Energy level diagram showing excitation between different vibrational and rotational levels of two electronic states

The transition of an electron from one energy level to another is thus accompanied by simultaneous change in vibrational and rotational states and causes transitions between various vibrational and rotational levels of lower and higher energy electronic states. Therefore many radiations of closely placed frequencies are absorbed and a broad absorption band is obtained. When a molecule absorbs ultraviolet or visible light of a defined energy, an assumption is made that only one electron is excited from bonding orbital or non-bonding orbital to an anti-bonding orbital and all other electrons remain unaffected. The excited state thus produced is formed in a very short time i.e. of the order of 10^{-15} seconds. In accordance with Franck-Condon principle, during electronic excitation the atoms of the molecule do not move. The most probable transition would appear to involve the promotion of one electron from the highest occupied molecular orbital (HOMO) to the lowest unoccupied molecular orbital (LUMO), but in many cases several transitions can be observed, giving several absorption bands in the spectrum. We can have a general view of the possible transitions prevailing in organic compounds.

Alkanes can only undergo $\sigma \rightarrow \sigma^*$ transitions. These are high-energy transitions and involve very short wavelength ultraviolet light (< 150 nm). These transitions usually fall outside the generally available measurable range of UV-visible spectrophotometers (200-1000 nm). The $\sigma \rightarrow \sigma^*$ transitions of methane and ethane are at 122 and 135 nm, respectively. In alkenes amongst the available $\sigma \rightarrow \sigma^*$ and $\pi \rightarrow \pi^*$ transitions, the $\pi \rightarrow \pi^*$ transitions are of lowest energy and absorb radiations between 170-190 nm. In

saturated aliphatic ketones the lowest energy transition involves the transfer of one electron of the nonbonding electrons of oxygen to the relatively low-lying π^* anti-bonding orbital. This $n \rightarrow \pi^*$ transition is of lowest energy (~ 280 nm) but is of low intensity as it is symmetry forbidden. Two other available transitions are $n \rightarrow \pi^*$ and $\pi \rightarrow \pi^*$. The most intense band for these compounds is always due to $\pi \rightarrow \pi^*$ transition. In conjugated dienes the $\pi \rightarrow \pi^*$ orbitals of the two alkene groups combine to form new orbitals – two bonding orbitals named as π_1 and π_2 and two antibonding orbitals named as π_3^* and π_4^* . It is apparent that a new $\pi \rightarrow \pi^*$ transition of low energy is available as a result of conjugation. Conjugated dienes as a result absorb at relatively longer wavelength than do isolated alkenes (see figure 10).

Spectral Measurements

The UV-Vis spectra are usually measured in very dilute solutions and the most important criterion in the choice of solvent is that the solvent must be transparent within the wavelength range being examined. Table 2 lists some common solvents with their lower wavelength cut off limits. Below these limits, the solvents show excessive absorbance and should not be used to determine UV spectrum of a sample.

Solvent Effects

Highly pure, non-polar solvents such as saturated hydrocarbons do not interact with solute molecules either in the ground or excited state and the absorption spectrum of a compound in these solvents is similar to the one in a pure gaseous state. However, polar solvents such as water, alcohols etc. may stabilize or destabilize the molecular orbitals of a molecule either in the ground state or in excited state and the spectrum of a compound in these solvents may significantly vary from the one recorded in a hydrocarbon solvent. (i) $\pi \rightarrow \pi^*$ Transitions In case of $\pi \rightarrow \pi^*$ transitions, the excited states are more polar than the ground state and the dipole-dipole interactions with solvent molecules lower the energy of the excited state more than that of the ground state. Therefore, a polar solvent decreases the energy of $\pi \rightarrow \pi^*$ transition and absorption maximum appears ~ 10 - 20 nm red shifted in going from hexane to ethanol solvent.

Table 2:

Common solvents with their cut-off limits.

S. No.	Solvent	Cut-off wavelength (nm)
1	Acetonitrile	190
2	Water	191
3	Cyclohexane	195
4	Hexane	201
5	Methanol	203
6	95% ethanol	304
7	1,4-dioxane	215
8	Ether	215
9	Dichloromethane	220
10	Chloroform	237
11	Carbon tetrachloride	257
12	Benzene	280

(ii) $n \rightarrow \pi^*$ Transitions In case of $n \rightarrow \pi^*$ transitions, the polar solvents form hydrogen bonds with the ground state of polar molecules more readily than with their excited states. Therefore, in polar solvents the energies of electronic transitions are increased. For example, the figure 6 shows that the absorption maximum of acetone in hexane appears at 279 nm which in water is shifted to 264 nm, with a blue shift of 15nm.

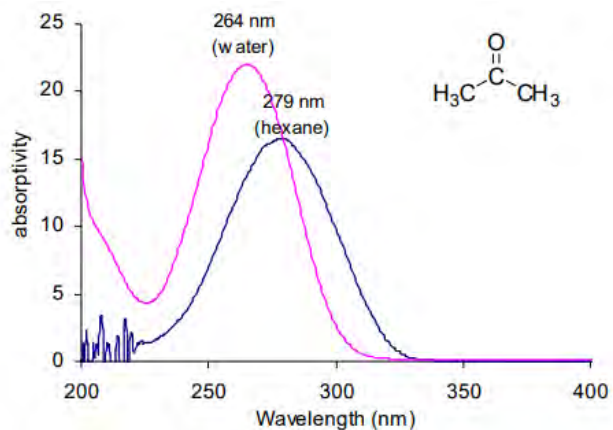

Figure 6 : UV-spectra of acetone in hexane and in water

Some important terms and definitions

(i) **Chromophore:** The energy of radiation being absorbed during excitation of electrons from ground state to excited state primarily depends on the nuclei that hold the electrons together in a bond. The group of atoms containing electrons responsible for the absorption is called chromophore. Most of the simple un-conjugated chromophores give rise to high energy transitions of little use. Some of these transitions have been listed in table 3.

Table 3:

Absorption maxima of simple un-conjugated chromophores

Chromophore	Transition	ϵ_{\max}	λ_{\max} (nm)
<i>σ - bonded electrons</i>			
(C-C, C-H etc.)	$\sigma \rightarrow \sigma^*$		~ 150
<i>Lone pair electrons</i>			
-O-, -N-, -S-	$n \rightarrow \sigma^*$	100-1000	~ 190
C=O, C=N	$n \rightarrow \pi^*$	15	~300
	$\pi \rightarrow \pi^*$	500	~190
R-C \equiv N	$n \rightarrow \pi^*$	5	~ 170
R-COOH, RCONH ₂ , RCOOR	$n \rightarrow \pi^*$	50	~ 210
<i>π- bonded electrons</i>			
C=C	$\pi \rightarrow \pi^*$	14000	~ 190
C \equiv C	$\pi \rightarrow \pi^*$	2000	~ 195
C=O	$\pi \rightarrow \pi^*$	500	~ 180

For example, alkanes contain only single bonds with only possible $\sigma \rightarrow \sigma^*$ type electronic transitions. These transitions absorb radiations shorter than wavelengths that are experimentally accessible in usually available spectrophotometers. In saturated molecules with heteroatom bearing non-bonding pairs of electrons, $n \rightarrow \sigma^*$ transitions become available. These are also high energy transitions. In unsaturated compounds, $\pi \rightarrow \pi^*$ transitions become possible. Alkenes and alkynes absorb ~ 170 nm but the presence of substituents significantly affects their position. The carbonyl compounds and imines can also undergo $n \rightarrow \pi^*$ transitions in addition to $\pi \rightarrow \pi^*$. Amongst these, the most studied

transitions are $n \rightarrow \pi^*$ as these absorb at relatively longer wavelength 280-300 nm. These are low intensity (ϵ 10 -100) transitions.

(ii) **Auxochrome:** The substituents that themselves do not absorb ultraviolet radiations but their presence shifts the absorption maximum to longer wavelength are called auxochromes. The substituents like methyl, hydroxyl, alkoxy, halogen, amino group etc. are some examples of auxochromes.

(iii) **Bathochromic Shift or Red shift:** A shift of an absorption maximum towards longer wavelength or lower energy.

(iv) **Hypsochromic Shift or Blue Shift:** A shift of an absorption maximum towards shorter wavelength or higher energy.

(v) **Hypochromic Effect:** An effect that results in decreased absorption intensity. (vi) **Hyperchromic Effect:** An effect that results in increased absorption intensity.

Applications of Electronic Spectroscopy in Predicting Absorption Maxima of Organic Molecules

1: Conjugated Dienes, Trienes and Polyenes

The presence of conjugate double bond decreases the energy difference between HOMO and LUMO of resulting diene. The figure 7 shows the change in energy of MO on conjugation. As a result, the radiations of longer wavelength are absorbed. The conjugation not only results in bathochromic shift (longer wavelength) but also increases the intensity of absorption. As the number of conjugated double bonds is increased, the gap between highest occupied molecular orbital (HOMO) and lowest unoccupied molecular orbital (LUMO) is progressively lowered. Therefore, the increase in size of the conjugated system gradually shifts the absorption maximum (λ_{max}) to longer wavelength and also increases the absorption. For example, ethylene absorbs at 175 nm ($\epsilon = 1000$) and the conjugation in butadiene gives a strong absorption at longer wavelength at 230 nm and with higher intensity ($\epsilon = >1000$).

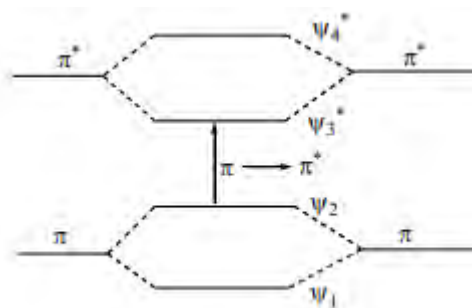

Figure 7: Effect of conjugation on orbitals' energy and respective π - π^* transition

The presence of alkyl substituents on double bond also produces bathochromic shift and hyperchromic effect. These effects are additive in dienes and up to some extent in trienes. The open chain dienes can achieve s-cis or s-trans conformations and similarly diene system can be homoannular

or heteroannular in cyclic systems. In 1941, Woodward suggested empirical rules for predicting the absorption of open chain and six-membered ring dienes which have been later on extended to large number of dienes and trienes.

As the number of double bonds in conjugation increases, the bathochromic (towards longer wavelength) shift in lowest energy absorption maxima is observed. The increase in conjugation gradually shifts the maxima to visible region (> 400 nm) and imparts colour to the sample. Table 4 shows the λ_{max} shift in $\text{Me}(\text{CH}=\text{CH})_n\text{Me}$ with increasing number of conjugated double bonds. β - Carotene (figure 8) responsible for red color in carrots is a typical example of polyene with 11 conjugated double bonds and exhibits λ_{max} at 445 nm.

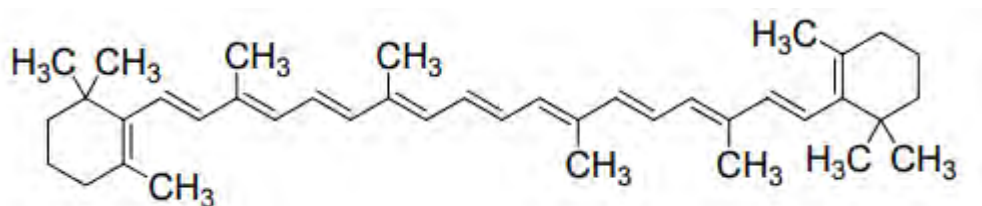

Figure 8: Structure of β -carotene

Table 4:

λ_{max} values for $\text{Me}(\text{CH}=\text{CH})_n\text{Me}$

n	Wavelength (nm)
3	275
4	310
5	342
6	380
7	407

2: Carbonyl Compounds

Carbonyl compounds have two principal UV radiations, the allowed $\pi \rightarrow \pi^*$ transitions and the forbidden $n \rightarrow \pi^*$ transitions. In amides, acids, esters or acid halides, the substituents viz. NR_2 , OH , OR , or $-\text{X}$ on carbonyl group show pronounced hypsochromic effect on the $n \rightarrow \pi^*$ transitions. The hypsochromic effect is due to inductive effect of nitrogen, oxygen or halogen atoms. The heteroatom withdraws electrons from carbonyl carbon and makes carbonyl oxygen lone pair of electrons more stabilized due to its involvement in increasing $\text{C}=\text{O}$ bond order. As a result, the $n \rightarrow \pi^*$ transition of these compounds is shifted to 200-215 nm range relative to 270 nm in aldehydes and ketones. Conjugation of the carbonyl group with double bond shifts both $n \rightarrow \pi^*$ and $\pi \rightarrow \pi^*$ transitions to longer wavelengths. The effect on $\pi \rightarrow \pi^*$ band is more pronounced.

3. Aromatic Compounds

The simplest aromatic compound is benzene. It shows two primary bands at 184 ($\epsilon = 47,000$) and 202 ($\epsilon = 7400$) nm and a secondary fine structure band at 255 nm ($\epsilon = 230$ in cyclohexane). Substituents on the benzene ring also cause bathochromic and hypsochromic shifts of various peaks. Unlike dienes and unsaturated ketones, the effects of various substituents on the benzene ring are not predictable. However, qualitative understanding of the effects of substituents on the characteristics of UV-Vis spectrum can be considered by classifying the substituents into electron-donating and electron-withdrawing groups. (i) Effect of Substituents with Unshared Electrons: The non-bonding electrons increase the length of π -system through resonance and shift the primary and secondary absorption bands to longer wavelength. More is the availability of these non-bonding electrons, greater the shift will be. In addition, the presence of non-bonding electrons introduces the possibility of $n \rightarrow \pi^*$ transitions. If non-bonding electron is excited into the extended π^* chromophore, the atom from which it is removed becomes electron-deficient and the π -system of aromatic ring becomes electron rich. This situation causes a separation of charge in the molecule and such excited state is called a charge-transfer or an electron-transfer excited state. In going from benzene to t-butylphenol, the primary absorption band at 203.5 nm shifts to 220 nm and secondary absorption band at 254 nm shifts to 275 nm. Further, the increased availability of n electrons in negatively charged t-butylphenoxide ion shifts the primary band from 203.5 to 236 nm (a 32.5 nm shift) and secondary band shifts from 254 nm to 290 nm (a 36 nm shift) (Figure 9). Both bands show hyperchromic effect. On the other hand, in the case of anilinium cation, there are no n electrons for interaction and absorption properties are quite close to benzene. But in aniline, the primary band is shifted to 232 nm from 204 nm in anilinium cation and the secondary band is shifted to 285 nm from 254 nm (Figure 10).

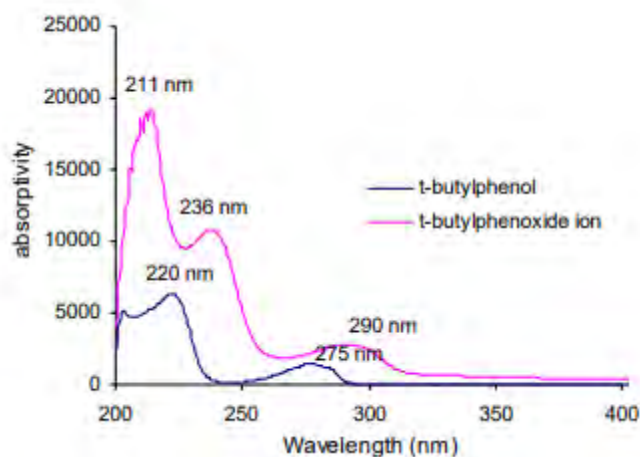

Figure 9: UV-spectra of t-butyl phenol and t-butyl phenoxide in methanol

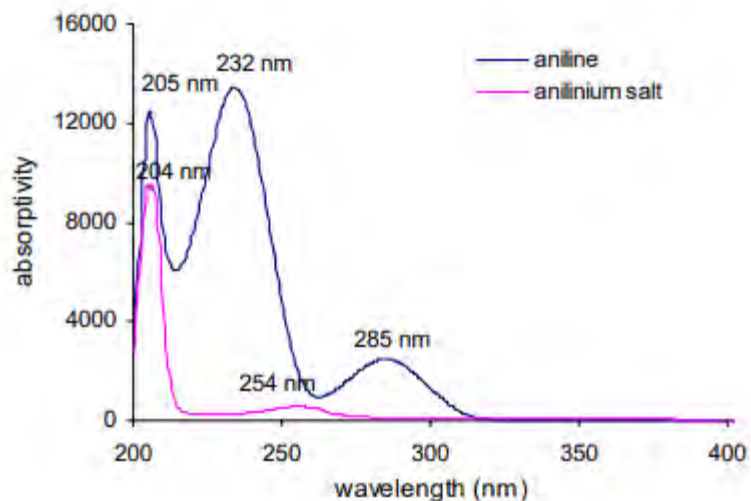

Figure 10 : UV-spectra of aniline and anilinium salt in methanol

(ii) **Effect of π Conjugation:** Conjugation of the benzene ring also shifts the primary band at 203.5 nm more effectively to longer wavelength and secondary band at 254 nm is shifted to longer wavelength to lesser extent. In some cases, the primary band overtakes the secondary band. For example, benzoic acid shows primary band at 250 nm and secondary band at 273 nm, but cinnamic acid that has longer chromophore exhibits primary band at 273 nm and secondary band remains merged with it. Similarly, in benzaldehyde, the secondary band appears at 282 nm and primary band at 242 nm but in case of cinnamaldehyde, primary band appears at 281 nm and remains merged with secondary band (figure 11). The hyperchromic effect arising due to extended conjugation is also visible.

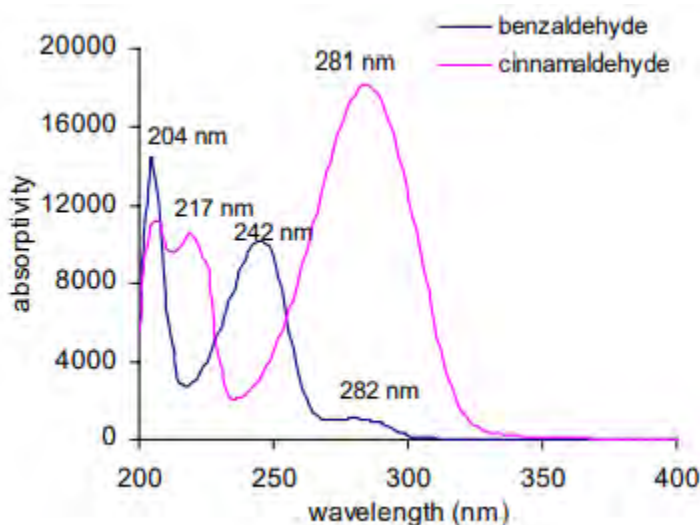

Figure 11: UV-spectra of benzaldehyde and cinnamaldehyde in methanol

(iii) Effect of Electron-withdrawing and Electron-releasing Groups: Electron-withdrawing substituents viz. NH_3^+ , SO_2NH_2 , CN , COOH , COCH_3 , CHO and NO_2 etc. have no effect on the position of secondary absorption band of benzene ring. But their conjugation effects with π electrons of the aromatic ring are observed. Electron-donating groups such as $-\text{CH}_3$, $-\text{Cl}$, $-\text{Br}$, $-\text{OH}$, $-\text{OCH}_3$, $-\text{NH}_2$ etc increase both λ_{max} and ϵ_{max} values of the secondary band.

In case of disubstituted benzene derivatives, it is essential to consider the effect of both the substituents. In para-substituted benzenes, two possibilities exist. If both the groups are electron-donating then the observed spectrum is closer to monosubstituted benzene. The group with stronger effect determines the extent of shifting of primary band. If one group is electron-releasing and other is electron-withdrawing, the magnitude of red shift is greater compared to the effect of single substituent individually. This is attributed to the increased electron drift from electron-donating group to the electron-withdrawing group through π -bond of benzene ring. For example, aniline shows secondary band at 285 nm which due to presence of electron-withdrawing p-nitro substituent is shifted to 367 nm with a significant increase in absorptivity (figure 12).

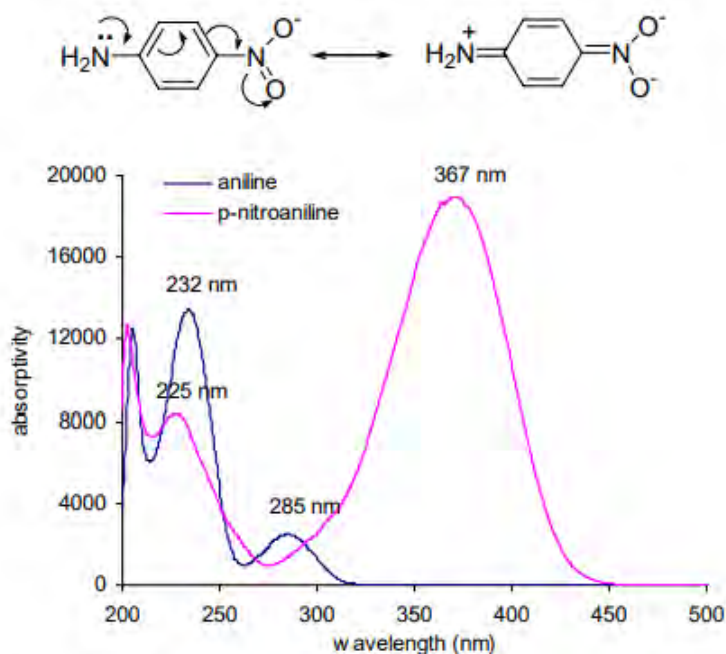

Figure 12: UV-spectra of aniline and p-nitroaniline in methanol

If two groups of a disubstituted benzene derivative are placed ortho- or meta- to each other, the combined effect of two substituents is observed. In case of substituted benzoyl derivatives, an empirical correction of structure with observed position of the primary absorption band has been developed. In the absence of steric hindrance to co-planarity, the calculated values are within ± 5 nm of the observed value.

(iv) Polycyclic Aromatic Compounds: In case of polycyclic aromatic hydrocarbons, due to extended conjugation, both primary and secondary bands are shifted to longer wavelength. These

spectra are usually complicated but are characteristic of parent compound. The primary band at 184 nm in benzene shifts to 220 nm in case of naphthalene and 260 nm in case of anthracene.

Similarly, the structured secondary band which appears as broad band around 255 nm in benzene is shifted to 270 nm and 340 nm respectively in case of naphthalene and anthracene molecules.

Commercial Applications of UV and Visible Spectroscopy

The UV-Vis spectroscopy has innumerable applications in the drugs and pharmaceutical industry. Beer-Lambert law offers a valuable and simple method for quantitative analysis. In practice, a calibration curve is constructed by plotting absorbance vs. molar concentration and the concentration of unknown with 'X' absorbance is determined by finding the concentration corresponding to the measured absorbance on the calibration curve. The UV spectroscopy is used extensively in determining rate constants, equilibrium constants, acid-base dissociation constants etc for chemical reactions. The use of UV spectrometry in evaluation of enzymatic assays has become very common e.g. the activity of enzyme dehydrase is assayed by measuring the formation of ergosterol at 282 nm.

Infrared Spectroscopy (Vibrational spectroscopy)

The two atoms joined together by a chemical bond (may be single, double or triple bond), macroscopically can be composed as two balls joined by a spring. The application of a force like (i) stretching of one or both the balls (atoms) away from each other or closer to each other (ii) bending of one of the atoms either vertically or horizontally and then release of the force results in the vibrations on the two balls (atoms). These vibrations depend on the strength of the spring and also the mode (stretching or bending) in which the force is being applied. Similarly, at ordinary temperatures, organic molecules are in a constant state of vibrations, each bond having its characteristic stretching and bending frequencies. When infrared light radiations between $4000\text{--}400\text{ cm}^{-1}$ (the region most concerned to an organic chemist) are passed through a sample of an organic compound, some of these radiations are absorbed by the sample and are converted into energy of molecular vibrations. The other radiations which do not interact with the sample are transmitted through the sample without being absorbed. The plot of % transmittance against frequency is called the infrared spectrum of the sample or compound. This study of vibrations of bonds between different atoms and varied multiplicities which depending on the electronegativity, masses of the atom and their geometry vibrate at different but specified frequencies; is called infrared spectroscopy. The presence of such characteristic vibrational bands in an infrared spectrum indicates the presence of these bonds in the sample under investigation.

Hooke's law and Absorption of radiations The band positions in the IR spectrum are presented in wave numbers (ν) whose unit is the reciprocal centimeter (cm^{-1}). ν is proportional to the energy of vibration. $\Delta E = h\nu = hc / \lambda = hc \nu$ Therefore, in principle, each absorption of radiation in the infrared region is quantized and should appear as sharp line. However, each vibrational transition within the molecule is associated with number of rotational energy changes and thus appears as combination of vibrational-rotational bands. The analogy of a chemical bond with two atoms linked through a spring can be used to rationalize several features of the infrared spectroscopy. The approximation to vibration frequency of a bond can be made by the application of Hooke's law. In Hooke's law, two atoms and their connecting bond are treated as a simple harmonic oscillator composed of two masses joined by a spring and frequency of vibration is stated as

$$\bar{\nu} \propto \sqrt{\frac{\text{bond strength}}{\text{mass}}}$$

$$\text{then } \bar{\nu} = \frac{1}{2\pi c} \sqrt{\frac{K}{(m_1 m_2) / (m_1 + m_2)}} \quad \text{----- eq. 1}$$

Where $\bar{\nu}$ = the vibrational frequency (cm^{-1})

c = velocity of light (cm/s)

K = force constant of the bond (dyne/cm)

m_1 and m_2 = masses of the two atoms

The quantity $(m_1 m_2) / (m_1 + m_2)$ is often expressed as μ , the reduced mass of the system.

$$\therefore \bar{\nu} = \frac{1}{2\pi c} \sqrt{\frac{K}{\mu}} \quad \text{----- eq. 2}$$

Since, according to equation 2

$$\bar{\nu} \propto \sqrt{K}$$

Therefore, the vibrational frequency of a bond would increase with the increase in bond strength. Consequently, we can expect that C=C and C=O stretching will have higher frequencies than C-C and C-O stretching, respectively.

$$\text{also } \bar{\nu} \propto \sqrt{\frac{1}{\mu}}$$

Therefore, the vibrational frequency of a bond would increase with the decrease in reduced mass of the system. It implies that C-H and O-H stretching absorptions should appear at higher frequencies than C-C and C-O stretching frequencies. Similarly, O-H stretching should appear at higher frequency than O-D stretching. Further, in parallel with the general knowledge that the stretching of the spring requires more energy than to bend it, the stretching absorption of a band always appear at higher energy than the bending absorption of the same band. The Hooke's law can be used to theoretically calculate the approximate stretching frequency of a bond. The value of K is approximately 5×10^5 dyne/cm for single bonds and approximately two and three times this value for the double and triple bonds, respectively.

Let us calculate the approximate frequency of the C-H stretching vibration from the masses of carbon and hydrogen

$$m_C = \text{mass of carbon atom} = 20 \times 10^{-24} \text{ g}$$

$$m_H = \text{mass of hydrogen atom} = 1.6 \times 10^{-24} \text{ g}$$

$$\therefore \bar{\nu} = \frac{7}{2 \times 22} \times \frac{1}{3 \times 10^8} \sqrt{\frac{5 \times 10^5}{(20 \times 10^{-24})(1.6 \times 10^{-24}) / (2.0 + 1.6)10^{-24}}}$$

$$= \sim 3100 \text{ cm}^{-1}$$

Let us consider how the radiations are being absorbed. We know that at ordinary temperature, molecules are in constant state of vibrations. The change in dipole moment during vibration of the molecule produces a stationary alternating electric field. When the frequency of incident electromagnetic radiations is equal to the alternating electric field produced by changes in the dipole moment, the radiation is absorbed and vibrational levels of the molecule are excited. Once in the vibrationally excited state, the molecules can lose the extra energy by rotational, collision or translational processes etc. and come back to ground state. Therefore, only those vibrations which result in a rhythmic change in the dipole moment of the molecule absorb infrared radiations and are defined as IR active. The others which do not undergo change in dipole moment of the molecule are IR inactive e.g. the stretching of a symmetrically substituted bond, viz 'carbon triple bond carbon' in acetylene and symmetrical stretching in carbon dioxide (figure 2) – a linear molecule, produce no change in the dipole moment of the system and these vibrations cannot interact with infrared light and are IR inactive. In general, the functional groups that have a strong dipole give rise to strong absorption bands in the IR.

Modes of molecular vibrations

Molecules with large number of atoms possess a large number of vibrational frequencies. For a non-linear molecule with n atoms, the number of fundamental vibrational modes is (3n-6); linear molecules have 3n-5 fundamental vibrational modes. Therefore, water - a non-linear molecule theoretically possesses 3 fundamental vibrations – two stretching and one bending (figure 1); whereas carbon dioxide - a linear molecule possess four(4) fundamental absorption bands involving two stretching and two bending modes (figure 2). Amongst these theoretically possible vibrations, a stretching vibration is a rhythmic movement along the bond axis such that interatomic distance is increasing or decreasing. A bending vibration consists of a change in bond angle between bonds with a common atom or the movement of a group of atoms with respect to remaining part of the molecule without movement of the atoms in the group with respect to one another.

STRECHING MODE

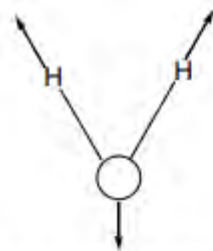

Symmetric stretching

BENDING MODE

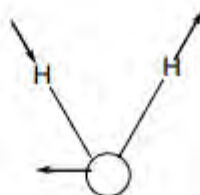

Asymmetric stretching

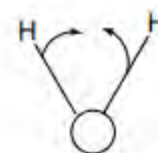

scissoring

Figure 1: Vibrational modes for water molecule

STRECHING MODE



Symmetrical

ν_s

(IR inactive)

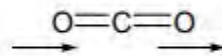

Asymmetrical

ν_{as}

BENDING MODE

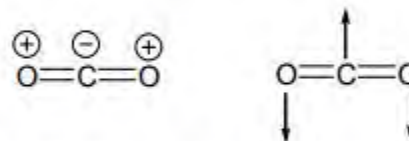

The vibrations are at same frequency and are doubly degenerate

Figure 2: Vibrational modes for carbon dioxide molecule

The various stretching and bending modes can be represented by considering an AX₂ group appearing as a portion of molecule, for example, the CH₂ group in a hydrocarbon molecule (figure 3). Any atom joined to two other atoms will undergo comparable vibrations for example NH₂ or NO₂. Each of different vibration modes may give rise to a different absorption band so that CH₂ groups give rise to two C-H stretching bands i.e. ν_{sym} and $\nu_{antisym}$. Some of the vibrations may have the same frequency i.e. they are degenerate and their absorption bands will appear at same position (for CO₂, see figure 2).

BENDING VIBRATIONS

In-plane-bending

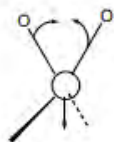

scissoring (ν_{as} CH₂)
~ 1465 cm⁻¹

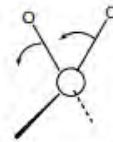

rocking (ν_s CH₂)
~ 720 cm⁻¹

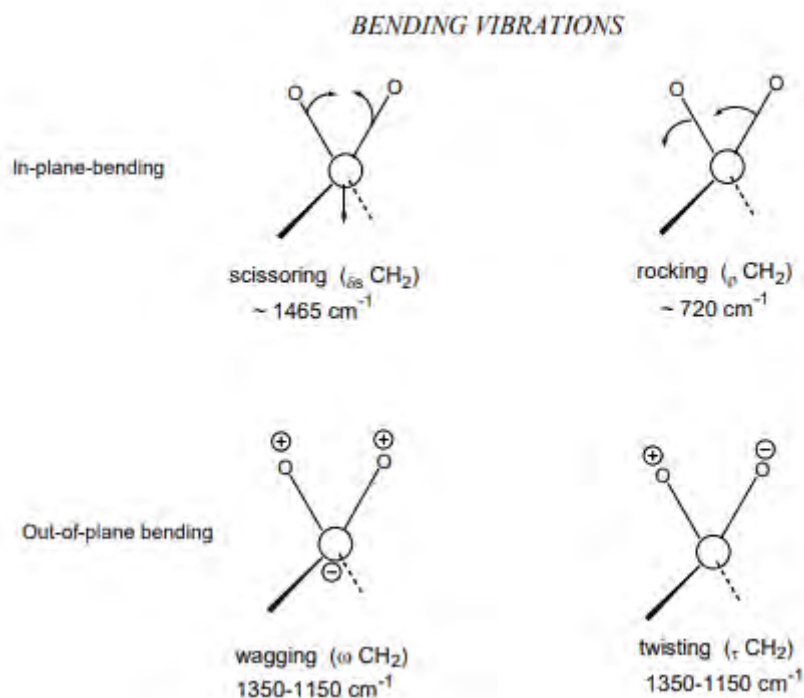

Figure 3: Vibrational modes of a CH₂ group. [plus and minus indicate movement above and below the plane of page]

In addition to the fundamental vibrations, other frequencies can be generated by modulations of the fundamental bands. Overtone bands appear at integral multiples of fundamental vibrations. Therefore, the strong absorptions at say 800 cm⁻¹ and 1750 cm⁻¹ will also give rise to weaker absorptions at 1600 cm⁻¹ and 3500 cm⁻¹, respectively. In the IR spectra of benzaldehyde (figure 17) and acetophenone (figure 18), due to C=O stretching vibration a weak overtone can be seen at 3400 and 3365 cm⁻¹, respectively. Two frequencies may interact to give beats which are combination or difference frequencies. The absorptions at x cm⁻¹ and y cm⁻¹ interact to produce two weaker beat frequencies at x + y cm⁻¹ and x - y cm⁻¹. Therefore, whereas the factors like degeneracy of bands from several absorptions of the same frequency, lack of change in molecular dipole moment during vibration and fall of frequencies outside the 4000-400 cm⁻¹ region decrease the number of bands whereas the overtone and beats increase the number of bands actually appeared in IR spectrum. Therefore, theoretical numbers of fundamental frequencies are seldom observed. Other Factors Influencing Vibrational Frequencies The vibrational frequency of a bond, being part of a molecule, is significantly affected by the electronic and steric factors of the surroundings, in addition to the bond strength and atomic masses discussed above. When two bond oscillators share a common atom, they seldom behave as individual oscillators where the individual oscillation frequencies are widely different. The mechanical coupling interactions between two oscillators are responsible for these changes.

For example, the carbon dioxide molecule, which consists of two C=O bonds with a common carbon atom, has two fundamental stretching vibrations – an asymmetrical and a symmetrical stretching

mode. The symmetrical stretching mode produces no change in dipole moment and is IR inactive. Asymmetric stretching mode is IR active and appears at a higher frequency (2350 cm^{-1}) than observed for a carbonyl group in aliphatic ketones (1715 cm^{-1}). The carbonyl stretching frequency in RCOCH_3 ($\sim 1720\text{ cm}^{-1}$) is lower than acid chloride RCOCl ($1750\text{--}1820\text{ cm}^{-1}$). This change in frequency of the $\text{C}=\text{O}$ stretching may be arising due to (i) difference in mass between CH_3 and Cl (ii) the inductive or mesomeric influence of Cl on the $\text{C}=\text{O}$ bond (iii) coupling interactions between $\text{C}=\text{O}$ and $\text{C}-\text{Cl}$ bonds (iv) change in bond angles arising due to steric factors etc. It is usually impossible to isolate one effect from the other. However, the appropriate emphasis can be placed on those features that seem to be most responsible in explaining the characteristic appearance and position of group frequencies.

Characteristic Group Vibrations of Organic Molecules

An infrared spectrum of an organic compound comprises many bands and assigning each band to a particular mode of vibration is practically impossible but two non-identical molecules generally have different IR spectra. An IR spectrum, therefore, is a fingerprint of the molecule. The region most useful for the purpose of “fingerprinting” of the compound is $650\text{--}1350\text{ cm}^{-1}$. This region comprises a large number of bands due to skeletal vibrations and when the spectrum we are studying coincides exactly with the spectrum of a known compound, it can be safely assumed that the two compounds are identical. The region above 1350 cm^{-1} often provides easily recognizable bands of various functional groups and thus much valuable structural evidence from relatively few of these bands is obtained and total interpretation of the complete spectrum is seldom required. In the following sections, the basic information about the vibrational modes in basic functional groups has been discussed.

1. Hydrocarbons C-H and C-C stretching and bending vibrations

(i) Alkanes: In simple hydrocarbons, only two types of atoms - C and H and only two types of bonds – C-C and C-H are present. The C-H stretching vibrations usually occur in the general region between 3300 cm^{-1} (in alkynes) and 2700 cm^{-1} (in aldehydes).

A hydrocarbon containing a methyl group usually shows two distinct bands, one at 2960 cm^{-1} due to asymmetric stretching and the other at 2870 cm^{-1} due to symmetric stretching. The C-H bonds in methylene group undergo number of stretching and bending vibrations as shown in figure 3. The two stretching vibrations – asymmetrical and symmetrical occur at 2925 cm^{-1} and appear in the spectrum within a range of $\pm 10\text{ cm}^{-1}$.

The C-H bending vibrations of the methyl groups in the hydrocarbons normally occur at 1450 and 1375 cm^{-1} . The band at 1375 cm^{-1} is due to methyl on the carbon atom and is quite sensitive to the electronegativity of the substituent present at the methyl group. It shifts from as high as 1475 cm^{-1} in $\text{CH}_3\text{-F}$ to as low as 1150 cm^{-1} in $\text{CH}_3\text{-Br}$. However, this band is extremely useful in detecting the presence of methyl group in a compound because it is sharp and of medium intensity and is rarely overlapped by absorptions due to methylene or methine deformations. The intensity of this band usually increases with the number of methyl groups in the compound. However, the presence of two or more methyl

groups on one aliphatic carbon atom (isopropyl or t-butyl groups) results in splitting of this band due to in-phase or out-of phase interactions of the two symmetrical methyl deformations.

In case of methylene group, C-H bending vibrations such as scissoring, twisting, wagging and rocking normally appear at fairly different frequencies. If two or more CH₂ groups are present, the usually strong scissoring and rocking absorption bands appear at 1465 and 720 cm⁻¹, respectively. Whereas weak bands due to twisting and wagging vibrations appear at 1250 + 100 cm⁻¹. So, the scissoring absorption band of methylene around 1465 cm⁻¹ often overlaps with asymmetric bending vibration of methyl at 1450 cm⁻¹.

In cyclic aliphatic hydrocarbons, the C-H stretching frequencies are the same (2800 – 3000 cm⁻¹) as in the case of acyclic compounds, if the ring is unstrained. However, methylene scissoring bands shift slightly to smaller wavenumber (1470 cm⁻¹ in hexane and 1448 cm⁻¹ in cyclohexane, see figure 4). In sterically strained cyclic compounds, the C-H stretching normally occurs at slightly higher wavenumber e.g. 3080 -3040 cm⁻¹ in cyclopropane.

The C-C bond vibrations appear as weak bands in 1200-800 cm⁻¹ region and are seldom used for structural study. Whereas the C-C bending absorptions occur at < 500 cm⁻¹ and are usually below the range of IR – instrument.

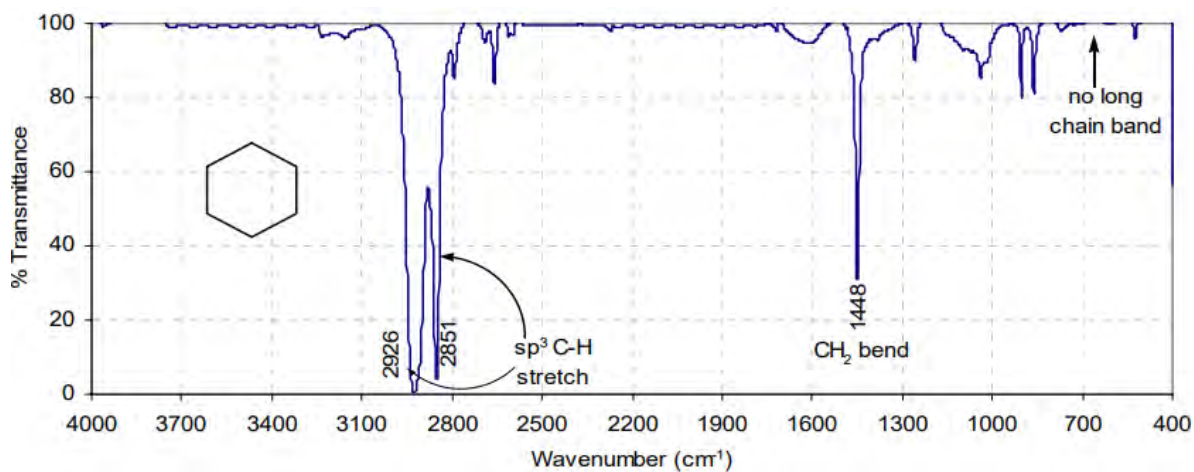

Figure 4: The infrared spectrum of cyclohexane (neat liquid)

(ii) Alkenes: The carbon-carbon double bond has a higher force constant than a C-C single bond and in a non-conjugated olefin, C=C stretching vibrations appear at higher frequency (1680-1620 cm⁻¹) than that of the C-C stretching vibrations (1200-800 cm⁻¹).

In completely symmetrical alkenes, such as ethylene, tetrachloroethylene etc., C=C stretching band is absent, due to lack of change in dipole moment in completely symmetrical molecule. On the other hand, non-symmetrically substituted double bonds exhibit strong absorption bands. The absorption bands are more intense for cis isomers than for trans isomers; for mono or tri substituted olefins than for di and tetra substituted ones. Also, terminal olefins show stronger C=C double bond stretching vibrations than internal double bonds. Similarly C=C groups conjugated with certain

unsaturated group show stronger band than for non-conjugated ones. In case of olefins, conjugated with an aromatic ring, the C=C stretching appears at 1625 cm^{-1} (s) and an additional band at $\sim 1600\text{ cm}^{-1}$ is observed due to aromatic double bond. In compounds containing both olefinic and alkyl C-H bonds, the bands above 3000 cm^{-1} are generally attributed to aromatic or aliphatic C-H stretching, whereas between $3000\text{-}2840\text{ cm}^{-1}$ are generally assigned to the alkyl C-H stretching. The absorption frequency of a double bond in a cyclic ring is very sensitive to ring size (figure 5). The absorption frequency decreases as the internal angle decreases and is lowest in cyclobutene (90° angle). The frequency increases again for cyclopropane.

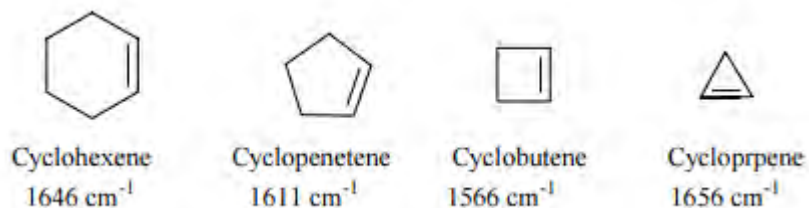

Figure 5: C=C vibration frequencies of cycloalkenes

The exocyclic double bonds exhibit an increase in frequency with decrease in ring size (figure 6). The exocyclic double bond on six-membered ring absorbs at 1651 cm^{-1} and it is shifted to 1780 cm^{-1} in case of exocyclic double bond on cyclopropane. The allenes show the highest double bond absorptions at 1940 cm^{-1} .

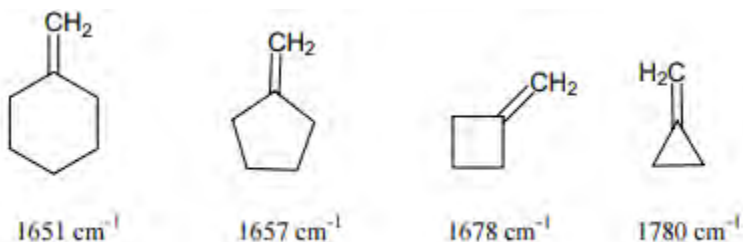

Figure 6: Exocyclic C=C double bond frequencies in various ring sizes

(iii) Alkynes : All alkynes both terminal ($\text{R.C}\equiv\text{CH}$) or non-terminal ($\text{R.C}\equiv\text{CR}$) contain carbon – carbon triple bond but the non-terminal alkynes also contain a $\equiv\text{CH}$ bond. The force constant for a triple bond is greater than that for a double bond. Consequently, whereas a C-C stretching vibrations occur between $1300\text{-}800\text{ cm}^{-1}$ and the C=C stretching vibration occur in the region $1700\text{-}1500\text{ cm}^{-1}$, the $\text{C}\equiv\text{C}$ vibrations are observed at significantly higher frequencies in the region of $2300\text{ to }2050\text{ cm}^{-1}$. The terminal alkynes show weak triple bond stretching vibration at $2140\text{-}2050\text{ cm}^{-1}$, whereas the unsymmetrically disubstituted alkynes show a triple bond absorption at $2260\text{-}2190\text{ cm}^{-1}$. The acetylene C-H stretching vibrations are normally observed as a sharp characteristic band in the region $3310\text{-}3200\text{ cm}^{-1}$ and the acetylenic C-H bending vibrations occur in the region $600\text{-}650\text{ cm}^{-1}$. Therefore the frequency of the

absorption of C-H bond is a function of the type of hybridization of the carbon to which hydrogen atom is attached. While moving from sp^3 to sp^2 and sp hybridized carbons, the s-character increases and so is the bond strength (force constant of C-H bond and the frequency of absorption (Table 7).

Table 7:

<i>Important C-H stretching vibrations at a glance</i>			
	<i>Vibration</i>	<i>Frequency (cm⁻¹)</i>	<i>Intensity</i>
Alkane	Stretch	3000-2850	s
Methyl	bending	1450-1375	m
Methylene	bending	1465	m
Alkene	stretch	3100-3000	m
	bend	1000-650	s
Aromatic	stretch	3150-3000	s
	bend	900-690	s
Alkyne	stretch	3300	s
Aldehyde		2980-2800	w
		2800-2700	w

(iv) Aromatic Hydrocarbons: In the aromatic compounds, the most prominent bands are due to out-of-plane bending of ring C-H bonds in the region of 900-650 cm^{-1} . These bands can be used to assign the ring substitution pattern in mono substituted benzenes and 1,2-, 1,3-, and 1,4- substituted benzene derivatives. Mono substituted benzene derivatives exhibit strong absorption band near 690 cm^{-1} (see IR spectrum of toluene, figure 7). The absence of this band indicates the absence of mono substituted phenyl rings in the sample. A second strong band appears at $\sim 750\text{ cm}^{-1}$. 1,2-Disubstituted benzenes give one strong absorption band at $\sim 750\text{ cm}^{-1}$. 1,3- Disubstituted rings give three absorption bands at ~ 690 , ~ 780 and $\sim 880\text{ cm}^{-1}$. 1,4-Disubstituted rings give one strong absorption band in the region 800-850 cm^{-1} (strong absorption band at 831 cm^{-1} is seen in IR spectrum of t-butylphenol, figure 11). The spectra of aromatic compounds typically exhibit many weak or medium intensity C-H stretching vibrations in the region 3100- 3030 cm^{-1} , the region of olefinic compounds.

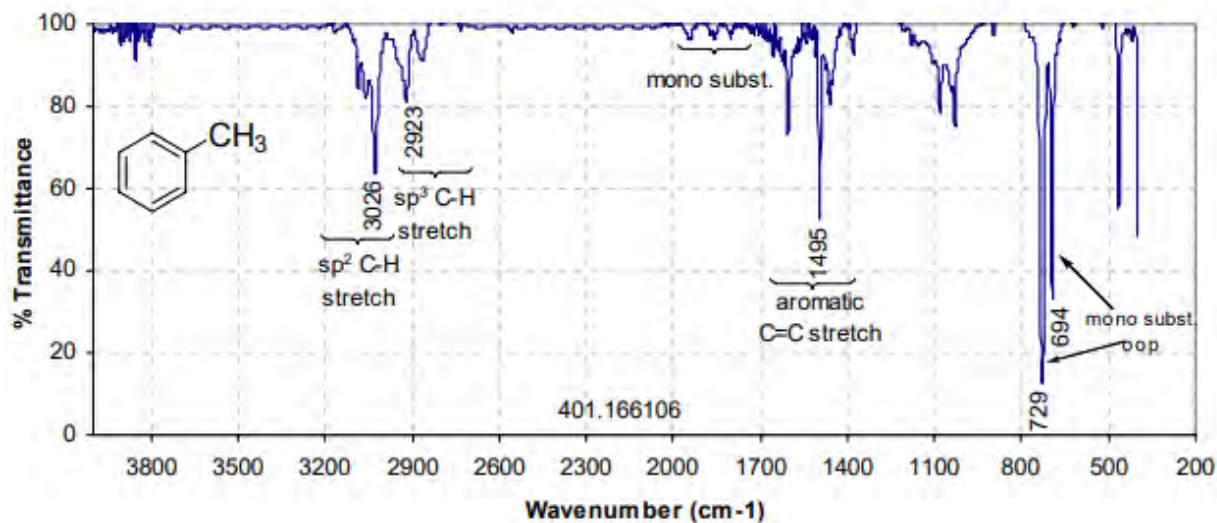

Figure 7: The infrared spectrum of toluene (neat liquid)

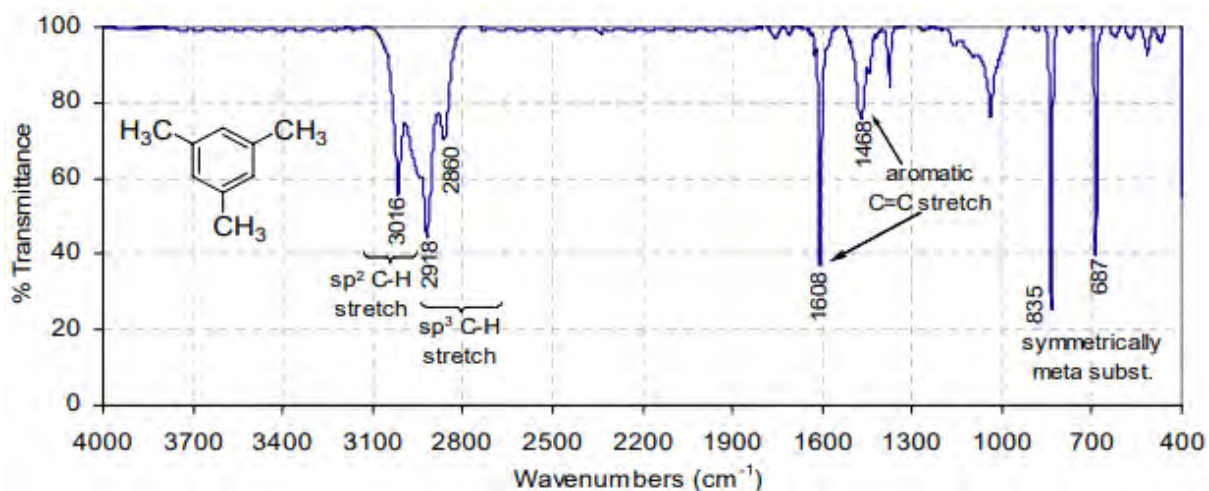

Figure 8: The infrared spectrum of mesitylene (neat liquid)

The bands considered to be of most help in diagnosing the aromatic character of the compound appear in the region $1650\text{-}1400\text{ cm}^{-1}$. There are normally four bands in this region at about 1600 , 1585 , 1500 and 1450 cm^{-1} and are due to C=C in-plane vibrations (see spectra in figures 7 and 8). The combination and overtone bands in $2000\text{-}1650\text{ cm}^{-1}$ region are also characteristics of aromatic rings. Moreover, they are very weak and are observed only in the case of concentrated solutions of highly symmetric benzene derivatives.

2. Alcohols and Phenols

When a hydrogen atom from an aliphatic hydrocarbon is replaced by an OH group, new bands corresponding to new OH and C-O band absorption appear in the IR spectrum. A medium to strong absorption band from 3700 to 3400 cm^{-1} (see IR spectra of 1-butanol and t-butylphenol in figures 25 and 26) is a strong indication that the sample is an alcohol or phenol (The presence of NH or moisture causes similar results). The exact position and shape of this band depends largely on the degree of H-bonding. A strong, sharp peak in the region as higher 3700 cm^{-1} in gaseous or extremely dilute solutions represents unbounded or free OH group(s). Alcohols and phenols in condensed phases (bulk liquid, KBr discs, concentrated solution etc.) are strongly hydrogen bonded, usually in the form of dynamic polymeric association; dimers, trimers, tetramers etc. (Figure 9) and cause broadened bands at lower frequencies. The hydrogen bonding involves a lengthening of the original O-H bond. This bond is consequently weakened, force constant is reduced and so the stretching frequency is lowered.

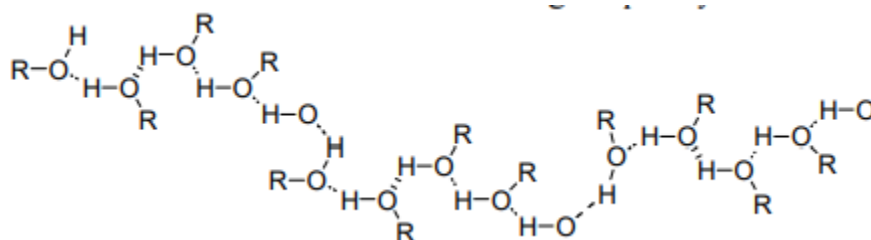

Figure 9: Polymeric association of ROH

The C-O stretching in phenols / alcohols occurs at a lower frequency range 1250-1000 cm^{-1} . The coupling of C-O absorption with adjacent C-C stretching mode, makes it possible to differentiate between primary ($\sim 1050 \text{ cm}^{-1}$), secondary ($\sim 1100 \text{ cm}^{-1}$) and tertiary ($\sim 1150 \text{ cm}^{-1}$) alcohols and phenols ($\sim 1220 \text{ cm}^{-1}$).

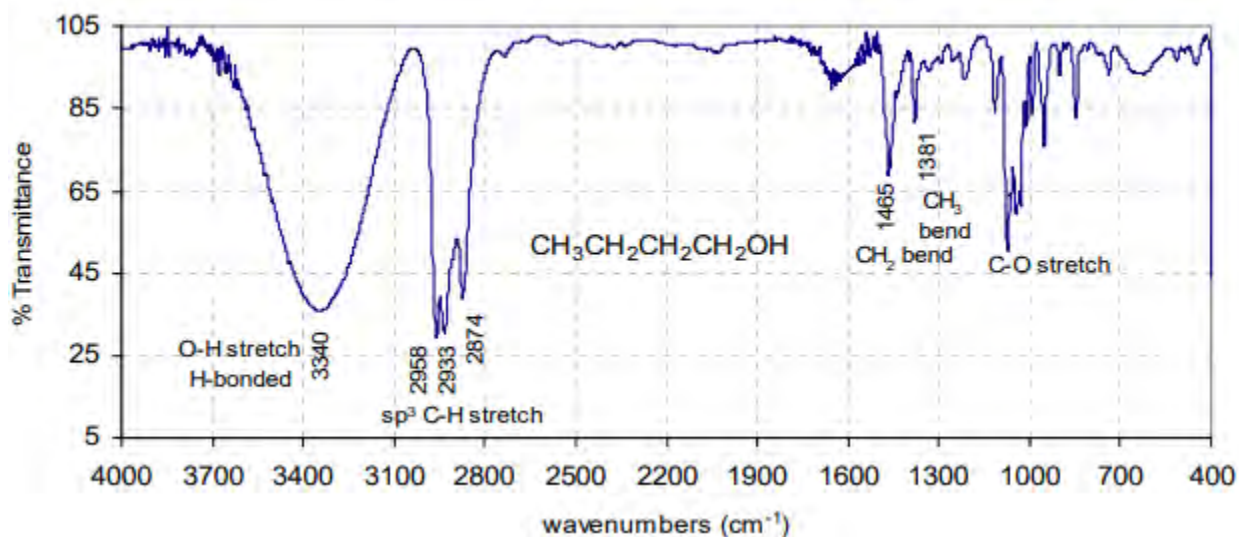

Figure 10: The infrared spectrum of 1-butanol (neat liquid)

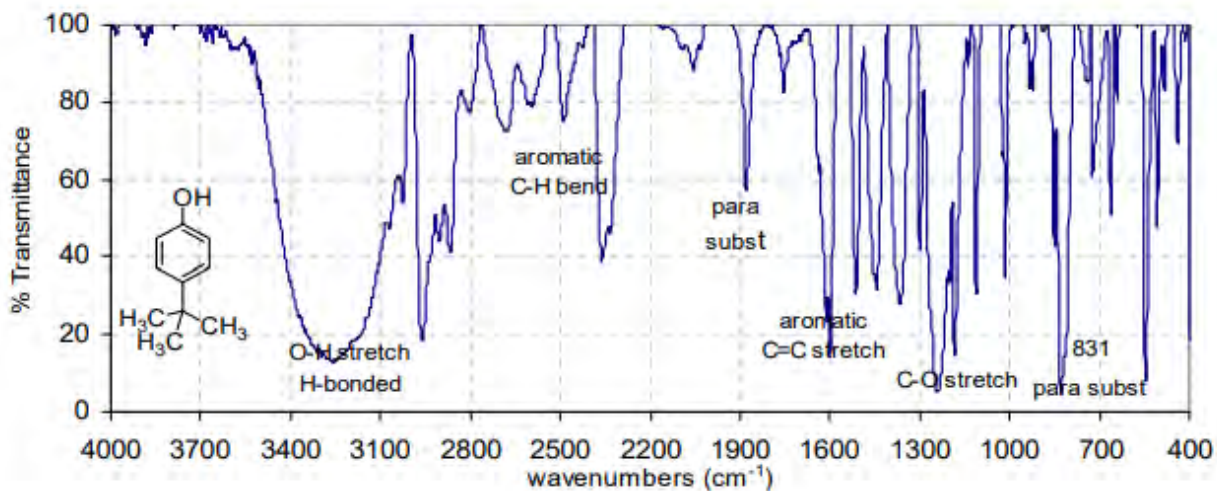

Figure 11: The infrared spectrum of t-butylphenol (nujol mull)

3. Carbonyl Compounds The absorption peak for C=O stretching in the region 1870 to 1600 cm^{-1} is perhaps the easiest band to recognize in IR spectrum and is extremely useful in analysis of carbonyl compounds. The changes in C=O stretching frequency in various carbonyl compounds viz. aldehydes, ketones, acids, esters, amides, acid halides, anhydrides etc. can be explained by considering (i) electronic and mass effects of neighboring substituents (ii) resonance effects (both C=C and heteroatom lone pair) (iii) hydrogen bonding (inter and intramolecular) (iv) ring strain etc. It is customary to refer to the absorption frequency of a saturated aliphatic ketone at 1715 cm^{-1} as normal value and changes in the environment of the carbonyl group can either lower or raise the absorption frequency from the “normal” value.

(i) Inductive and Resonance Effects: The replacement of an alkyl group of the saturated aliphatic ketone by a heteroatom (O, N) shifts the C=O stretching frequencies due to inductive and resonance effects. In esters, the oxygen due to inductive effect withdraws the electrons from carbonyl group (figure 12) and increases the C=O bond strength and thus the frequency of absorption. In amides, due to the conjugation of lone pair of electrons on nitrogen atom, the resonance effect increases the C=O bond length and reduces the C=O absorption frequency. Therefore, C=O absorption frequencies due to resonance effects in amides are lowered but due to inductive effect in esters are increased than those observed in ketones.

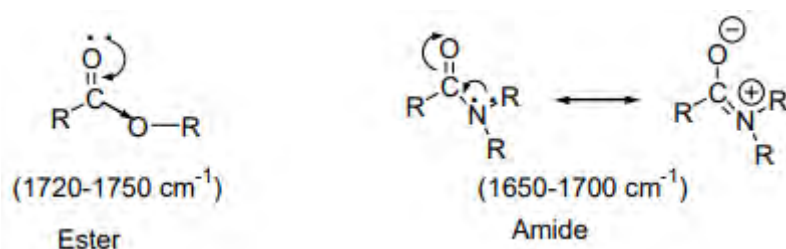

Figure 12: Inductive and resonance effects in ester and amide groups

In acid chlorides, the halogen atom strengthens the C=O bond through inductive effect and shifts the C=O stretching frequencies even higher than are found in esters. The acid anhydrides give two bands in C=O stretching frequency region due to symmetric ($\sim 1820\text{ cm}^{-1}$) and asymmetric ($\sim 1760\text{ cm}^{-1}$) stretching vibrations (figure 23).

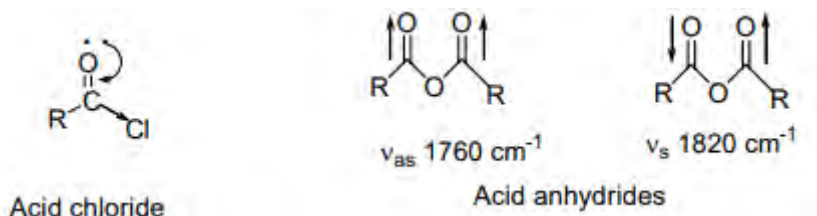

Figure 13: Inductive effect in acid chloride and C=O stretch in anhydride

(ii) Conjugation Effects: The C=O stretching frequencies for carbon-carbon double bond conjugated systems are generally lower by $25\text{-}45\text{ cm}^{-1}$ than those of corresponding nonconjugated compounds. The delocalization of π -electrons in the C=O and C=C bonds lead to partial double bond character in C=O and C=C bonds and lowers the force constant (figure 14). Greater is the ability of delocalization of electrons, the more is lowering in C=O stretching frequency. In general s-cis conformations absorb at higher frequency than s-trans conformations. A similar lowering in C=O stretching frequency occurs when an aryl ring is conjugated with carbonyl compound.

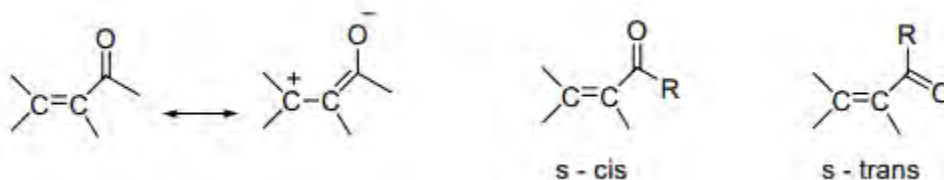

Figure 14: Resonance effects and s-cis and s-trans structures in enones

(iii) Ring Size Effects: Six-membered rings with carbonyl group e.g. cyclohexanone absorb at normal value i.e. 1715 cm^{-1} . Decrease in ring size increases the C=O stretching frequency. Smaller rings require the use of more p-character to make C-C bonds for the requisite small angles. This gives more s-character to the C=O sigma bond and thus results in strengthening of C=O double bond. The comparison of C=O stretching frequencies of various compounds in figure 15 shows that in ketones and esters, $\sim 30\text{ cm}^{-1}$ increase in frequency occurs on moving to one carbon lower ring.

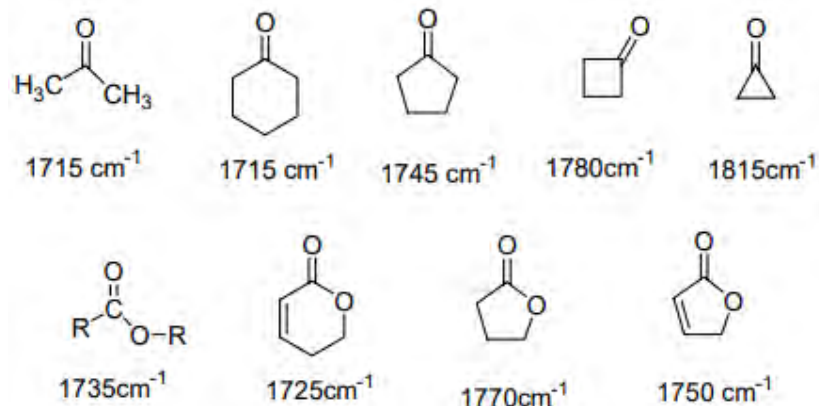

Figure 15: C=O stretching frequencies in various compounds

(iv) Hydrogen Bonding Effects: Hydrogen bonding to a C=O group withdraws electrons from oxygen and lowers the C=O double bond character. This results in lowering of C=O absorption frequency. More effective is the hydrogen bonding, higher will be the lowering in C=O absorption frequencies.

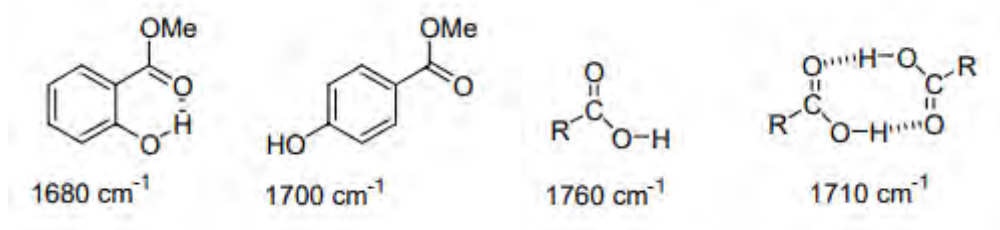

Figure 16: H-bonding effects on C=O stretch

The monomeric carboxylic acids (in very dilute solutions) absorb at $\sim 1760 \text{ cm}^{-1}$. The dimerization of carboxylic acids in their concentrated solutions or in solid state lowers the carboxyl carbonyl frequency to 1710 cm^{-1} . The more effective intramolecular hydrogen bonding in methyl salicylate lowers the C=O stretching frequency to 1680 cm^{-1} than observed at 1700 cm^{-1} in case of methyl p-hydroxybenzoate.

a. Aldehydes and Ketones

Aliphatic aldehydes show strong C=O stretching in the region of $1740 - 1725 \text{ cm}^{-1}$. The conjugation of an aldehyde to a C=C or a phenyl group lowers C=O stretching by $\sim 30 \text{ cm}^{-1}$. This effect is seen in benzaldehyde in which aryl group is attached directly to the carbonyl group and shifts C=O stretch to 1701 cm^{-1} (see IR spectrum of benzaldehyde, figure 17). Aldehyde C-H stretching vibrations appear as a pair of weak bands between $2860-2800$ and $2760-2700 \text{ cm}^{-1}$. The higher C-H stretching band ($2860-2800 \text{ cm}^{-1}$) of aldehyde is often buried under aliphatic CH band. But the lower C-H band at $2760-2700 \text{ cm}^{-1}$ is usually used to distinguish aldehydes from ketones. The C-H bending vibrations appear between $945-780 \text{ cm}^{-1}$.

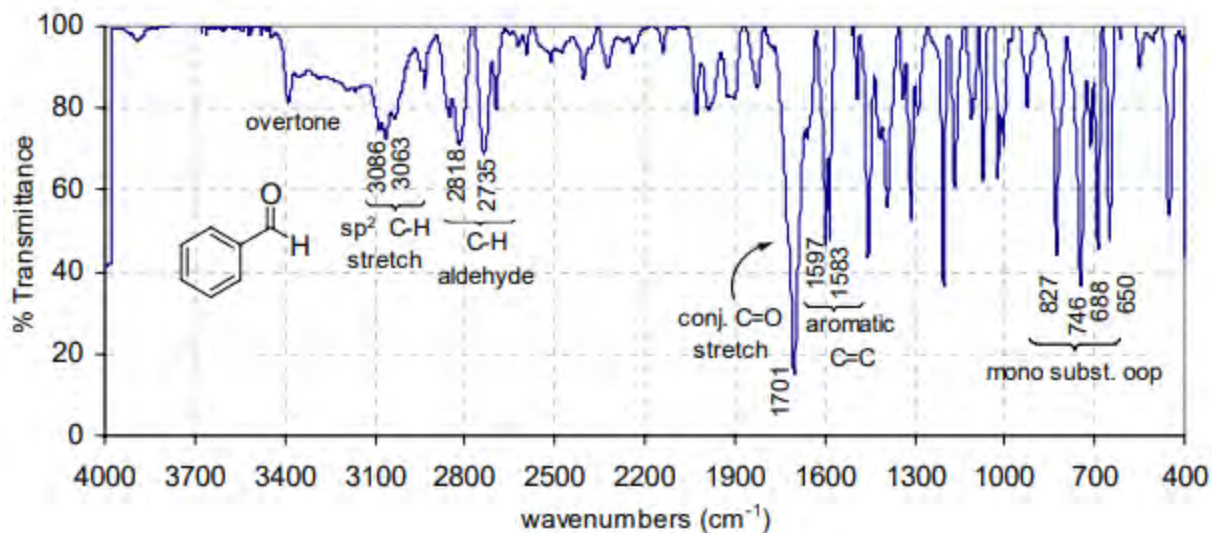

Figure 17: The infrared spectrum of benzaldehyde (neat liquid)

The aliphatic acyclic ketones show C=O stretching between 1720 to 1700 cm^{-1} which is shifted to lower frequencies by 20-30 cm^{-1} on conjugation with C=C or phenyl ring. The presence of two conjugated groups as in benzophenone further lowers the C=O stretching frequency to 1658 cm^{-1} (figures 18 and 19).

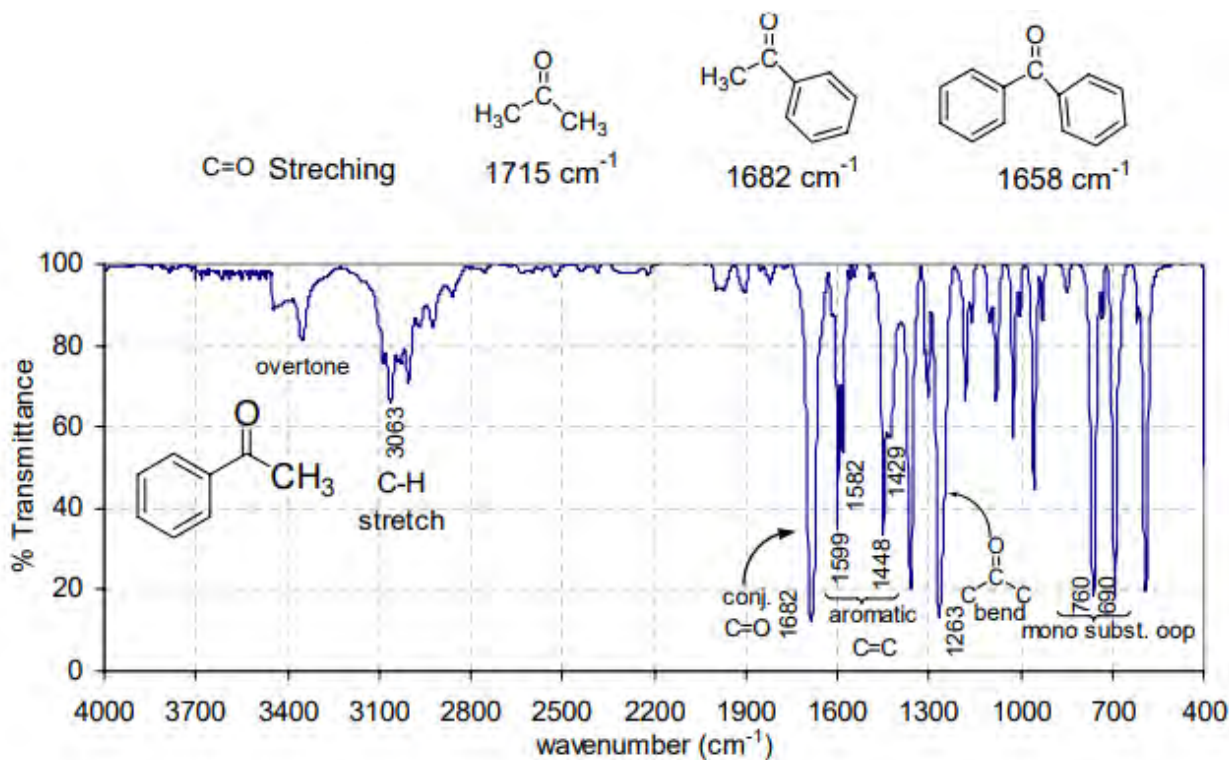

Figure 18: The infrared spectrum of acetophenone (neat liquid)

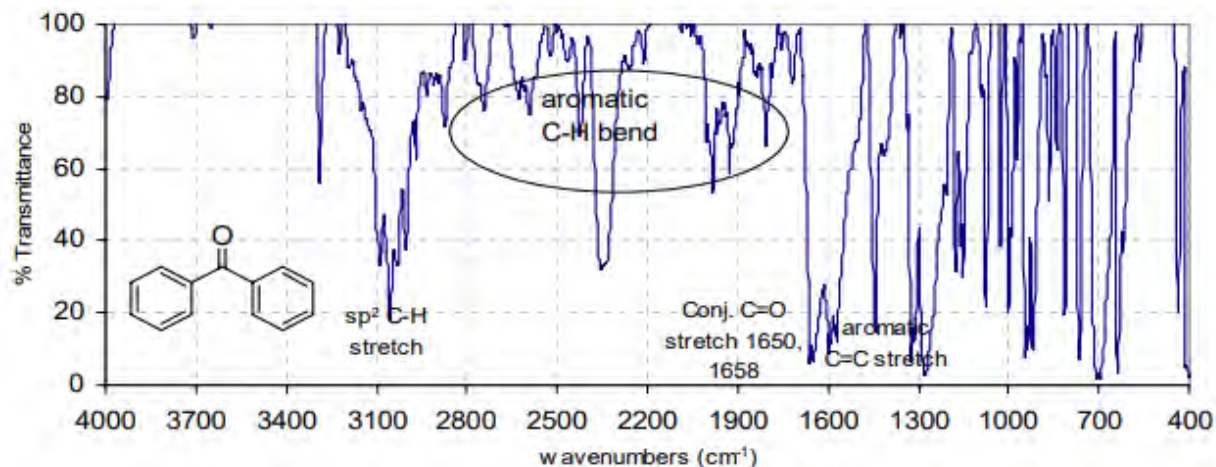

Figure 19: The infrared spectrum of benzophenone (nujol mull)

In case of cyclic ketones, the coupling between C=O stretching and C(=O)-C single bond causes increase in C=O stretching frequency as the C-C(=O) angle decreases (figure 15).

b. Carboxylic Acids, Esters and Carboxylates In case of carboxylic acids, in solid state or pure liquid state, the intermolecular hydrogen bonding weakens the C=O bond and thus lower the stretching frequency to $\sim 1720\text{ cm}^{-1}$. The O-H stretch appears as a very broad band between $3400 - 2500\text{ cm}^{-1}$ (see IR spectrum of benzoic acid, figure 20). The appearance of strong C=O stretching along with broad hydroxyl peak centered at $\sim 3000\text{ cm}^{-1}$ in an IR spectrum certainly shows the presence of carboxylic acid. In addition a medium intensity C=O stretch appears between $1320 - 1260\text{ cm}^{-1}$. In dilute solutions, the carboxylic acids attain monomeric structures and the inductive effect of oxygen shifts the C=O absorption band to higher values ($1760 - 1730\text{ cm}^{-1}$) than observed in ketones.

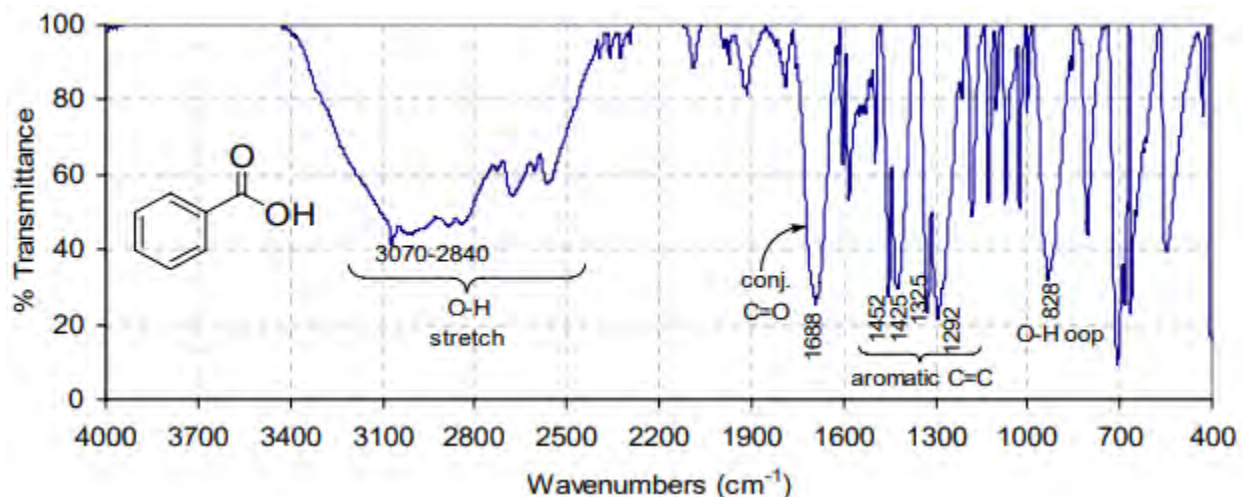

Figure 20: The infrared spectrum of benzoic acid (nujol mull)

In case of esters, the C=O stretching appears in the range 1750-1730 cm^{-1} and strong C-O stretching absorption appears in the range 1300 -1000 cm^{-1} . The esters of α,β -unsaturated or aryl carboxylic acids due to conjugation absorb at lower frequency (figure 21).

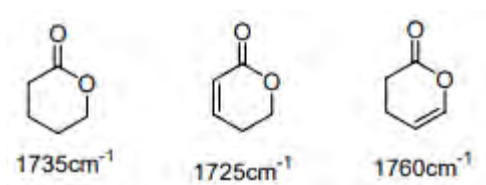

Figure 21: Effect of conjugation in cyclic esters

NMR SPECTROSCOPY

The 1952 Nobel Prize in Physics was awarded to Felix Bloch (Stanford) and Edward M. Purcell (Harvard) for their discoveries relating to nuclear magnetic resonance.

I. INTRODUCTION:

Nuclear magnetic resonance (NMR), a form of spectroscopy that is one of the most powerful tools for the identification of functional groups and for the determination of connections between the atoms in molecules, which requires for the structure determination of compounds. NMR spectroscopy is a study for interaction of energy with matter where energy absorption by molecules will quantitate that have been placed in a strong magnetic field.

The nuclei of certain elements, including ^1H nuclei (protons) and ^{13}C (carbon-13) nuclei, behave as though they were magnets spinning about an axis. When a compound containing protons or carbon-13 nuclei is placed in a very strong magnetic field and simultaneously irradiated with electromagnetic energy of the appropriate frequency, nuclei of the compound absorb energy through a process called magnetic resonance. The absorption of energy is quantized.

A graph that shows the characteristic energy absorption frequencies and intensities for a sample in a magnetic field is called a **nuclear magnetic resonance (NMR) spectrum (Figure 1)**.

Example: The proton (^1H) NMR spectrum of bromoethane is shown below.

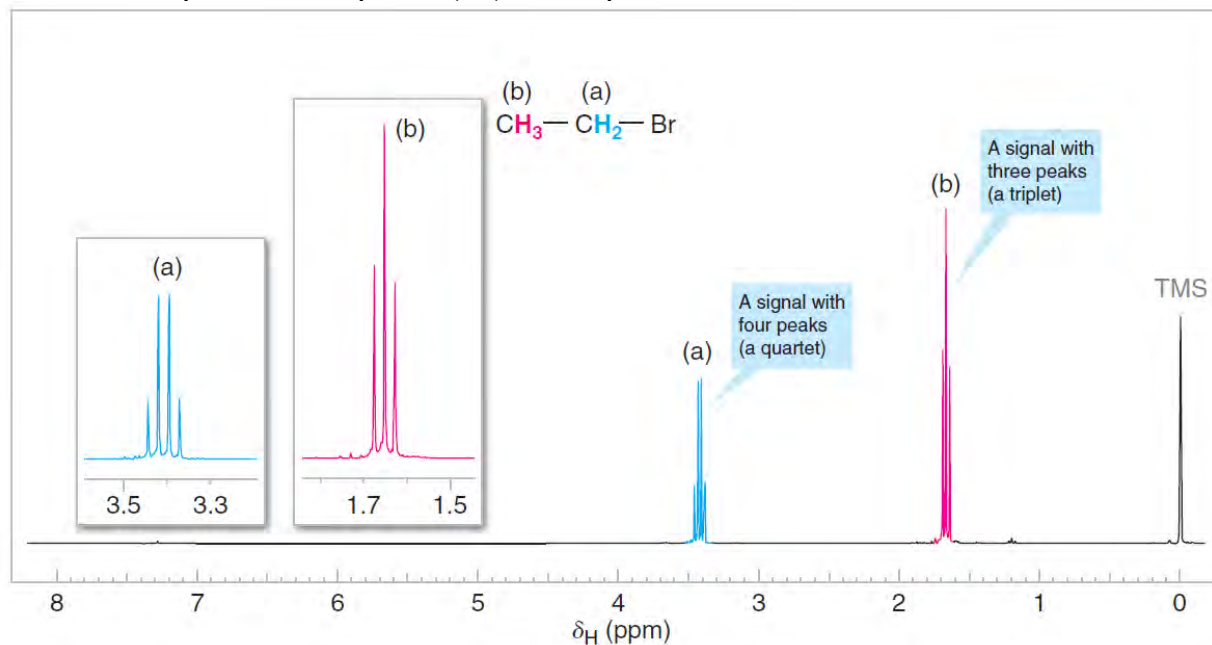

Figure 1: The 300-MHz ^1H NMR spectrum of bromoethane (ethyl bromide).

Figure 1 Explanation:

- 1. The number of signals in the spectrum** tells us **how many different sets of protons there are in the molecule**. There are *two signals arising from two different sets of protons*. One signal (consisting of four peaks) is shown in blue and labeled (a). The other signal (consisting of three peaks) is in red and is labeled (b). These signals are shown twice in the figure, at a smaller scale on the baseline spectrum, and expanded and moved to the left above the base spectrum. the signal at the far right of the spectrum (labeled TMS); it comes from a compound (tetramethylsilane) that was added to the bromoethane to calibrate the positions of the other signals.
- 2. The position of the signals in the spectrum along the x-axis** tells us about the magnetic environment of each set of protons arising largely from the electron density in their environment.
- 3. The area under the signal** tells us about **how many protons there are in the set being measured**.
- 4. The multiplicity (or splitting pattern) of each signal** tells us about **the number of protons on atoms adjacent to the one whose signal is being measured**. In bromoethane, signal (a) is split into a **quartet** of peaks by the three protons of set (b), and signal (b) is split into a *triplet* of peaks by the two protons of set (a).

II. BASIC PRINCIPLES:

1. Nuclear Spin: The Origin of the Signal

The nuclei of certain isotopes possess the quality of spin, and therefore these nuclei have spin quantum numbers, designated I . The nucleus of ordinary hydrogen, ^1H , has a spin quantum number of $1/2$, and it can assume either of two spin states: $+1/2$ or $-1/2$. These correspond to the magnetic moments (m) allowed for $I = 1/2$, which are $m = +1/2$ or $m = -1/2$. Other nuclei with spin quantum numbers $I = 1/2$ are ^{13}C , ^{19}F , and ^{31}P . Some nuclei, such as ^{12}C , ^{16}O , and ^{32}S , have no spin ($I = 0$), and these nuclei do not give an NMR spectrum. Other nuclei have spin quantum numbers greater than $1/2$. In our treatment here, however, we are concerned primarily with the spectra that arise from ^1H and from ^{13}C , both of which have $I = 1/2$. Since the proton is electrically charged, the spinning charge generates a tiny magnetic moment—one that coincides

with the axis of spin. This tiny magnetic moment gives the spinning proton properties analogous to those of a tiny bar magnet.

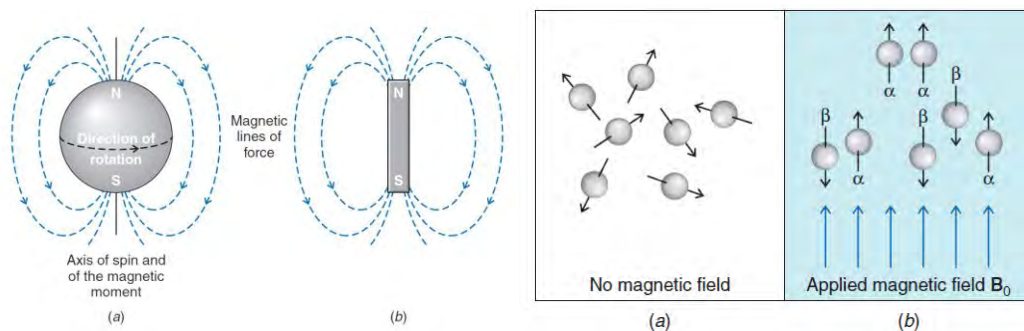

Figure 2. I(a) The magnetic field associated with a spinning proton. I(b) The spinning proton resembles a tiny bar magnet. II(a) In the absence of a magnetic field the magnetic moments of protons (represented by arrows) are randomly oriented. II(b) When an external magnetic field (B_0) is applied, the protons orient themselves. Some are aligned with the applied field (a spin state) and some against it (b spin state). The difference in the number of protons aligned with and against the applied field is very small, but is observable with an NMR spectrometer.

In the absence of a magnetic field (Fig. 2), the magnetic moments of the protons of a given sample are randomly oriented. When a compound containing hydrogen (and thus protons) is placed in an applied external magnetic field, however, the magnetic moment of the protons may assume one of two possible orientations with respect to the external magnetic field (other orientations are disallowed on the basis of quantum mechanics). The magnetic moment of the proton may be aligned “with” the external field or “against” it (Fig. 2). These alignments correspond to the two spin states mentioned earlier.

The two alignments of the proton’s magnetic moment in an external field are not of equal energy. When the proton’s magnetic moment is aligned with the magnetic field, its energy is lower than when it is aligned against the magnetic field. The lower energy state is slightly more populated in the ground state.

Energy is required to “flip” the proton’s magnetic moment from its lower energy state (with the field) to its higher energy state (against the field). In an NMR spectrometer this energy is supplied by electromagnetic radiation in the RF (radio frequency) region. When this energy absorption occurs, the nuclei are said to be *in resonance* with the electromagnetic radiation.

The energy required to excite the proton is proportional to the strength of the magnetic field (Fig. 3). One can show by relatively simple calculations that, in a magnetic field of approximately

7.04 tesla, for example, electromagnetic radiation of 300×10^6 cycles per second (300 MHz) supplies the correct amount of energy for protons.

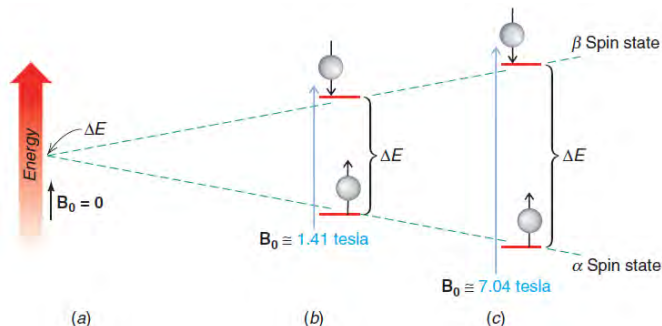
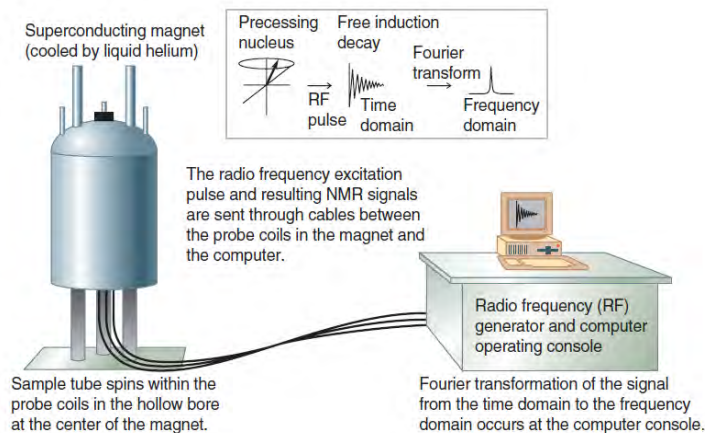

Figure 3. The energy difference between the two spin states of a proton depends on the strength of the applied external magnetic field, \mathbf{B}_0 . (a) If there is no applied field ($\mathbf{B}_0 = 0$), there is no energy difference between the two states. (b) If \mathbf{B}_0 1.41 tesla, the energy difference corresponds to that of electromagnetic radiation of 60×10^6 Hz (60 MHz). (c) In a magnetic field of approximately 7.04 tesla, the energy difference corresponds to electromagnetic radiation of 300×10^6 Hz (300 MHz).

The relationship between the frequency of the radiation (ν) and the strength of the magnetic field (\mathbf{B}_0) is $\nu = \gamma \mathbf{B}_0 / 2\pi$; where γ is the magnetogyric (or gyromagnetic) ratio. For a proton, $\gamma = 26.753 \text{ rad s}^{-1} \text{ tesla}^{-1}$.

III. NMR Spectrometers:

Most NMR spectrometers use superconducting magnets that have very high magnetic field strengths. Superconducting magnets operate in a bath of liquid helium at $-270 \text{ }^\circ\text{C}$ and they have magnetic field strengths more than 100,000 times as strong as Earth's magnetic field.



400 MHz Superconducting Magnet of an NMR Laboratory at Department of Chemistry, BIT Mesra, Ranchi

Figure 4 Principle & Diagram of a Fourier transform NMR spectrometer

As we mentioned, the chemical shift of an NMR signal is directly related to its precessional frequency. Since most compounds have nuclei in a variety of environments, they have nuclei that precess at a variety of frequencies, and therefore exhibit signals at a variety of chemical shifts. The FID signal detected by the NMR spectrometer is an aggregate of all of these frequencies. A powerful aspect of the Fourier transform (FT), as a mathematical process, is that it extracts these combined frequencies from the FID and converts them to discrete signals that we can interpret in an NMR spectrum.

IV. The Chemical Shift, PPM and the δ -Scale

All protons do not absorb at the same chemical shift (δ) in an external magnetic field. The chemical shift of a given proton is dependent on its chemical environment. The δ value that we report for a proton's chemical shift is actually a measure of its NMR absorption frequency, which is proportional to the external magnetic field strength. Smaller chemical shift (δ) values correspond with lower absorption frequency. Larger chemical shift (δ) values correspond with higher absorption frequency. Chemical shifts are most often reported in reference to the absorption of the protons of TMS (tetramethylsilane), which is defined as zero on the δ scale. A small amount of TMS is either included as an internal standard in the solvent for a sample, or the NMR spectrometer itself is calibrated electronically to a chemical shift standard TMS [$\text{Si}(\text{CH}_3)_4$]

Tetramethylsilane (TMS)

The signal from TMS defines zero ppm on the chemical shift (δ) scale.

Tetramethylsilane was chosen as a reference compound for several reasons. It has 12 equivalent hydrogen atoms, and, therefore, a very small amount of TMS gives a relatively large signal. Because the hydrogen atoms are all equivalent, they give a *single signal*. Since silicon is less electronegative than carbon, the protons of TMS are in regions of high electron density. They are, as a result, highly shielded, and the signal from TMS occurs in a region of the spectrum where few other hydrogen atoms absorb. Thus, their signal seldom interferes with the signals from other hydrogen atoms. Tetramethylsilane, like an alkane, is relatively inert. It is also volatile, having a boiling point of 27 °C. After the spectrum has been determined, the TMS can be removed from the sample easily by evaporation.

The chemical shift of a proton, when expressed in **hertz (Hz)**, is proportional to the strength of the external magnetic field. Since spectrometers with different magnetic field strengths are commonly used, it is desirable to express chemical shifts in a form that is independent of the strength of the external field. This can be done easily by dividing the chemical shift by the frequency of the spectrometer, with both numerator and denominator of the fraction expressed in frequency units (hertz). Since chemical shifts are always very small (typically <5000 Hz) compared with the total field strength (commonly the equivalent of 60, 300, or 600 *million* hertz), it is convenient to express these fractions in units of *parts per million* (ppm). This is the origin of the delta scale for the expression of chemical shifts relative to TMS:

$$\delta = \frac{(\text{observed shift from TMS in hertz}) \times 10^6}{(\text{operating frequency of the instrument in hertz})}$$

For example, the chemical shift for benzene protons is 2181 Hz when the instrument is operating at 300 MHz. Therefore,

$$\delta = \frac{2181 \text{ Hz} \times 10^6}{300 \times 10^6 \text{ Hz}} = 7.27$$

The chemical shift of benzene protons in a 60-MHz instrument is 436 Hz:

$$\delta = \frac{436 \text{ Hz} \times 10^6}{60 \times 10^6 \text{ Hz}} = 7.27$$

Thus, the chemical shift expressed in ppm is the same whether measured with an instrument operating at 300 or 60 MHz (or any other field strength).

V Examples of Structure Elucidation through ^1H NMR Spectrum

Example 1:

The 300-MHz ^1H NMR spectrum of a compound with the formula $\text{CH}_3\text{CH}_2\text{CH}_2\text{Br}$. Expansions of the signals are shown in the offset plots.

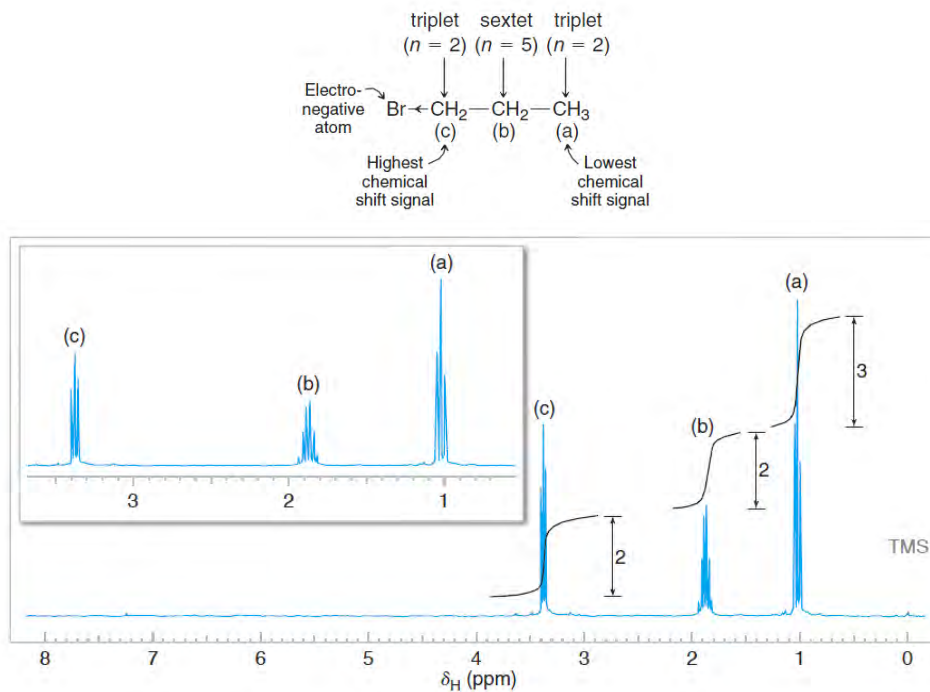

Example 2: Ethanol

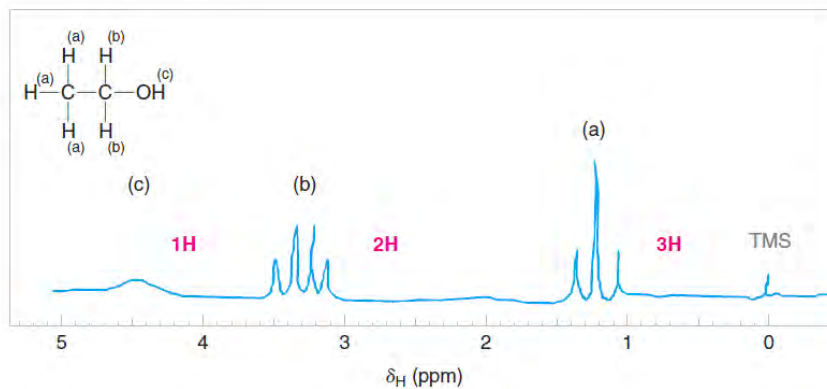

Example 3: 1,4-dimethylbenzene

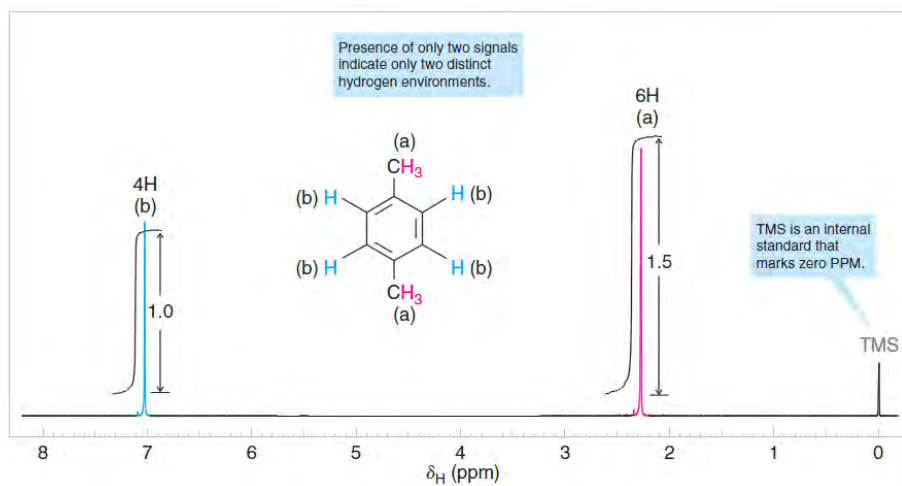

Reference Book: i) Organic Chemistry: Solomons, Fryhle, Snyder, 11e
 ii) Spectroscopy of Organic Compounds by P. S. Kalsi; 6th edition

Module V: Phase and Chemical equilibrium

[8 Lectures]

Phase rule: terms involved, Phase diagram of one component (Water) & two component (Pb/Ag) system & their applications; Gibbs Free energy, Van't Hoff equation and Chemical Equilibrium; Nernst Equation, Standard electrode potential, EMF measurement and its application, Batteries and Fuel Cells.

Phase Rule

The phase rule is a generalization given by Williard Gibbs (1876) which seeks to explain the equilibria existing in heterogeneous systems. It is well known that, in homogeneous systems the reactants and the products are in same or one phase, while in heterogeneous systems the reactants and the products are in different or two phase. With the application of phase rule it is possible to predict qualitatively by means of a diagram the effect of changing pressure, temperature and concentration on a heterogeneous system in equilibrium. Before starting the rule the involved terms like phase, component and degree of freedom need to be explained.

Terms involved

Phase is defined as any homogenous and uniform in composition, physical distinct portions of matter, which is mechanically separated from other such parts of the system by definite boundary surfaces.

Following are the examples;

- Water consists of three phases

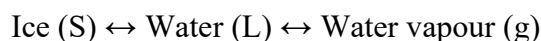

- A pure substance (solid, liquid or gas) made of one chemical species , is considered as one phase. Thus oxygen(O₂), benzene(C₆H₆) and ice (H₂O) are all one-phase system.

- A gaseous mixture, miscible in all proportions, will constitute only one phase, e.g., mixture of hydrogen and oxygen or air etc.

- The two immiscible liquids (benzene and water) will form two liquid phases.

- The two miscible liquids (i.e. alcohol and water) will form one separate phase.

- A solution of a substance in a solvent consists of one phase only e.g.: Sugar solution in water.

- A heterogeneous mixture like



Consists of three phases (i.e. two solids and one gaseous).

- Mixture of solids: Sulphur is a mixture of rhombic and monoclinic sulphur. These allotropes of sulphur consists of same chemical species but differ in physical properties. Thus a mixture of two allotropes is a two-phase system.

Component is defined as the smallest number of independent variable constituents, in terms of which the composition of each phase can be expressed in the form of chemical equation. The concept of component can be explained with the help of following examples;

- In the water system, the chemical composition of all the three phases is H₂O. Hence, it is one component system.

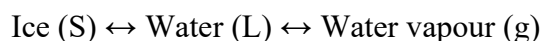

- A solution of a salt in a solvent consists of two component system, e.g, NaCl in water.

- A saturated solution of NaCl consists of solid NaCl, NaCl solution, and water vapour. The chemical composition of all the three phases is NaCl & H₂O. Hence, it is a two component system.

- Consider the thermal decomposition of MgCO₃ in closed vessel

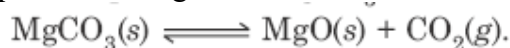

There are three phase and two component system (two solid and one gases) but two components, since any two of the three substances are sufficient to express the composition of each of three phases. For example if we choose CO₂ and MgO as two component, then;

The composition of MgO phase can be expressed as nMgO

The composition of CO₂ phase can be expressed as nCO₂

The composition of MgCO₃ can be expressed as xMgO+xCO₂

Similarly, if we choose MgO and MgCO₃ as two component, then;

The composition of MgO phase can be expressed as nMgO

The composition of CO₂ phase can be expressed as nMgCO₃+nCO₂

The composition of MgCO₃ can be expressed as xMgCO₃

□ Suppose a solid dissociate into number of gaseous substances in a closed vessel, e.g.,

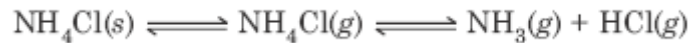

The overall composition of the dissociate vapor (NH₃, HCl) is exactly the same with the undissociate substances (NH₄Cl). Thus the number of component is one with three phases. However, if NH₃ or HCl is introduced into the system then it should be a two component system, i.e., NH₄Cl and the excess NH₃ or HCl.



$$[\text{NH}_3] = [\text{HCl}]$$

$$K_{eq} = [\text{NH}_3][\text{HCl}] / [\text{NH}_4\text{Cl}] = [\text{NH}_3][\text{HCl}]$$

[Because the active mass of NH₄Cl (s) is constant]

Now, the number of components = No. of constituents – no. of equation relating to concentration of constituents = 3(NH₄Cl, NH₃, HCl) – 2

= 1 i.e, it is a single component system.

When NH₄Cl is heated in a closed vessel along with NH₃ or HCl then :

$$[\text{NH}_3] \neq [\text{HCl}]$$

$$K_{eq} = [\text{NH}_3][\text{HCl}]$$

Therefore, only one equation relates the concentration of constituents

Hence, no. of components (C) = 3 – 1 = 2

Therefore it is a two component system.

□ The sulphur system consists of four phases, rhombic, monoclinic, liquid and vapour, the chemical composition of all the phases is 'S'. Hence, it is also one component system.

Degree of freedom is defined as the minimum number of independently variable factors, such as pressure temperature and composition (concentration or volume), which can completely define the equilibrium of a system. The least number of variable factors (concentration, pressure & temperature) which must be specified so that the remaining variables are fixed automatically and the system is completely defined.

❖ A system with F=0, is known as nonvariant or having no degree of freedom.

❖ A system with F=1, is known as univariant (having one degree of freedom)

❖ A system with F=2, is known as bivariant (having 2 degrees of freedom).

For examples;

□ A system consisting of pure gas or gas mixture, is a one phase system. If the temperature and pressure are specified, then volume can be known. So, the degree of freedom for the system is two. For a gaseous mixture of N₂ and H₂, we must state both the temperature and pressure. Hence, the system is bivariant (degree of freedom is two).

□ In the water system

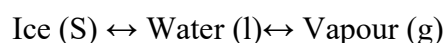

Three phases will be in equilibrium only at particular temperature and pressure. If any of the variable, i.e., temp & pressure is altered, three phases will not remain in equilibrium and one of the phases

disappears. Therefore the system is nonvariant ($F=0$) The system is, zero variant, or non-variant or invariant and has no degree of freedom.

□ For a system consisting of water in contact with its vapour.

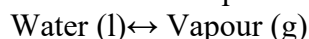

We must state either temperature or pressure to define the system completely. Hence; the degree of freedom is one (or) the system is univariant.

□ For a system consisting of



We must state either temperature or pressure. Hence the system is univariant (degree of freedom is one).

□ For pure gas: From gas law, $PV = RT$, if the values of Pressure (P) and Temperature (T) be specified, Volume (V), the third variable is fixed automatically. Hence degree of freedom (F) = 2

Phase rule

Phase rule can be stated as, in heterogeneous systems, if equilibrium between phases are not influenced by gravity, magnetic & electrical forces, but are influenced only by pressure, temperature and concentration, then the number of degree of freedom (F) of the system is related to number of components (C) and number of phases (P) by the following phase rule equation

$$F = C - P + 2$$

Merits of phase rule

1. It is applicable to both physical and chemical equilibria.
2. It is a convenient method of classifying the equilibrium states in terms of phases, components and degree of freedom.
3. It indicates different system with same degree of freedom behave similarly.
4. It helps us to predict the behaviours of a system, under different sets of variables.
5. It helps in deciding whether the number of substances remains in equilibrium or not.

Limitations of phase rule

1. Phase rule is applicable only for those systems which are in equilibrium. It is not of much use for those systems which attains the equilibrium state very slow.
2. Only three variables like P, T, & C are considered, but not electrical, magnetic and gravitational forces.
3. It is applied only to a single equilibrium system.
4. It requires utmost care in deciding the number of phases existing in equilibrium.
5. Solid and liquid phases must not be in finely – divided state; otherwise deviations occur.

Derivation of phase Rule

Consider a heterogeneous system in equilibrium, having C components in which P phases are present. According to the definition of the degree of freedom, F - is the minimum number of independent variables which must be fixed arbitrarily to define the system completely.

No. of independent variables = Total no. of variables – no. of relations between them at equilibrium

Now let us calculate total no. of independent variables:

- (1) **Temperature:** At equilibrium, temperature of every phase is same, so there is only one temperature variable of the entire system.
- (2) **Pressure:** At equilibrium, each phase has the same pressure, so there is only one pressure variable of the entire system.
- (3) **Concentration:** Concentration of each components is generally expressed in terms of mole fractions

For example, if there are two components A & B in one phase and if we know the concentration of one (say A), the concentration of other (i.e.,B) can be automatically found because sum is unity. Similarly, if we have three components and if the composition of two is known, then the composition of third can be easily found out. Thus, if we have C components, we must know the concentrations of C – 1 components. So for P phases the total composition variables are P(C – 1).

Hence, total number of variables
 $= 1$ (for temperature) + 1 (for pressure) + $P(C - 1)$ (for composition)
 $= P(C - 1) + 2$

When P phases are present, (P – 1) equations are available for each component & for C component, the total no. of equations are C(P – 1).

[If there is one component in two phases, it is possible to write one equation amongst the variables and if there is one component in three phases, it may be represented with the help of two equations.

Therefore in general when P phases are present, (P – 1) equations are available for each component and for C components, the total no. of equations are C(P – 1).]

F = total no. of variables – no. of equations between them at equilibrium

$$F = [P(C-1) + 2] - [C(P-1)]$$

Hence, F (Degree of freedom) = C – P + 2

Phase diagram

Phase diagram is a graph obtained by plotting one degree of freedom against another. If temperature is plotted against pressure, the diagram is called P-T diagram. Similarly, a plot of temperature against composition is known as T-C diagram. By the phase diagram, we may understand the behaviour of the system, stability and equilibrium between phases. Systems are classified, on the basis of number of components, into three types.

1. One component systems
2. Two component systems
3. Three component systems

Phase diagram of one component system

In any system, the minimum number of phases is one. It is evident from the phase rule equation

$$F = C - P + 2 = 1 - 1 + 2 = 2$$

For one component system the maximum number of degree of freedom is two. The maximum number of phases in any system is three, from the phase rule equation

$$F = C - P + 2 = 1 - 3 + 2 = 0$$

The minimum number of degree of freedom is zero for one component system. From the above calculations, it is clear that for any one-component system the maximum number of degree of freedom is two. Therefore, such a system can be presented completely by a two dimensional diagram. Hence, we may draw the phase diagram by taking pressure and temperature as the two axes. These are known as pressure-temperature (P-T) diagrams, concentration (or) composition remains constant.

The Water system:

Water can exist in three possible phases, namely, solid, liquid and vapour. Hence, there can be three equilibria with two phases for each equilibrium:

1. Liquid ↔ vapour
2. Solid ↔ Vapour
3. Solid ↔ Liquid

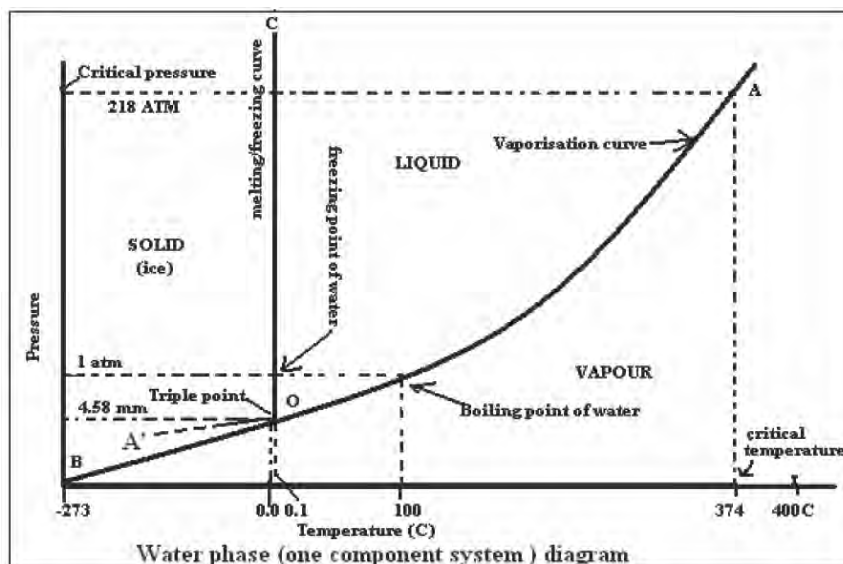

The curve OA is called the vapourization curve of water; it represents the equilibrium between liquid water and vapour. At any point on the curve the following equilibrium will exist.



The degree of freedom of the system is one, i.e., univariant. This is predicted by the phase rule.

$$F=C-P+2; F=1-2+2; F=1$$

This equilibrium will extend up to the critical temperature (374°C). Beyond the critical temperature, the equilibrium will disappear only water vapour will exist.

The curve OB is called the sublimation curve of ice; it represents the equilibrium between ice and vapour. At any point on the curve the following equilibrium will exist.



The degree of freedom of the system is one i.e., univariant. This is predicted by the phase rule.

$$F=C-P+2; F=1-2+2; F=1$$

This equilibrium will extend up to the absolute zero.

Triple point: The vaporization curve (OA) and the sublimation curve (OB) meet at point O, where three phases, namely solid, liquid and vapour will coexist. Such a point is known as the “triple point”. Temperature and pressure at the triple point of water are 0.0098 °C and 4.58 mm respectively, according to phase rule, the degree of freedom is zero i.e., invariant.

$$F=C-P+2; F=1-3+2; F=0$$

The curve OC is called the fusion curve of ice; it represents the equilibrium between ice and water. At any point, on the curve the following equilibrium will exist.

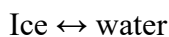

The curve OC shows how is the melting point of ice increased by increasing pressure. The degree of freedom of the system is one, i.e., univariant.

The curve OA' is called vapour pressure curve of the super-cool water (or) metastable equilibrium. Some times water can be cooled below 0°C without the formation of ice; this water is known as super-cool water. The super-cool water can be preserved if the system is not subjected to stirring (or) “Seeding” by solid. At any point on the curve the following equilibrium will exist.

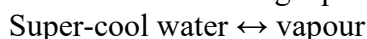

The degree of freedom of the system is one i.e., univariant.

Area AOB, AOC and BOC contain vapour, liquid and ice phases respectively, with in these single-phase areas, the system is bivariant. This is predicted by the phase rule.

$$F=C-P+2; F=1-1+2; F=2$$

To locate any point in an area, temperature and pressure needs to be known.

Phase diagram of Two-component systems

For binary mixtures of two chemically independent components,

$$C = 2 \text{ so that } F = 4 - P$$

In addition to temperature and pressure, other variables are the composition of each phase, often expressed as mole fraction or mass fraction of one component. As an example, consider the system of two completely miscible liquids such as toluene and benzene, in equilibrium with their vapours. This system may be described by a boiling-point diagram which shows the composition (mole fraction) of the two phases in equilibrium as functions of temperature (at a fixed pressure). Four thermodynamic variables which may describe the system include temperature (T), pressure (p), mole fraction of component 1 (toluene) in the liquid phase (x_{1L}), and mole fraction of component 1 in the vapour phase (x_{1V}). However since two phases are in equilibrium, only two of these variables can be independent ($F = 2$). This is because the four variables are constrained by two relations: the equality of the chemical potentials of liquid toluene and toluene vapour, and the corresponding equality for benzene. For given T and p, there will be two phases at equilibrium when the overall composition of the system (system point) lies in between the two curves. A horizontal line (isotherm or tie line) can be drawn through any such system point, and intersects the curve for each phase at its equilibrium composition. The quantity of each phase is given by the lever rule (expressed in the variable corresponding to the x-axis, here mole fraction). For the analysis of fractional distillation, the two independent variables are instead considered to be liquid-phase composition (x_{1L}) and pressure. In that case the phase rule implies that the equilibrium temperature (boiling point) and vapour-phase composition are determined. Liquid-vapour phase diagrams for other systems may have azeotropes (maxima or minima) in the composition curves, but the application of the phase rule is unchanged. The only difference is that the compositions of the two phases are equal exactly at the azeotropic composition.

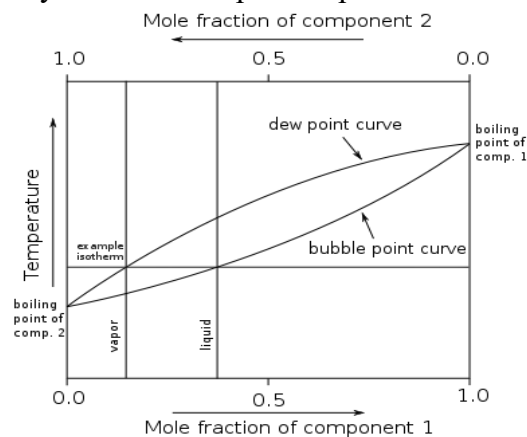

Phase diagram of two component: reduced phase rule (or) condensed phase rule

In a two – component system, minimum number of phases is one, i.e., $P = 1$, according to the phase rule equation, the maximum degree of freedom is three

$$F = C - P + 2; F = 2 - 1; F = 3$$

So, the phase diagram of a binary system should be represented by a three dimensional diagram of temperatures, pressure and composition, which can not be drawn on paper. Generally solid-liquid equilibrium of an alloy has “no gas phase” and the effect of pressure is small. Therefore, experiments are conducted under atmospheric pressure. Thus, the system in which the pressure is constant (vapour phase is not considered) is known as condensed system. The phase rule becomes.

$$F' = C - P + 1$$

This is known as **reduced phase rule (or) condensed phase rule**. The phase diagram can be drawn by taking temperature and composition as the two axis. This is known as (T-C) diagram. The reduced phase rule is used only when atmospheric pressure is larger than actual vapour pressure of the component. Depending upon the solubility of the two components and their reactive ability, two component systems are classified into three types

1. Simple Eutectic formation: If two substances are completely miscible in the liquid state, but completely immiscible in the solid state, form a simple eutectic. Of the various mixture, one mixture has the lowest melting point such a mixture is known as a eutectic mixture (eutectic means easy melting).

2. Solid solution formation: When two substances, especially metals, are completely miscible in both the solid and liquid states, they form solid solutions, where mixing takes place in the atomic levels. A condition for the formation of solid solution is, the two metals should not differ in atomic radius by more than 15%.

3. Compound formation: Under some conditions, two metals chemically react to give one or more compounds with definite proportions. Of the compounds, a compound is said to possess congruent (constant) melting point, if it melts exactly at a constant temperature into liquid, having the same composition as that of solid.

Pb-Ag system:

It is a two-component Simple Eutectic system. Here four possible phases are solid Ag, Solid Pb, solution of Ag-Pb and vapor. However, at the constant atmospheric pressure, the vapor phase is absent and reduced phase rule is applicable as $F=C-P+1$. The phase diagram of the Pb-Ag system is shown in the figure below;

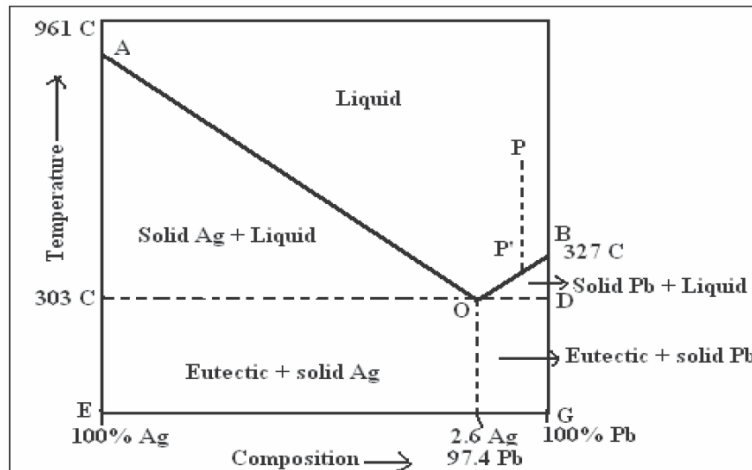

Curve AO: Point A is the melting point of pure Silver. Curve AO shows melting point depression of silver by the addition of lead. At any point in this curve there is equilibrium between solid Ag and liquids part. According to reduced phase rule equation. The system is univariant.

$$F'=C-P+1; F'=2-2+1; F'=1$$

Curve BO: Point B is the melting point of pure lead, (327°C), curve BO shows the melting point depression of lead on gradual addition of silver to it. Along this curve solid lead and solution co – exist and hence the system is univariant.

Point O: The two curves AO & BO meet at point O, where three phases solid pb, solid Ag and their solution co-exist, according to condensed phase rule the system is invariant.

$$F'=C-P+1; F'=2-1+1; F'=2$$

The point 'O' is known as eutectic point, its composition (Ag=2.6%; Pb=97.4%) and temperature (303OC) is known as eutectic composition and eutectic temperature respectively. Further cooling below the eutectic temperature respectively. Further cooling below the eutectic temperature will cause simultaneous crystallization of a mixture of lead and silver.

Area AOB: Consists of only one phases namely pb-Ag solution. According to reduced phase rule equation.

$$F'=C-P+1; F'=2-1+1; F'=2$$

The system is bivariant i.e., both T & composition has to be specified to define the system.

Let us consider a point p, which represents a sample of lead containing less than 2.6% silver. On cooling the temperature falls gradually till point p'. On further cooling lead begins to separate and the concentration of Ag increase in the solution till the point O is reached, after that whole mass solidifies (2.6% Ag; 97.4% pb). This process is utilized in the pattinson's process of desilverization of lead. Below the eutectic point (O), area COEF consists of solid and eutectic compound, where crystalline silver and eutectic compounds are stable. Similarly the area ODFG consists of solid Pb and eutectic compound, where crystalline lead eutectic compounds are stable.

Applications

Pattinson's process: If a sample of argent ferrous lead, containing less than 2.6% Ag is allowed to cool gradually, lead will separate out and the solution will become progressively richer in Ag, till the percentage 2.6 of Ag is reached; and on further cooling, the whole mass will solidify as such. On the other hand, if lead-silver alloy containing Ag greater than 2.6% is allowed to cool, and then pure silver separates along the curve AO, till the eutectic composition at O is reached.

Thermal analysis or cooling curve: The shape of the cooling curve can be determined by thermal analysis. Thermal analysis is a method involving a study of cooling curves of the various compositions of a system during solidification. The cooling curve is obtained by plotting fall of temperature with time. The principle of the method can be understood from the following examples. In that addition, a compound is said to possess **incongruent melting point**, if it decomposes completely at a temperature below its melting point yielding a new solid phase with a composition different from that of the original.

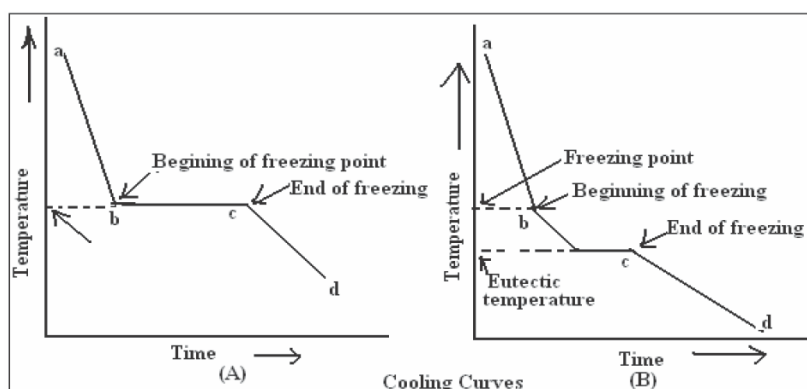

1. When a pure substance in the liquid state is allowed to cool slowly and the temperature is noted at definite times. The cooling curve (fig) shows the rate of cooling is continuous up to the point 'b' the solid begins to separate, and the temperature will remain constant, until the liquid is completely solidified (indicated by the line 'b'). Thereafter, the fall in temperature will again become continuous (indicated by the line 'cd').

2. If a mixture of two solids in the liquid state is cooled slowly and the cooling curve is obtained in a similar manner (fig). The cooling curve shows the rate of cooling is continuous up to the point 'b'. At the point 'b' one of the solids begins to separate, this separation will extent up to the point 'c'. At the point 'c' the eutectic compound begins to separate. The temperature remains constant along cd until the solidification completes. Thereafter the fall of temperature becomes uniform, but the rate of fall is quite different from the previous one.

Uses

1. Melting point and eutectic temperature can be noted from the cooling curve.
2. Percentage purity of the compounds can be known.
3. The behaviour of the compounds can be clearly understood from the cooling curves.
4. The procedure of thermal analysis can also be used to derive the phase diagram of any two component system.

Heat treatment of steel: Heat treatment involves the combination of heating and cooling of a metal or alloy in one or more temperature cycles to confer desirable physical properties to the metal or alloy. Heat treatment of steel may be carried out under near equilibrium conditions to improve the ductility or under non equilibrium conditions to enhance the hardness. During heat treatment the size and shape of the grains or the composition of the phase undergoes changes with respect to the micro constituents and also in addition, the internal stresses will be relieved.

Hardening: Hardening involves the transformation of austenite to martensite or the bainite phase, making the steel hard. If steel is quenched by plunging into water or oil to 204 °C or lower temperature the carbon atoms do not have sufficient time to form cementite but remain trapped in the lattice. The excess carbon precipitates out in hot metal and prevents the slipping of the planes. Thus quenched steel is quite hard and strong but has lower ductility. This heat treatment is called transformation hardening. Further the quenched steel is not useful for construction purposes, because of its brittleness. Therefore quenching is always followed by another heat treatment process called tempering. The quenched steel is tempered by reheating to below α -iron or γ -iron transition temperature. Normally on tempering, the steel becomes tougher and ductile. Tempering is carried out at about 200 °C to make hard steel resistant to abrasion or at higher temperature (~ 540 °C) to make tough steel capable of withstanding shock loads.

Case hardening: is a surface treatment by which the inside soft core of steel is hardened on the surface. Low carbon steels are case hardened because they cannot be hardened by quenching.

Cyaniding: also produces case hardened, medium carbon steel articles. Here the article is immersed in a molten bath of sodium or potassium cyanide at about 850 °C for some times to facilitate the adsorption of both carbon and nitrogen and then quenched in oil or water.

Nitriding: produces a hard surface on alloy steels. The process involves heating the alloy in the presence of ammonia to about 550 °C. Ammonia decomposes and nitrogen formed combines with alloying elements to form hard nitrides on the surface of the alloy.

Annealing: Annealing involves heating and holding the steel at a suitable temperature for some times to facilitate the dissolution of carbon in γ -iron followed by a slow cooling in a controlled manner in a furnace. Steel is softened and becomes ductile and machineable. However annealing decreases the hardness and strength of steel. Annealed hypereutectoid steels contain cementite. They are not soft but can be machined easily. In contrast annealed hypo eutectoid steels contain ferrite and are relatively soft and malleable.

Chemical equilibrium

When reactants are mixed in exact stoichiometric proportion to perform a chemical reaction, it is believed that all the reactants would be converted into products with the release or absorption of energy. This is not true in all cases. Chemical reactions can be classified as: Irreversible and Reversible reactions.

Most of the reactions occur only in one direction. They are called irreversible reactions. For example;

Carbon is burnt in air:
$$\text{C (s)} + \text{O}_2 \text{ (g)} \longrightarrow \text{CO}_2 \text{ (g)}$$

Neutralisation reaction:
$$\text{HCl (aq)} + \text{NaOH (aq)} \longrightarrow \text{NaCl (aq)} + \text{H}_2\text{O (l)}$$

Precipitation reaction:
$$\text{NaCl (aq)} + \text{AgNO}_3 \text{ (aq)} \longrightarrow \text{AgCl (s)} + \text{NaNO}_3 \text{ (aq)}$$

Strictly speaking all reactions are considered to be reversible. But the rate of reaction in one particular direction is extremely small compared to the other. Thus the reaction proceeds practically in one direction to near completion, leaving a negligibly small amount of reactant at the end.

A reaction is said to be reversible if under certain conditions of temperature and pressure, the forward and reverse reactions occur simultaneously.

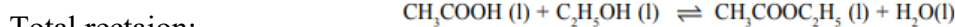
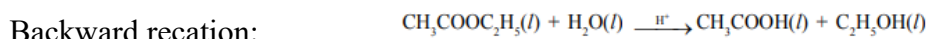
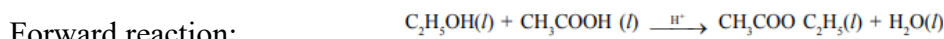

Many chemical reactions proceed only to a certain extent and stop. When analysed, the resulting mixture contains both the reactants and products. It is because when reactants combine to form products, the products also start combining to give back the reactants. When such opposing processes take place at equal rates, no reaction appears to take place and it is said that a state of equilibrium has reached.

A reversible reaction is said to be in the equilibrium state when the forward and backward reaction occur simultaneously at the same rate in a closed system and the concentrations of reactants and products do not change with time. In a chemical reaction, chemical equilibrium is the state in which both reactants and products are present in concentrations which have no further tendency to change with time. The chemical equilibrium is achieved when the rate of forward reaction is same as the reverse reaction. Since the rates are equal, there are no net changes in the concentrations of the reactant(s) and product(s). This state is known as dynamic equilibrium. The entire process can be graphically represented by this diagram.

A common example of reversible reactions of the type $A + B \rightleftharpoons C + D$

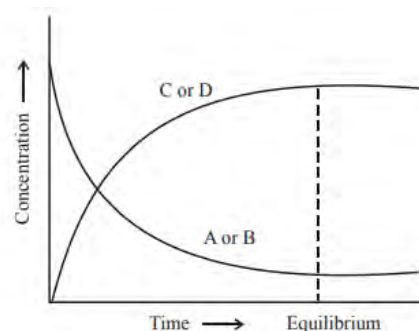
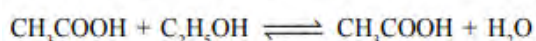

Characteristics of equilibrium state. The state of equilibrium has following characteristics properties:

(i) Chemical Equilibrium is dynamic in nature. The chemical equilibrium is the result of two equal but opposite processes occurring in the forward and reverse directions and there is no “net” change occurring in the system.

(ii) Equilibrium can be attained from either side. The same state of equilibrium (characterized by its equilibrium constant which is discussed later) can be reached whether the reaction is started from the reactants or products side. For example, the same equilibrium.

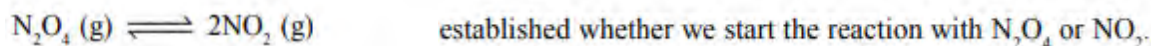

(iii) Equilibrium can be attained only in a closed system. Equilibrium can be attained only if no substance among, reactants or products, is allowed to escape i.e. the system is a closed one. Any system consisting of gaseous phase or volatile liquids must be kept in a closed container.

Gaseous phase or volatile liquids must be kept in a closed container:
$$N_2(g) + 3H_2(g) \rightleftharpoons 2NH_3(g)$$

Non-volatile liquid and solid phases even in an open container:
$$FeCl_3(aq) + 3NH_4SCN(aq) \rightleftharpoons Fe(SCN)_3(s) + 3NH_4Cl(aq)$$

(iv) A catalyst can not change the equilibrium state. Addition of a catalyst speeds up the forward and reverse reactions by same extent and help in attaining the equilibrium faster. However, the equilibrium concentrations of reactants and products are not affected in any manner.

Law of chemical equilibrium

Chemical Equilibrium can easily be understood by understanding Chemical Kinetics. It is the study of the rate of the reactions under various conditions. Another concept that forms the basis is the Law of mass action. Law of mass action states that the ‘Rate of a chemical reaction is directly proportional to

the product of the concentrations of the reactants raised to their respective stoichiometric coefficients'. At equilibrium forward and backward rates are equal and the ratio of the rate constants is a constant and is known as an equilibrium constant. In a reaction mixture at equilibrium, the concentrations of the reactants and products are related by an equilibrium constant. So, Given a reaction:

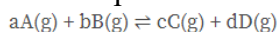

Using the Law of mass action,

$$\text{Forward reaction rate} = k_+ [A]^a [B]^b$$

$$\text{Backward reaction rate} = k_- [C]^c [D]^d$$

where, [A], [B], [C] and [D] being the active masses and k_+ and k_- are rate constants.

Forward reaction rate = Backward reaction rate

$$k_+ [A]^a [B]^b = k_- [C]^c [D]^d$$

We have,

$$K_c = k_+ / k_-$$

$$K_c = [C]^c [D]^d / [A]^a [B]^b$$

The Law of Chemical Equilibrium is defined as, the ratio of product of concentration of the products to the product of concentration of the reactants, with each concentration term is raised to the power by its coefficient in overall balanced chemical equation, is a constant quantity at a given temperature and it is called equilibrium constant.

Equilibrium constants and their significance

The concentrations values in the law of equilibrium are the equilibrium concentrations of reactants and products. K_c is called the concentration equilibrium constant. In case of gases their partial pressures can also be used in place of molar concentrations (since the two are directly proportional to each other) in the law of equilibrium. The new equilibrium constant, K_p , is called the pressure equilibrium constant. For the reaction between H_2 and I_2

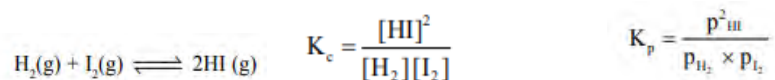

Here all are the equilibrium partial pressures of H_2 , I_2 and HI respectively. For the general gas phase reaction:

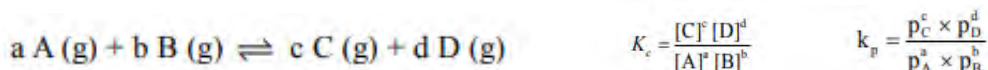

The equilibrium constant of a reaction has a constant and characteristic value at a given temperature. The changes in starting concentration, pressure and the presence of a catalyst do not change the value of the equilibrium constant. However if the temperature is changed. The value of the equilibrium constant also changes. The magnitude of the equilibrium constant is a measure of the extent upto which a reaction proceeds before the equilibrium is reached. The magnitude of K is large when the products are present in larger amounts than the reactants in the equilibrium mixture. For example;

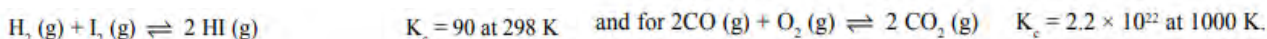

A large value of K_c for the second reaction indicates that amount of products is much more than the reactants present at the time of equilibrium. Thus the magnitude of equilibrium constant tells us about the position of the equilibrium.

If a system is subjected to a change in concentration of one or more reactants, or a change in temperature or pressure, the equilibrium condition of the system is altered. In 1884, a French Chemist and Engineer, Le Chatelier, showed that in every such case, the new equilibrium state partially reduces the effect of change that brought it about. This principle is known as Le Chatelier's Principle. The principle states that, if a system at equilibrium is subjected to a change of pressure or temperature or number of moles of the component, there will be a tendency for a net reaction in the direction that reduces the effect of this change. Generally we can say that;

An increase in the concentration of the reactants shifts the equilibrium in the forward direction and a decrease in the concentration of the reactants shifts the equilibrium in the backward direction. Similarly, an increase in concentration of the products shifts the equilibrium in the backward direction and a decrease in the concentration of the products shifts the equilibrium in the forward direction.

- If we add potassium chloride to the solution, the concentration of potas

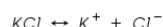

It affects the equilibrium between potassium ions and thiocyanate ions.

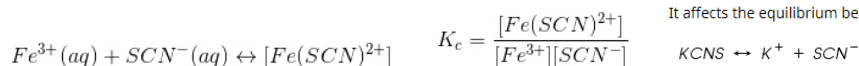

The pressure dependence of the equilibrium constant is usually weak in the range of pressures normally encountered in industry, and therefore, it is usually neglected in practice. This is true for condensed reactant/products (i.e., when reactants and products are solids or liquid) as well as gaseous ones. In gas phase reaction the Change in pressure affects equilibrium involving gaseous phase either in a homogeneous or heterogeneous system.

Case I: When the number of moles of products is more than the total number of moles. Increase in total pressure keeping the temperature constant, will cause a decrease in volume. This means that the number of moles per unit volume will increase. A net change will take place in the equilibrium in the direction where the number of moles decrease i.e. backward direction.

Case II: When the number of moles of products is less than reactants. Increase in total pressure will bring a net change to the equilibrium in the direction where the total number of moles is decreasing. Decrease in total pressure will bring the net change to equilibrium in the direction where the total number of moles is increasing i.e. backward direction.

Case III: When there is no change in the total number of moles of reactant and product as in the following state of equilibrium. There is no net change in equilibrium state when pressure is changed.

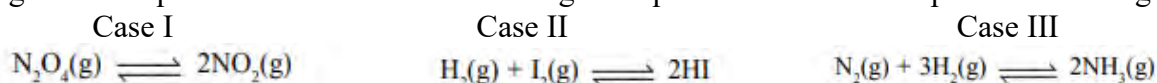

Equilibrium Constant & Gibbs Free energy:

The Equilibrium constant is related to the standard Gibbs free energy change for the reaction. The relation is given by the equation:

$$\Delta G^\ominus = -RT \ln K_{eq}$$

Where, R is the universal gas constant, T is the temperature and K_{eq} is the equilibrium constant. Using the definition of Gibbs free energy & Gibbs free energy Isotherm equation, we have:

$$\Delta G^\ominus = \Delta H^\ominus - T\Delta S^\ominus,$$

$$\Delta G^\ominus = -RT \ln K_{eq},$$

$$\ln K_{eq} = -\frac{\Delta H^\ominus}{RT} + \frac{\Delta S^\ominus}{R}.$$

Where, K_{eq} is the equilibrium constant at temperature T, ΔH^\ominus and ΔS^\ominus are constants and are enthalpy and entropy of the system respectively. This graph of this equation is called the Van't Hoff plot. The plot is used to estimate the enthalpy and entropy of a chemical reaction. From the plot between " $\ln K_{eq}$ " & " $1/T$ ", we have $-\Delta H/R$ as the slope, and $\Delta S/R$ as the intercept of the linear fit. Equilibrium constant K_c depends on the temperature of the reaction and the relation is given by Van't Hoff equation.

$$\ln \frac{K_2}{K_1} = \frac{-\Delta H^\ominus}{R} \left(\frac{1}{T_2} - \frac{1}{T_1} \right).$$

K_1 is the equilibrium constant at absolute temperature T_1 , K_2 is the equilibrium constant at absolute temperature T_2 , R is the ideal gas constant, ΔH reaction enthalpy assumed to be constant over the temperature range. This equation can be used to estimate a new equilibrium constant at a new absolute temperature assuming a constant standard enthalpy change over the temperature range. Let's understand the change in the equilibrium constant for two different kinds of reactions: Endothermic & Exothermic.

• **Exothermic reactions**

- For an exothermic reaction, heat is released, making the net enthalpy change negative.
- $\Delta H < 0$, so slope $(-\Delta H/R)$ is positive.
- Van 't Hoff plot has a positive slope.

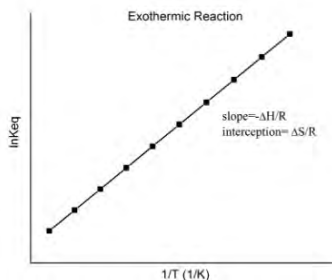

• **Endothermic reactions**

- For an endothermic reaction, heat is absorbed, making the net enthalpy change positive.
- $\Delta H > 0$, so slope $(-\Delta H/R)$ is negative.
- Van 't Hoff plot has a negative slope.

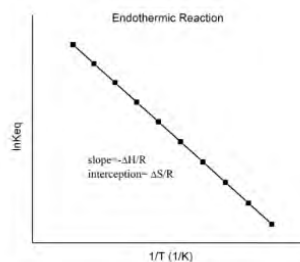

Types of Chemical Equilibria

There are two types of chemical equilibria: Homogeneous equilibria and Heterogeneous equilibria **Homogeneous Equilibria.** The equilibrium reactions in which all the reactants and the products are in the same phase are known as homogeneous equilibrium reactions. These are divided into two categories:

The number of product molecules is equal to the number of reactant molecules. For example:

- The number of product molecules is equal to the number of reactant molecules. For example:
 - $N_2(g) + O_2(g) \rightleftharpoons 2NO(g)$
 - $H_2(g) + I_2(g) \rightleftharpoons 2HI(g)$
- The number of product molecules is not equal to the number of reactant molecules.
 - $COCl_2(g) \rightleftharpoons CO(g) + Cl_2(g)$
 - $2SO_2(g) + O_2(g) \rightleftharpoons 2SO_3(g)$

- The equilibrium constant for the homogeneous reaction in gaseous systems:

• Ideal gas equation is given by, $pV = nRT$

$$\Rightarrow p = \frac{n}{V} RT$$

If concentration C is in mol L⁻¹ or mol dm⁻³ and p is in bar, then we can write $p = cRT$ or, $p = [\text{gas}] RT \dots (i)$ Where $R = 0.0831 \text{ bar L mol}^{-1} \text{ K}^{-1}$ For a general reaction,

$$\begin{aligned}
 aA + bB &\rightleftharpoons cC + dD \\
 K_p &= \frac{(p'_c)^c (p'_d)^d}{(p'_a)^a (p'_b)^b} \\
 &= \frac{([C]RT)^c ([D]RT)^d}{([A]RT)^a ([B]RT)^b} \quad \text{[From equation (i)]} \\
 &= \frac{[C]^c [D]^d (RT)^{c+d}}{[A]^a [B]^b (RT)^{a+b}} \\
 &= \frac{[C]^c [D]^d}{[A]^a [B]^b} (RT)^{(c+d)-(a+b)} \\
 &= \frac{[C]^c [D]^d}{[A]^a [B]^b} (RT)^{\Delta n} \\
 &= K_c (RT)^{\Delta n} \quad \left[\text{Since, } K_c = \frac{[C]^c [D]^d}{[A]^a [B]^b} \right]
 \end{aligned}$$

- In gaseous phase,

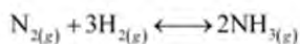

- In solution phase,

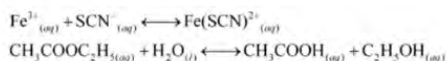

In the above equation, $\Delta n = (\text{number of moles of gaseous products}) - (\text{number of moles of gaseous reactants})$ in the balanced chemical equation and while calculating K_p , pressure should be expressed in bar (1 bar = 10⁵ Pa = 10⁵ Nm⁻²)

Heterogeneous Equilibria. The equilibrium reactions in which the reactants and the products are present in different phases are known as heterogeneous equilibrium reactions. For example;

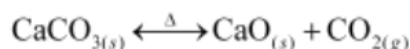

pure solids, $[CaO]$ and $[CaCO_3]$ are constants

$$K_c = \frac{[CaO_{(s)}][CO_{2(g)}]}{[CaCO_{3(s)}]}$$

$$K'_c = [CO_{2(g)}]$$

$$K_p = p_{CO_2}$$

The concentrations of pure solids like $[CaO]$ and $[CaCO_3]$ in the above case or the pure liquids to be considered as constant and do not appear in K_p expression.

Weak and strong electrolytes

A redox reaction involves the transfer of electrons from one chemical species to another. Amount (moles) of the salt that has made the solution saturated per liter of solution is called the solubility of the salt. For salt AB.

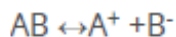

Those substances which allow the passage of electricity by way of the aqueous solution or the fused state and undergo chemical decomposition are called electrolytic conductors. Some examples are the aqueous solution of acids, bases and salts. Following are the two types of electrolytes;

- **Strong electrolytes:** Those electrolytes which completely ionise or dissociate into ions are known as strong electrolytes. Some of the examples of strong electrolytes are HCl, NaOH, K₂SO₄.
- **Weak electrolytes:** Those electrolytes that dissociate partially ($\alpha < 1$) are known as weak electrolytes. Some of the examples of weak electrolytes are CH₃COOH, H₂CO₃, NH₄OHH₂S, etc.

The energy from a redox reaction can be used to accomplish work by constructing an electrochemical cell. In an electrochemical cell, the oxidation process and the reduction process are separated into two half-cells connected by an external wire. The half-cell with the oxidation process is losing negative charge (e⁻ loss) while the half-cell with the reduction process is gaining negative charge (e⁻ gain). To maintain electrical neutrality in both half-cells, a salt bridge (or semipermeable membrane) must connect the two half-cells to permit the transfer of ions between the two solutions. Thus, the salt bridge completes the electrical circuit between the half cells.

The transfer of electrons through the external wire create a current that can do work. The driving force pushing the electrons through the wire is the difference in the attraction for electrons in the two half-cells. This voltage difference is called the cell potential (E_{cell}) and is measured in volts. The cell potential (E_{cell}) is directly related to the magnitude of the equilibrium constant for the overall oxidation-reduction reaction occurring in the cell. A reaction that more strongly favors product formation (larger K_{eq}) will have a higher cell potential (larger E_{cell}) than a reaction which only moderately favors product formation.

General Representation of Electrochemical Cells

Parameter	Cathode	Anode
Sign	Positive due to consumption of electrons	Negative due to release of electrons
Reaction	Reduction	Oxidation
Movement of electrons	Into the cell	Out of Cell

Standard electrode potential and its application to different kinds of half cells

Standard cell potentials (E^o_{cell}) can be calculated from potentials (E^o) for oxidation and reductions reactions measured under standard conditions (1.00 M solutions, 1.00 atm pressure, 298 K). A positive cell potential means the reaction proceeds spontaneously in the direction the reaction is written; a reaction with a negative cell potential proceeds spontaneously in the reverse direction.

$$E^{\circ}_{\text{cell}} = E^{\circ}_{\text{reduction}} + E^{\circ}_{\text{oxidation}}$$

A galvanic cell is constructed from solutions in two beakers connected by a salt bridge and an external wire. One beaker contains 0.15 M Cd(NO₃)₂ and a Cd metal electrode. The other beaker contains 0.20 M AgNO₃ and Ag metal electrode. In the reaction, cadmium metal is oxidized (loses electrons) and is, therefore, the anode. The silver ion is reduced (gains electrons) to form Ag⁰ (the cathode).

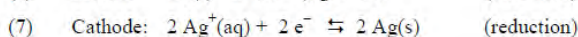
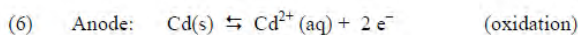

Using the rules listed below, cell notation is:

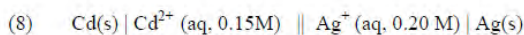
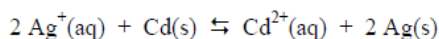

Cell Notation Rules:

1. The anode half-cell is described first; the cathode half-cell follows. Within a given half-cell, the reactants are specified first and products last. As the reader's eye proceeds from left to right s/he is reading a description of the oxidation reaction first and the reduction reaction last (in other words - the direction of electron flow). Spectator ions are not included.

2. A single vertical line indicates that species are in different phases (*e.g.* solid electrode | liquid with electrolyte), but in physical contact with each other. A double vertical line indicates a salt bridge or porous membrane separating the individual half-cells.

3. The phase of the species (s, l, g, aq) is always shown in parentheses. If the electrolytes in the cells are not at standard conditions, concentrations and/or pressure should be included with phase in parentheses as shown in equation (8). If no concentration or pressure is noted, the electrolytes in the cells are assumed at standard conditions (1.00 M or 1.00 atm and 298K).

Although many applications of electrochemical cells involve a flow of current between the two electrodes, the most fundamental kind of measurement we can make is of the voltage, or electromotive force (EMF) between the electrodes in the absence of any cell current. This voltage, which we usually refer to as the *cell potential*, is the potential difference between the electrodes, and is the difference between the *half-cell potentials* of the right and left sides. Each of the half-cell potentials is in turn a potential difference between the electrode and the solution, so for our example cell the above relation can be expanded as follows;

$$E_{\text{cell}} = \Delta V = V_{\text{right}} - V_{\text{left}}$$

$$E_{\text{cell}} = V_{\text{Cu}} - V_{\text{soln}} + V_{\text{soln}} - V_{\text{Zn}}$$

It is important to understand that individual half-cell potentials are not directly measurable; there is no way you can determine the potential difference between a piece of metal and a solution. Attaching one lead of a voltmeter to the metal and dipping the other in the solution would simply create a new half-cell involving the immersed metallic conductor.

EMF and its measurement and application

When the concentrations of solutes or partial pressures of gases are not at standard conditions, the cell potential (E_{cell}) can be determined with the Nernst equation. For the general cell reaction occurring at 298 K, the Nernst equation can be rewritten as shown as follows;

$$E_{\text{cell}} = E^{\circ}_{\text{cell}} - (0.059 / n) \log Q \quad (\text{Nernst equation}) \quad a\text{A} + b\text{B} \rightleftharpoons c\text{C} + d\text{D}$$

Q: reaction quotient

n: moles of e⁻ transferred

$$(E_{\text{cell}} = E^{\circ}_{\text{cell}} - (0.059 / n) \log ([\text{C}]^c [\text{D}]^d / [\text{A}]^a [\text{B}]^b))$$

The Standard Potential Table in your textbook lists many half-cell reactions and their voltages. These potentials are measured relative to a selected standard half-reaction (usually the Standard Hydrogen Electrode (SHE)).

The fact that individual half-cell potentials are not directly measurable does not prevent us from defining and working with them. If we cannot determine the absolute value of a half-cell potential, we can still measure its value in relation to the potentials of other half cells. In particular, if we adopt a reference halfcell whose potential is arbitrarily defined as zero, and measure the potentials of various other electrode systems against this reference cell, we are in effect measuring the half-cell potentials on a scale that is relative to the potential of the reference cell. As a reference cell we use the half cell whose reaction is;



This is the hydrogen electrode, an example of a gas electrode as was discussed above. When this electrode is set up under standardized conditions, it becomes the standard hydrogen electrode, sometimes abbreviated SHE. In order to measure the relative potential of some other electrode M^{2+}/M , we can set up a cell

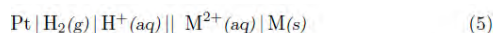

∴, the potential difference between the platinum and M

$$E_{cell} = V_M - V_{soln} + V_{soln} - V_{Pt}$$

But since the difference $V_{soln} - V_{Pt}$ is by definition zero for the hydrogen half-cell, the cell potential we measure corresponds to

$$E_{cell} = V_M - V_{soln}$$

which is just the potential of the half-cell

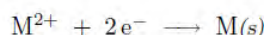

By carrying out a series of measurements in which various other systems are substituted for the M^{2+}/M couple, we can construct a table in which the various half-cell reactions are arranged in order of their potentials. The conventional way of doing this, as shown in Table 1, is to write the half-cell reactions as reductions, and to place them in the order of increasing (more positive) potentials. The resulting values are known as the *standard half-cell potentials*, denoted by E^0 .

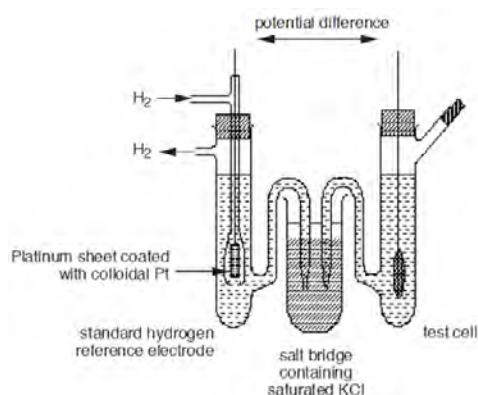

Figure 4: Cell for measurement of standard potentials

Table 1: Abbreviated table of standard reduction potentials

$Na^+ + e^- \rightarrow$	$Na(s)$	-2.71 v
$Zn^{2+} + e^- \rightarrow$	$Zn(s)$	-.76
$Fe^{2+} + e^- \rightarrow$	$Fe(s)$	-.44
$Cd^{2+} + e^- \rightarrow$	$Cd(s)$	-.40
$Pb^{2+} + 2e^- \rightarrow$	$Pb(s)$	-.126
$2H^+ + 2e^- \rightarrow$	$H_2(g)$	0.000
$AgCl(s) + e^- \rightarrow$	$Ag(s) + Cl^-(g)$	+.222
$Hg_2Cl_2(s) + 2e^- \rightarrow$	$2Cl^-(g) + Hg(l)$	+.2676
$Cu^{2+} + 2e^- \rightarrow$	$Cu(s)$	+.337
$I_2(s) + 2e^- \rightarrow$	$2I^-(s)$	+.535
$Fe^{3+} + e^- \rightarrow$	$Fe^{2+}(aq)$	+.771
$Ag^+ + e^- \rightarrow$	$Ag(s)$	+.799
$O_2(g) + 4H^+ + 4e^- \rightarrow$	$2H_2O(l)$	+1.23
$Cl_2(g) + 2e^- \rightarrow$	$2Cl^-(g)$	+1.36

Batteries

A **battery** is an electrochemical cell or series of cells that produces an electric current. In principle, any galvanic cell could be used as a battery. An ideal battery would never run down, produce an unchanging voltage, and be capable of withstanding environmental extremes of heat and humidity. Real batteries strike a balance between ideal characteristics and practical limitations. For example, the mass of a car battery is about 18 kg or about 1% of the mass of an average car or light-duty truck. This type of battery would supply nearly unlimited energy if used in a smartphone, but would be rejected for this application because of its mass. Thus, no single battery is “best” and batteries are selected for a particular application, keeping things like the mass of the battery, its cost, reliability, and current capacity in mind. There are two basic types of batteries: primary and secondary. A few batteries of each type are described next.

Primary batteries are single-use batteries because they cannot be recharged. A common primary battery is the dry cell (Figure). The dry cell is a zinc-carbon battery. The zinc can serves as both a container and the negative electrode. The positive electrode is a rod made of carbon that is surrounded by a paste of manganese(IV) oxide, zinc chloride, ammonium chloride, carbon powder, and a small amount of water. The reaction at the anode can be represented as the ordinary oxidation of zinc:

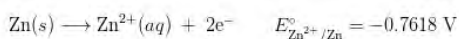

The reaction at the cathode is more complicated, in part because more than one reaction occurs. The series of reactions that occurs at the cathode is approximately

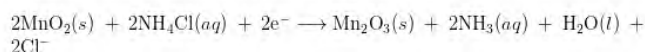

The overall reaction for the zinc-carbon battery can be represented as

$$2\text{MnO}_2(s) + 2\text{NH}_4\text{Cl}(aq) + \text{Zn}(s) \rightarrow \text{Zn}^{2+}(aq) + \text{Mn}_2\text{O}_3(s) + 2\text{NH}_3(aq) + \text{H}_2\text{O}(l) + 2\text{Cl}^{-}$$

with an overall cell



Alkaline batteries (Figure) were developed in the 1950s partly to address some of the performance issues with zinc-carbon dry cells. They are manufactured to be exact replacements for zinc-carbon dry cells. As their name suggests, these types of batteries use alkaline electrolytes, often potassium hydroxide. The reactions are;

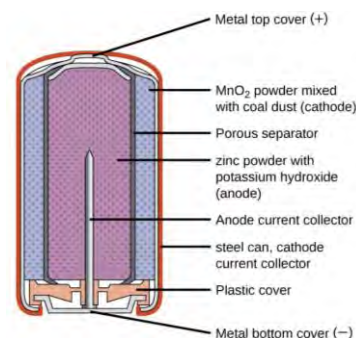
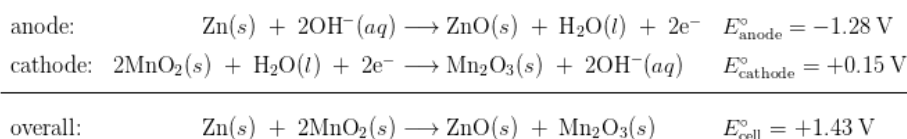

Secondary batteries are rechargeable. These are the types of batteries found in devices such as smartphones, electronic tablets, and automobiles.

Nickel-cadmium, or NiCd, batteries (Figure) consist of a nickel-plated cathode, cadmium-plated anode, and a potassium hydroxide electrolyte. The positive and negative plates, which are prevented from shorting by the separator, are rolled together and put into the case. This is a “jelly-roll” design and allows the NiCd cell to deliver much more current than a similar-sized alkaline battery. The reactions are

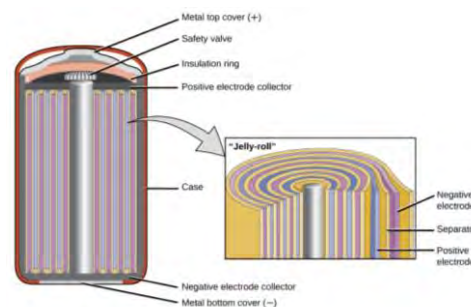
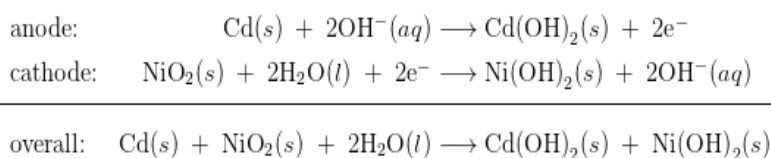

Lithium ion batteries (Figure) are among the most popular rechargeable batteries and are used in many portable electronic devices. The reactions are

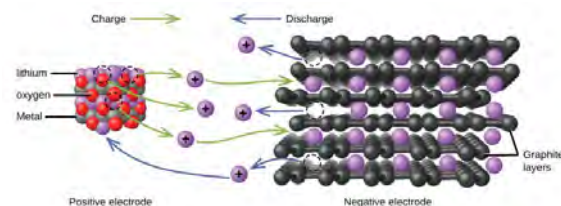
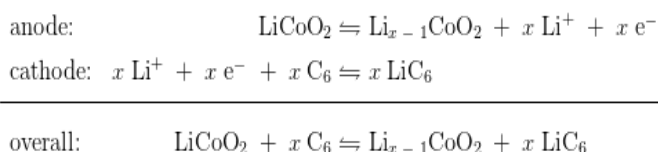

The lead acid battery (Figure) is the type of secondary battery used in your automobile. It is inexpensive and capable of producing the high current required by automobile starter motors. The reactions for a lead acid battery are;

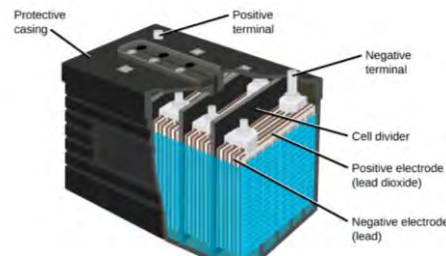
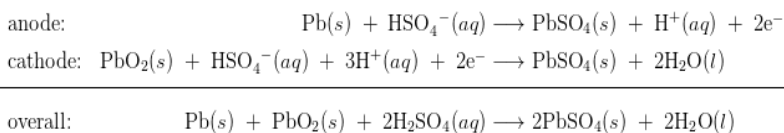

Fuel Cells

A fuel cell is a galvanic cell that requires a constant external supply of reactants because the products of the reaction are continuously removed. Unlike a battery, it does not store chemical or electrical energy; a fuel cell allows electrical energy to be extracted directly from a chemical reaction. In principle, this should be a more efficient process than, for example, burning the fuel to drive an internal combustion engine that turns a generator, which is typically less than 40% efficient, and in fact, the efficiency of a fuel cell is generally between 40% and 60%. Unfortunately, significant cost and reliability problems have hindered the wide-scale adoption of fuel cells. In practice, their use has been restricted to applications in which mass may be a significant cost factor, such as US manned space vehicles. These space vehicles use a hydrogen/oxygen fuel cell that requires a continuous input of $\text{H}_2(\text{g})$ and $\text{O}_2(\text{g})$, as illustrated in Figure. The electrode reactions are as follows:

The overall reaction represents an essentially pollution-free conversion of hydrogen and oxygen to water, which in space vehicles is then collected and used. Although this type of fuel cell should produce 1.23 V under standard conditions, in practice the device achieves only about 0.9 V. One of the major barriers to achieving greater efficiency is the fact that the four-electron reduction of $\text{O}_2(\text{g})$ at the cathode is intrinsically rather slow, which limits current that can be achieved. All major automobile manufacturers have major research programs involving fuel cells: one of the most important goals is the development of a better catalyst for the reduction of $\text{O}_2(\text{g})$.

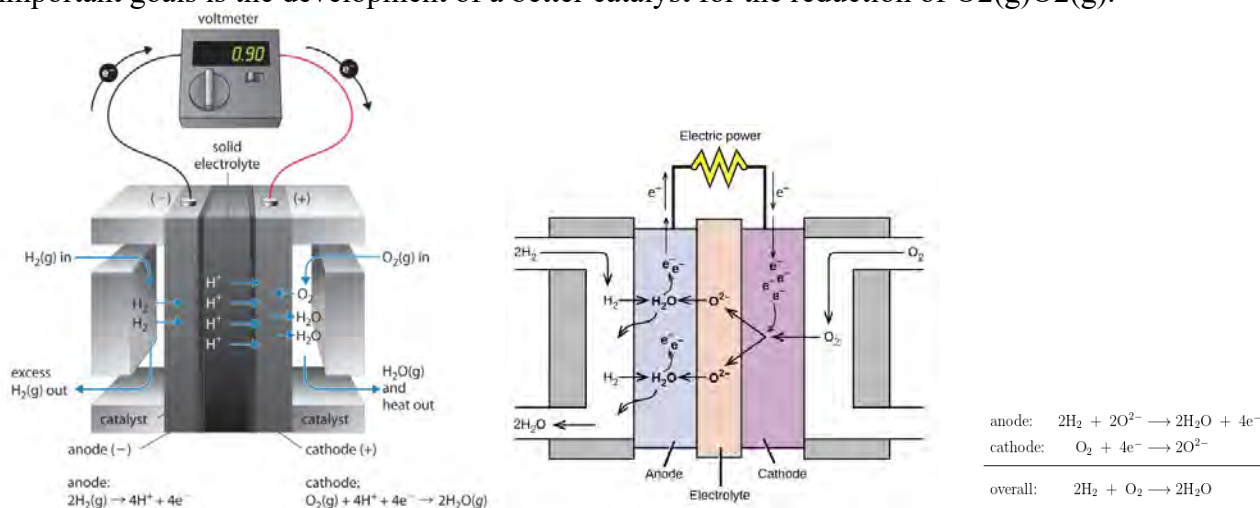

A fuel cell requires an external supply of reactants as the products of the reaction are continuously removed. In a fuel cell, energy is not stored; electrical energy is provided by a chemical reaction.

Question Bank
Department of Chemistry, BIT, Mesra
CH101: Chemistry
Module V: Phase and Chemical equilibrium

1. Discuss the following terms: Phase, Component, Degree of Freedom.
- 2.a. Calculate the number of components in the following systems:
 - i) $\text{KCl-NaCl-H}_2\text{O}$
 - ii) $\text{CaCO}_3(\text{s}) \rightarrow \text{CaO}(\text{s}) + \text{CO}_2(\text{g})$
- b. Calculate the number of degrees of freedom in the following systems
 - i) $2\text{KClO}_3(\text{s}) \rightarrow 2\text{KCl}(\text{s}) + 3\text{O}_2(\text{g})$
 - ii) An aqueous solution of sodium chloride
- c. What is the maximum degree of freedom for a:
 - i) Single component system.
 - ii) Pure substance under equilibrium.
5. Draw a neat phase diagram of water system, Discuss the behaviour of various equilibrium involved in the system with varying pressure and temperature. How does the melting point of ice change with the pressure and why?
6. What is condensed system? Why in such a case the phase rule equation is $F=C-P+1$?
7. Construct the phase diagram of lead-silver system and describe its use in understanding:
 - i) Eutectic point
 - ii) Desilverization of argentiferous lead
8. Define and compare the terms triple point and Eutectic point.
9. What is "reduced phase rule"? Explain the terms involved in it.
10. Give the cooling curves (not to scale- temp vs time) for the following:
 - i) 100% pure Ag
 - ii) 50% Pb & 50% Ag
 - iii) 97.4% Pb & 2.6% Ag
11. What is chemical equilibrium? Explain with example.
12. What are the characteristics of equilibrium state?
13. State and explain the law of chemical equilibrium.
14. What is equilibrium constant? What is K_p and K_c ? What are their significances?
15. What is the relation between K_p and K_c ?
16. What is the relation between equilibrium constant & Gibbs free energy? Hence explain about endothermic and exothermic reactions.
17. What are two types of chemical equilibrium? Explain about Homogeneous equilibria and Heterogeneous equilibria.
18. What is EMF? Describe the measurement of EMF of a cell.
19. Write short note on batteries.
20. Describe about primary and secondary batteries with example.
21. Write short note on;
 - (a) Zinc-carbon battery
 - (b) Alkaline battery
 - (c) Nickel-cadmium battery
 - (d) Lithium ion battery
 - (e) Lead acid battery
22. Describe the principle of fuel cell.